



30973 Santana St. Hayward CA 94544
www.extremeonlinestore.com
Tel: 1(669)-263-1011

Corvette C8

INSTALLATION MANUAL

2

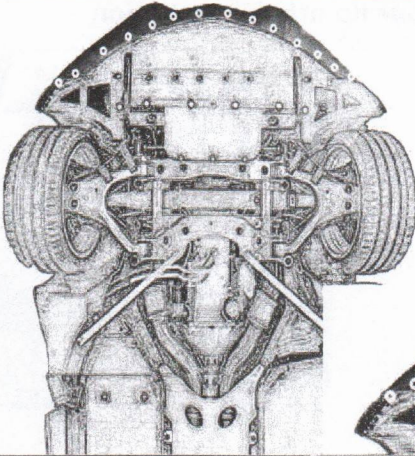

If you already have an existing splitter on your car, you may need to remove additional fasteners as shown

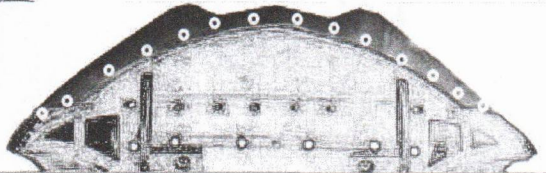

Using a 7MM socket to remove all the bolts circled in picture

3

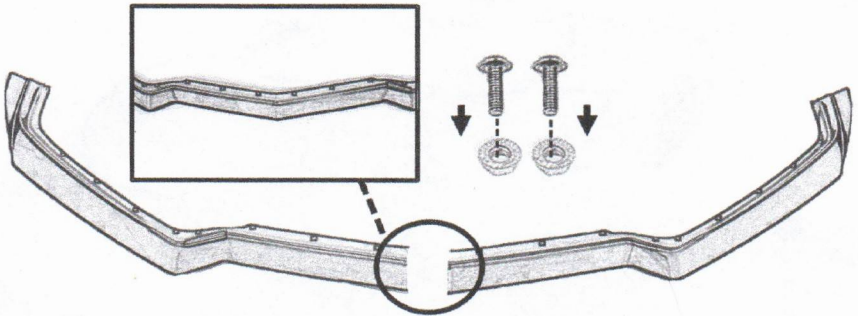

Using the nuts and bolts to connect the Lip.



30973 Santana St. Hayward CA 94544
www.extremeonlinestore.com
Tel: 1(669)-263-1011

Corvette C8

INSTALLATION MANUAL

Tips for protecting your lip after installation

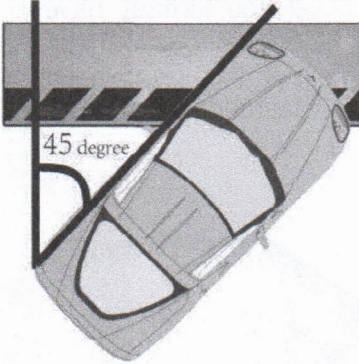

Take the approach at a 45 degree angle slowly when entering or leaving inclines/declines

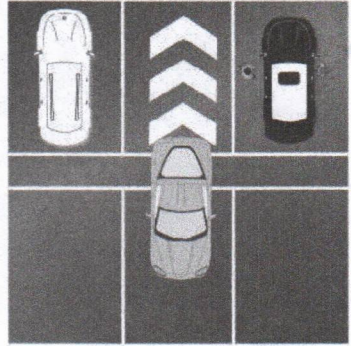

Always back up parking

1

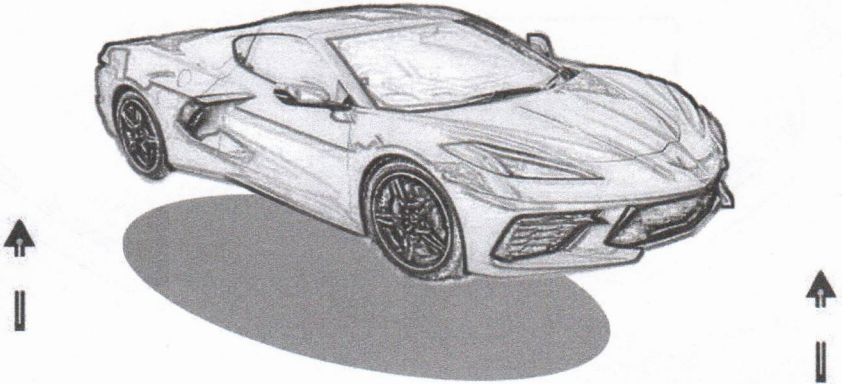

Raise vehicle to a comfortable working height



30973 Santana St. Hayward CA 94544
www.extremeonlinestore.com
Tel: 1(669)-263-1011

Corvette C8

INSTALLATION MANUAL

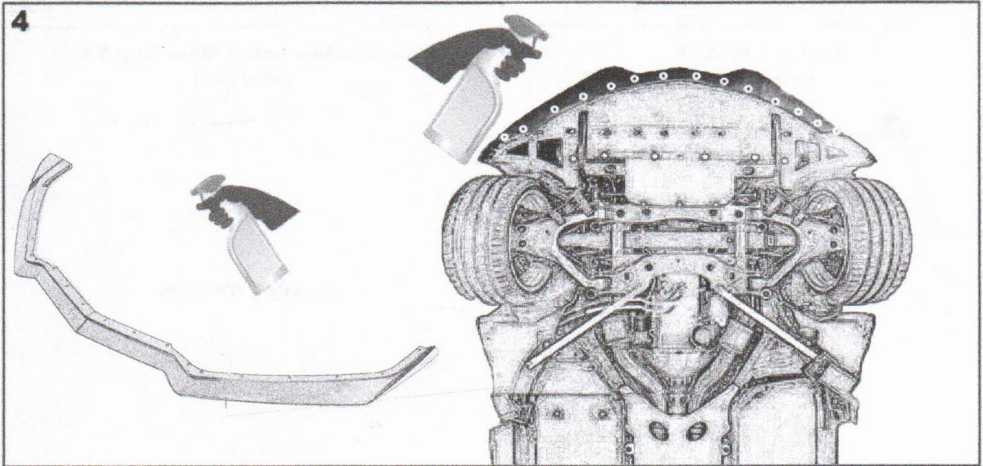

Clean the painted surface of the original part on the car. Ensure the underside portion is free of debris and residue.

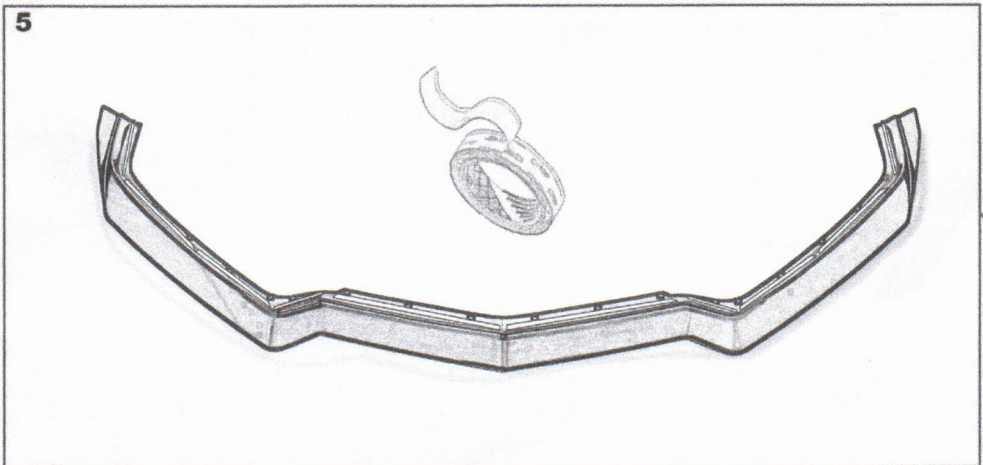

Attach 3M Double Sided Tape onto the front lip, avoid covering the Pre-drilled holes with the Tape.



30973 Santana St. Hayward CA 94544
www.extremeonlinestore.com
Tel: 1(669)-263-1011

TOOLS

INSTALLATION MANUAL

NUTS & BOLTS (provided)

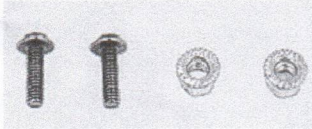

Auto Double-Sided Mounting Tape (provided)



Car jack

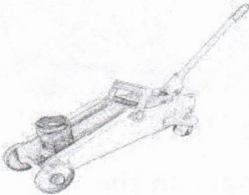

Socket Wrench

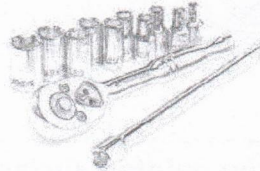

Screw Driver

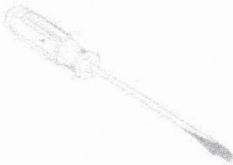

Auto Cleaner



Impact Drive





30973 Santana St. Hayward CA 94544
www.extremeonlinestore.com
Tel: 1(669)-263-1011

Corvette C8

INSTALLATION MANUAL

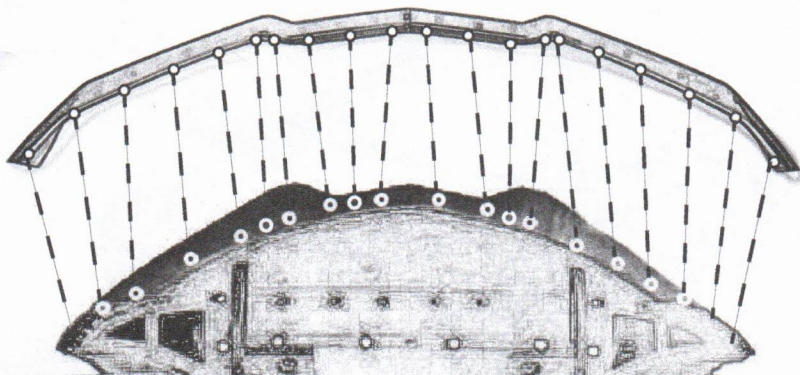
4

Reinstall OEM bolts from step 2 (we recommend to start from left to right). Install the screws but do not completely tighten them yet. Leave room for adjustments if needed.

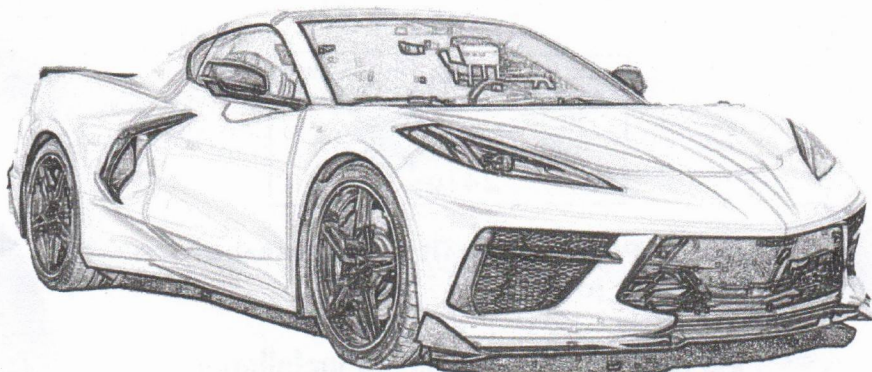
5

Do a visual inspection and make any final adjustments as necessary



30973 Santana St. Hayward CA 94544
www.extremeonlinestore.com
Tel: 1(669)-263-1011

Corvette C8

INSTALLATION MANUAL

Chevrolet Corvette C8 Stage 2 Front Splitter Installation Manual

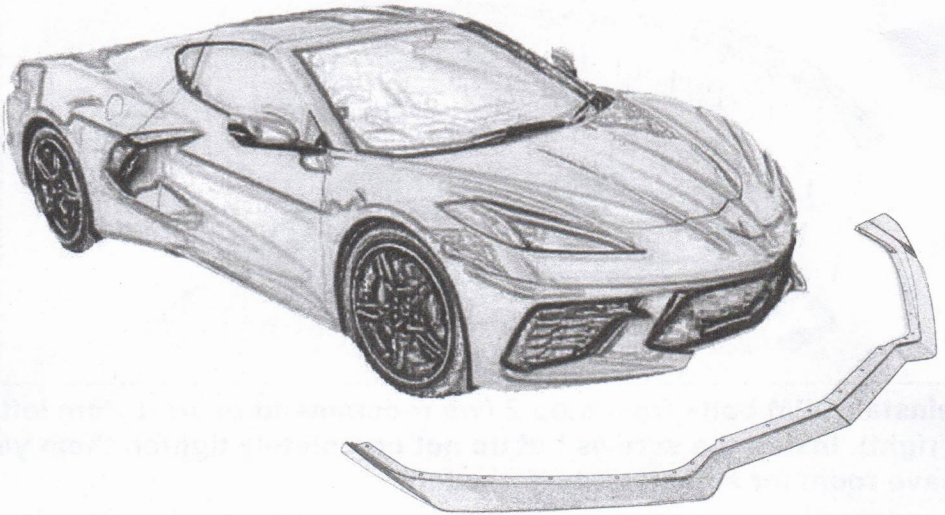

DO NOT WASH CAR		DRIVE SLOWLY
24 hrs		

WARNING!!! Please test fit the items before applying paint job.

We recommend 2 people for installation