



**IMPORTANT WARRANTY & INSTALLATION
INSTRUCTIONS ATTACHED**

*Please Forward All Attached Information to Consumer
Warranty Not Valid Unless Returned to CORSA Exhaust*

We ask that you take a few moments to complete our warranty registration form:

**TO ACTIVATE YOUR LIMITED LIFETIME WARRANTY GO TO:
CORSAPERFORMANCE.COM/WARRANTY**

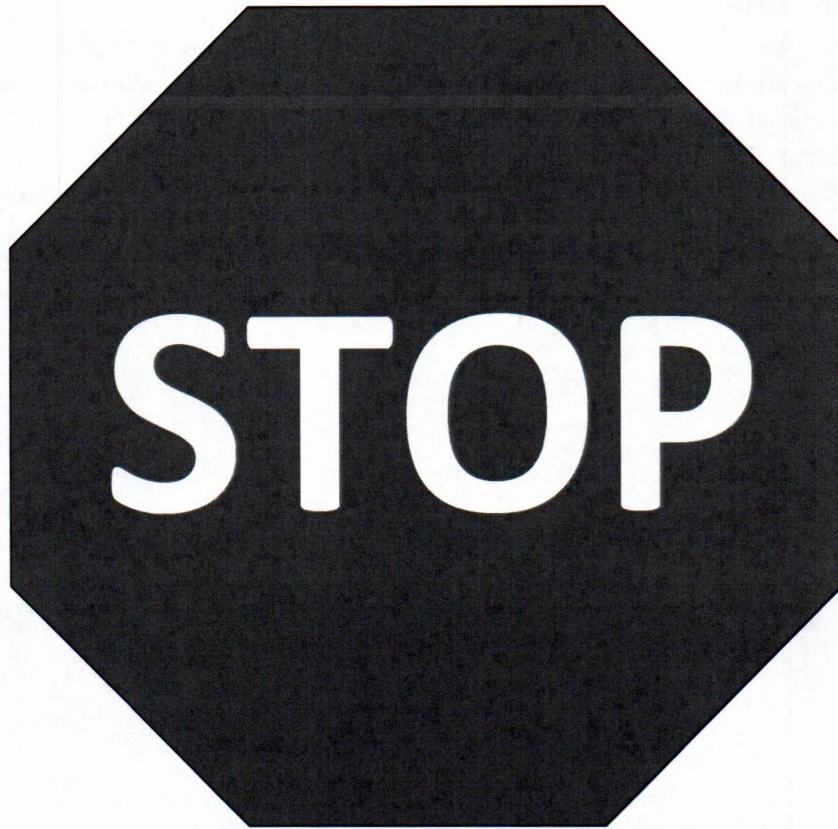

**For Full-Color Installation Instructions, Please Visit:
CORSAPERFORMANCE.COM and Search by Part Number**

Please be sure to review the enclosed instructions prior to beginning the installation process. If you have any questions about the enclosed parts, instructions or encounter a problem during installation:
CALL CORSA PERFORMANCE TECHNICAL ASSISTANCE AT 800.486.0999



Cat Back Exhaust System - Dual Rear Exit
2015+ Dodge Charger & Challenger 6.4L/6.2L &
2017+ Dodge Charger, Challenger & Chrysler 300 5.7L
 PN 14993, 14994, 14987/BLK, 14989/BLK, 14995/BLK, 14996/BLK, 21018
 21005/BLK, 21007, 21008, 21006/BLK, 21003/BLK, 21017, 21004/BLK,
 21092/BLK, 21093/BLK

Please take time to read and understand these installation instructions.

CORSA recommends that the installation of this system be performed by a qualified service center or professional muffler installer who has the necessary equipment, tools and experienced personnel. However, if you decide to perform this install, the use of a hoist and an additional person will be required.

NOTE: The installation of this CORSA Performance Exhaust system requires cutting and clamping onto the stock active valves. The presence of the active valves is needed to achieve the acoustic target of the system.

CAUTION: Never work on a hot exhaust system. Allow time for the vehicle to cool. Always wear eye protection when working under a vehicle.

Recommended Tools:

- 3/8" drive ratchet
- 3/8" drive long extension
- 3/8" drive swivel adapter
- 3/8" drive 13mm short socket
- 3/8" drive 15mm deep socket
- Grommet pullers
- Soap and water solution
- Torque Wrench
- Chain cutters
- File or deburring tool
- Safety glasses

Please confirm that all parts are present before beginning the factory exhaust system removal and CORSA exhaust system installation.

Challenger
Sport
 14987(BLK)
 14993
 21005(BLK)
 21007

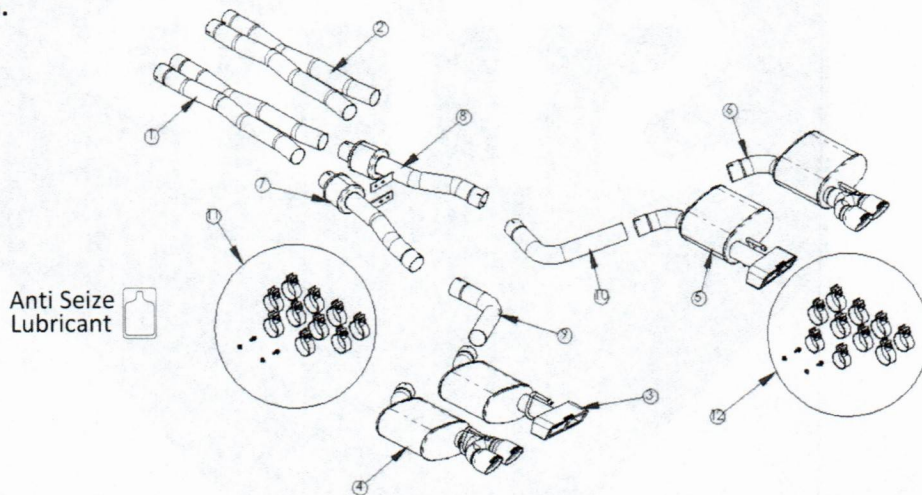

Anti Seize
 Lubricant

14987(BLK) Bill of Materials

1. 17CH4296 – X-PIPE ASSEMBLY CHALLENGER
4. 18LC2041 – REAR MUFFLER ASSEMBLY DRV (ROUND TIPS)
6. 18LC2042 – REAR MUFFLER ASSEMBLY PASS (ROUND TIPS)
11. 18LC7015 – HARDWARE KIT

14993 Bill of Materials

1. 17CH4296 – X-PIPE ASSEMBLY CHALLENGER
3. 18LC2023 – REAR MUFFLER ASSEMBLY DRV (GTX2 TIPS)
5. 18LC2024 – REAR MUFFLER ASSEMBLY PASS (GTX2 TIPS)
11. 18LC7015 – HARDWARE KIT

21005(BLK) Bill of Materials

2. 18LC4047 – X-PIPE ASSEMBLY CHALLENGER 5.7L
4. 18LC2041 – REAR MUFFLER ASSEMBLY DRV (ROUND TIPS)
6. 18LC2042 – REAR MUFFLER ASSEMBLY PASS (ROUND TIPS)
12. 18LC7019 – HARDWARE KIT

21007 Bill of Materials

2. 18LC4047 – X-PIPE ASSEMBLY CHALLENGER 5.7L
3. 18LC2023 – REAR MUFFLER ASSEMBLY DRV (GTX2 TIPS)
5. 18LC2024 – REAR MUFFLER ASSEMBLY PASS (GTX2 TIPS)
12. 18LC7019 – HARDWARE KIT

Shared Bill of Materials

7. 18LC2035 – TUNNEL MUFFLER ASSEMBLY DRV
8. 18LC2036 – TUNNEL MUFFLER ASSEMBLY PASS
9. 18LC4019 – AXLE PIPE ASSEMBLY DRV
10. 18LC4020 – AXLE PIPE ASSEMBLY PASS

Challenger

Xtreme

14989(BLK)

14994

21006(BLK)

21008

Anti Seize
Lubricant 

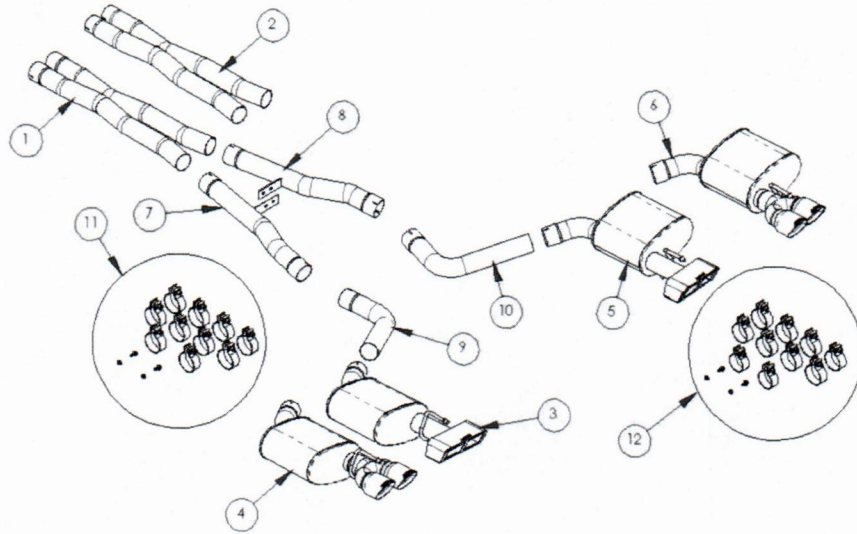

14989(BLK) Bill of Materials

1. 17CH4296 – X-PIPE ASSEMBLY CHALLENGER
4. 18LC2041 – REAR MUFFLER ASSEMBLY DRV (ROUND TIPS)
6. 18LC2042 – REAR MUFFLER ASSEMBLY PASS (ROUND TIPS)
11. 18LC7015 – HARDWARE KIT

14994 Bill of Materials

1. 17CH4296 – X-PIPE ASSEMBLY CHALLENGER
3. 18LC2023 – REAR MUFFLER ASSEMBLY DRV (GTX2 TIPS)
5. 18LC2024 – REAR MUFFLER ASSEMBLY PASS (GTX2 TIPS)
11. 18LC7015 – HARDWARE KIT

21006(BLK) Bill of Materials

2. 18LC4047 – X-PIPE ASSEMBLY CHALLENGER 5.7L
4. 18LC2041 – REAR MUFFLER ASSEMBLY DRV (ROUND TIPS)
6. 18LC2042 – REAR MUFFLER ASSEMBLY PASS (ROUND TIPS)
12. 18LC7019 – HARDWARE KIT

21008 Bill of Materials

2. 18LC4047 – X-PIPE ASSEMBLY CHALLENGER 5.7L
3. 18LC2023 – REAR MUFFLER ASSEMBLY DRV (GTX2 TIPS)
5. 18LC2024 – REAR MUFFLER ASSEMBLY PASS (GTX2 TIPS)
12. 18LC7019 – HARDWARE KIT

Shared Bill of Materials

7. 18LC4029 – TUNNEL PIPE ASSEMBLY DRV
8. 18LC4030 – TUNNEL PIPE ASSEMBLY PASS
9. 18LC4019 – AXLE PIPE ASSEMBLY DRV
10. 18LC4020 – AXLE PIPE ASSEMBLY PASS

Charger/300

Sport

14995(BLK)

21003(BLK)

21017

Anti Seize
Lubricant 

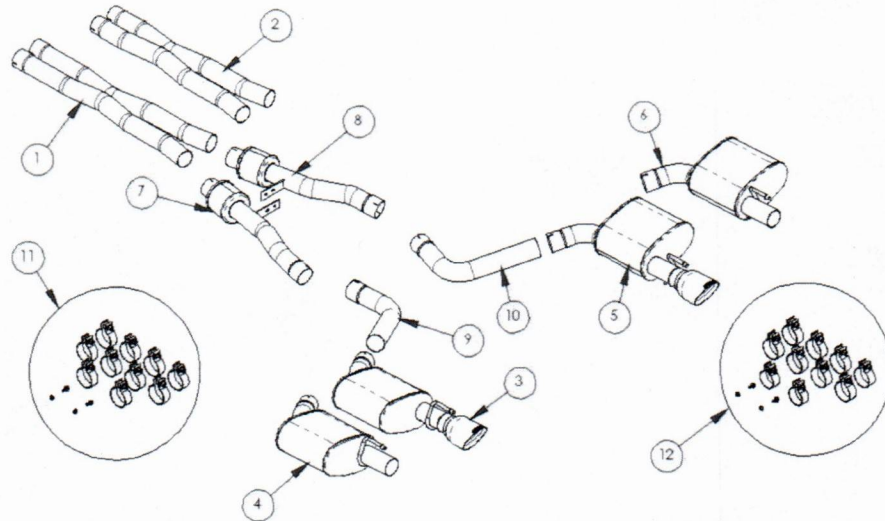

14995(BLK) Bill of Materials

1. 17CH4321 – X-PIPE ASSEMBLY CHARGER
3. 18LC2031 – REAR MUFFLER ASSEMBLY DRV
5. 18LC2032 – REAR MUFFLER ASSEMBLY PASS
11. 18LC7015 – HARDWARE KIT

21003(BLK) Bill of Materials

2. 18LC4045 – X-PIPE ASSEMBLY CHARGER
3. 18LC2031 – REAR MUFFLER ASSEMBLY DRV
5. 18LC2032 – REAR MUFFLER ASSEMBLY PASS
12. 18LC7019 – HARDWARE KIT

21017 Bill of Materials

2. 18LC4045 – X-PIPE ASSEMBLY CHARGER
4. 18LC2049 – REAR MUFFLER ASSEMBLY DRV
6. 18LC2050 – REAR MUFFLER ASSEMBLY PASS
12. 18LC7019 – HARDWARE KIT

Shared Bill of Materials

7. 18LC2035 – TUNNEL MUFFLER ASSEMBLY DRV
8. 18LC2036 – TUNNEL MUFFLER ASSEMBLY PASS
9. 18LC4019 – AXLE PIPE ASSEMBLY DRV
10. 18LC4020 – AXLE PIPE ASSEMBLY PASS

Charger/300

Xtreme

14996(BLK)
 21004(BLK)
 21018

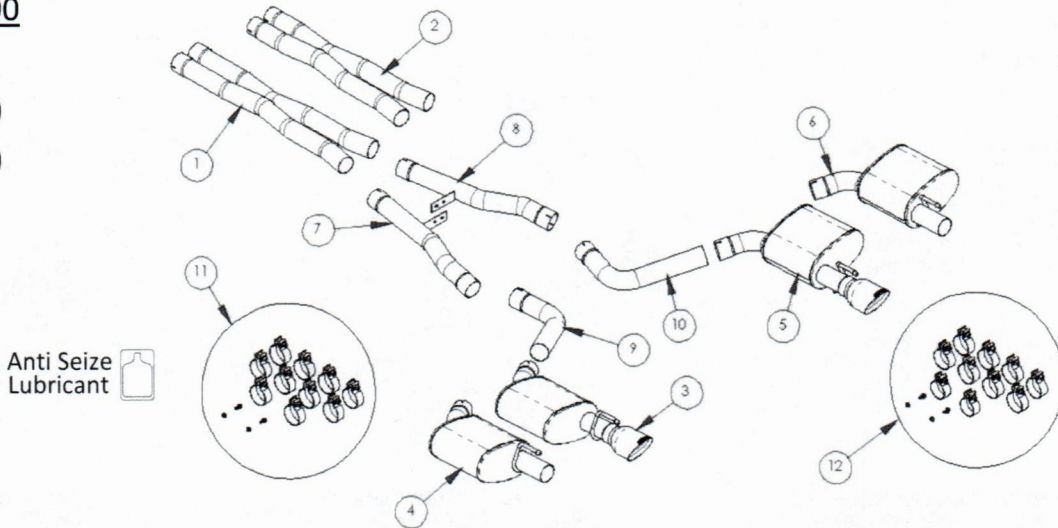

14996(BLK) Bill of Materials

1. 17CH4321 – X-PIPE ASSEMBLY CHARGER
3. 18LC2031 – REAR MUFFLER ASSEMBLY DRV
5. 18LC2032 – REAR MUFFLER ASSEMBLY PASS
11. 18LC7015 – HARDWARE KIT

21004(BLK) Bill of Materials

2. 18LC4045 – X-PIPE ASSEMBLY CHARGER
3. 18LC2031 – REAR MUFFLER ASSEMBLY DRV
5. 18LC2032 – REAR MUFFLER ASSEMBLY PASS
12. 18LC7019 – HARDWARE KIT

21018 Bill of Materials

2. 18LC4045 – X-PIPE ASSEMBLY CHARGER
4. 18LC2049 – REAR MUFFLER ASSEMBLY DRV
6. 18LC2050 – REAR MUFFLER ASSEMBLY PASS
12. 18LC7019 – HARDWARE KIT

Shared Bill of Materials

7. 18LC4029 – TUNNEL PIPE ASSEMBLY DRV
8. 18LC4030 – TUNNEL PIPE ASSEMBLY PASS
9. 18LC4019 – AXLE PIPE ASSEMBLY DRV
10. 18LC4020 – AXLE PIPE ASSEMBLY PASS

Challenger

Muffler

Delete

Cat Back

21092(blk)
 21093(blk)

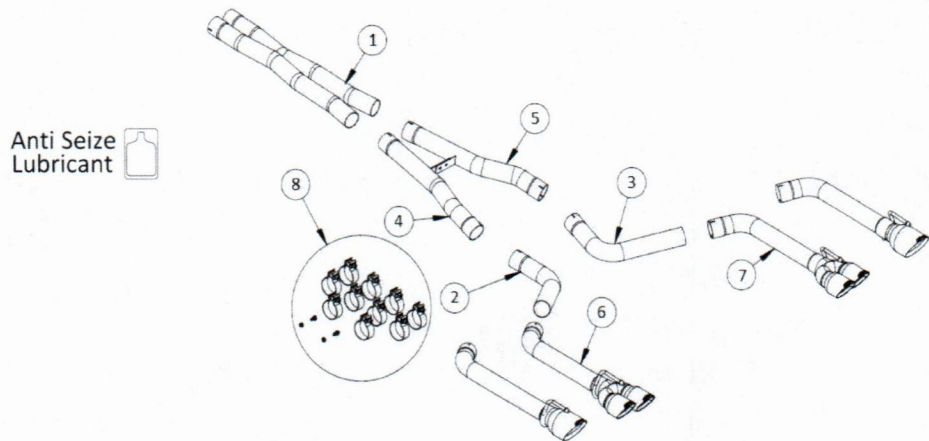

21092(BLK) Bill of Materials

1. 17CH4296 – SRT-8 X-PIPE ASSEMBLY
2. 18LC4019 – PIPE, AXLE DRIVER SIDE
3. 18LC4020 – PIPE, AXLE PASSENGER SIDE
4. 18LC4029 – TUNNEL PIPE, DRIVER SIDE
5. 18LC4030 – TUNNEL PIPE, PASS SIDE
6. 18LC4079 – MUFFLER DELETE, DRIVER SIDE
7. 18LC4080 – MUFFLER DELETE, PASSENGER SIDE
8. 18LC7015 – HARDWARE KIT

21093(BLK) Bill of Materials

1. 17CH4321 – X-PIPE ASSY, STR-8, 2.75"
2. 18LC4019 – PIPE, AXLE DRIVER SIDE
3. 18LC4020 – PIPE, AXLE PASSENGER SIDE
4. 18LC4029 – TUNNEL PIPE, DRIVER SIDE
5. 18LC4030 – TUNNEL PIPE, PASSENGER SIDE
6. 18LC4075 – MUFFLER DELETE, DRIVER SIDE
7. 18LC4076 – MUFFLER DELETE, PASSENGER SIDE
8. 18LC7015 – HARDWARE KIT

Factory Exhaust System Removal:

1. **Charger model ONLY** – Challenger model skip to step 2.
Using a 3/8" driver ratchet and a 13mm deep socket, remove the eight nuts holding up the front and rear chassis stiffening plates and remove the front and rear plates from the vehicle. **(Fig. A)**
2. Locate the driver and passenger side active valve modules located near the tunnel muffler exhaust hangers just in front of the rear differential. Disconnect both modules by pushing the tab on the top of the connector plugs and sliding the connector plugs upwards. **(Fig. B)**

NOTE: Do not start the vehicle or turn on the accessory power once the valves are unplugged, as this will trigger a check engine light.

3. Using grommet pullers or a similar device, remove the driver and passenger side tunnel muffler hangers from their corresponding hanger grommets. **(Fig. C)**

NOTE: The use of a soap and water solution may aid in the removal of hanger grommets.

4. Using a 3/8" drive ratchet and 15mm deep socket, loosen the driver and passenger side clamps at the cat-back connection point. **(Fig. D)**
5. Using a 3/8" ratchet, 13mm short socket, swivel adapter, and long extension, unbolt both the driver and passenger side front and rear hanger grommet assemblies from the vehicle chassis. Use jack stands or a similar device to support the front and rear of the exhaust while unbolting the grommet assemblies. The exhaust is heavy and will no longer be supported once the grommet assemblies are unbolted. **(Fig. E & F)**

NOTE: If your exhaust dumps into a "tip" built into the valence, there is a slight change in the process after step 5. In order to give you the ability to take the entire exhaust system down, you need to do Steps 5 - 7 from the install section on pg. 9 while the stock system is still on the car. You must cut the valve section area apart while the system is still on the car in order to allow the stock system the mobility to slide it forward out of the cup that the pipe dumps into, and to slide the mid-section off the connection point up front.

6. The stock exhaust can now be removed by sliding the system rearward to clear the overlapping pipe connection at the cat-back connection point; then lower the remaining portion of the stock exhaust system. **(Fig. G)**

NOTE: Depending on your vehicle year, your stock system may not have front rear muffler hangers.

7. Using grommet pullers or a similar device, remove the front and rear hanger grommet assemblies from the rear driver and passenger side mufflers. **(Fig. H & I)** Make note of the hanger grommet assemblies' orientation as they will be installed in the same position on the CORSA Performance exhaust system. Remove the ground wire from the rear passenger exhaust hanger. **(Fig. J)** This concludes the stock exhaust removal process.

REMOVAL PICTURES ON NEXT PAGE 

Factory Exhaust System Removal Pictures:

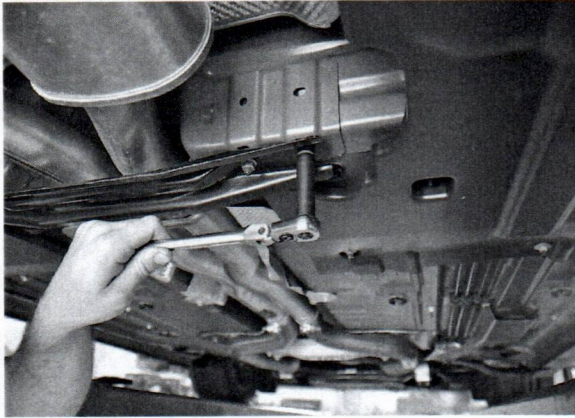

Fig. A

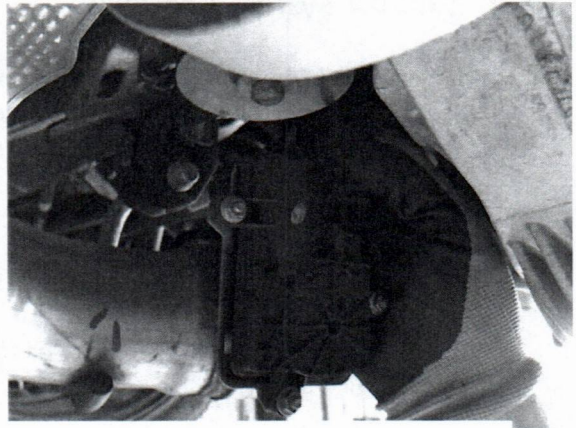

Fig. B

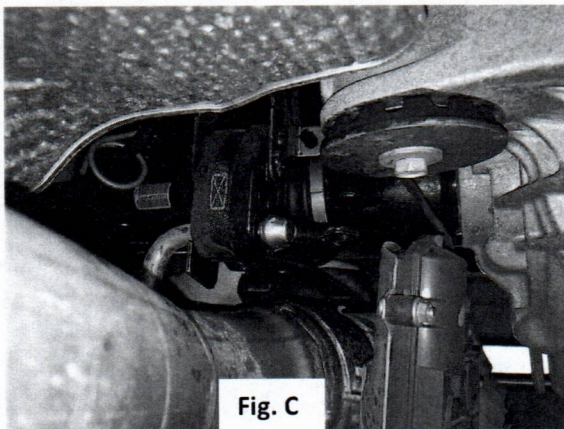

Fig. C

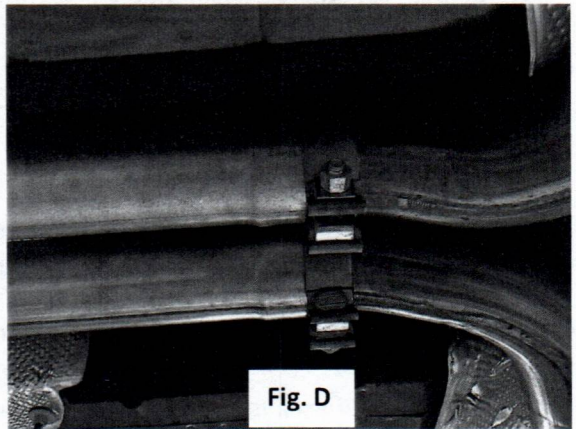

Fig. D

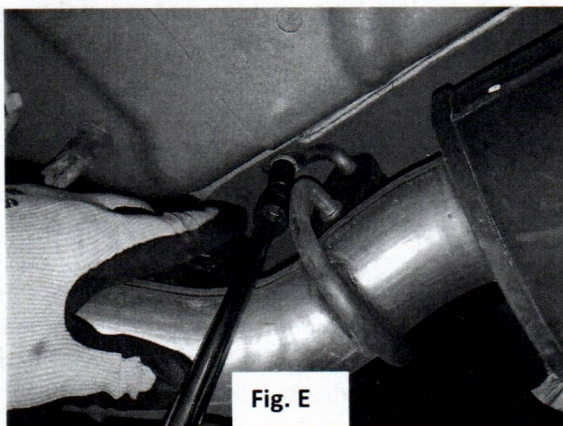

Fig. E

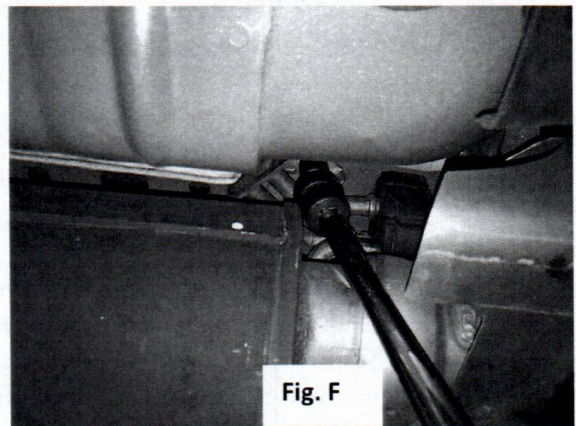

Fig. F

Factory Exhaust System Removal Pictures:

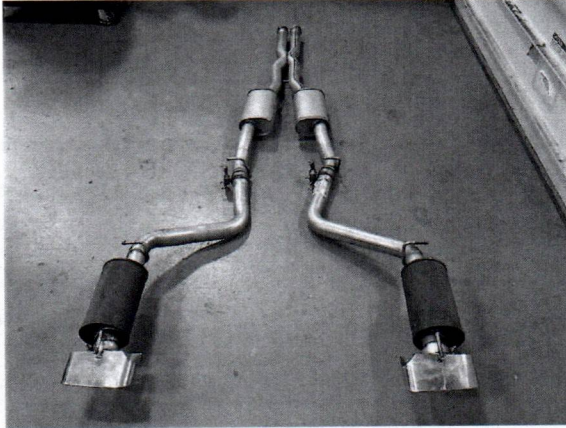

Fig. G

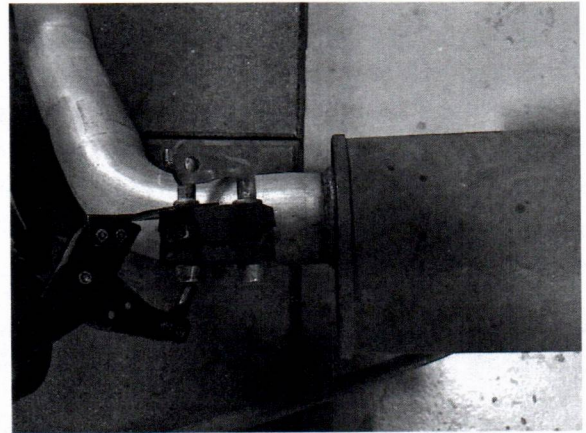

Fig. H

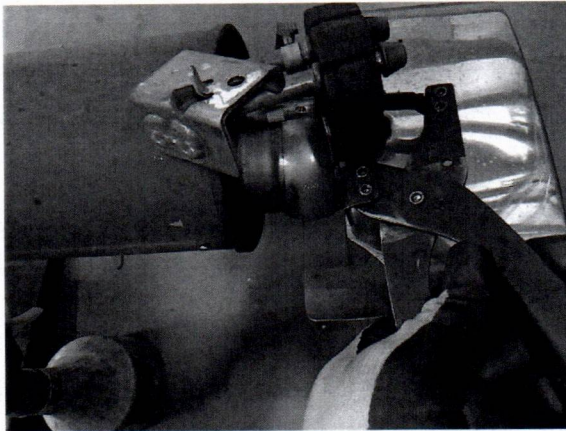

Fig. I

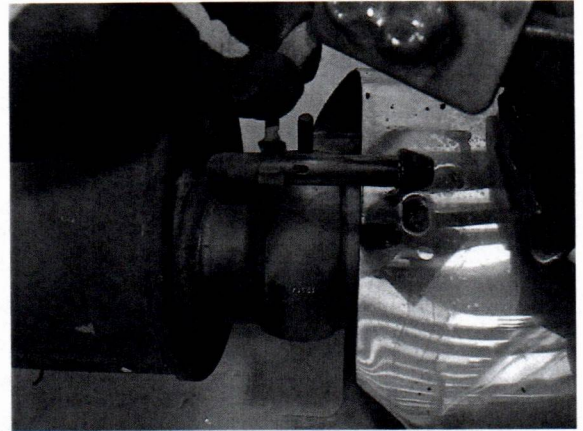
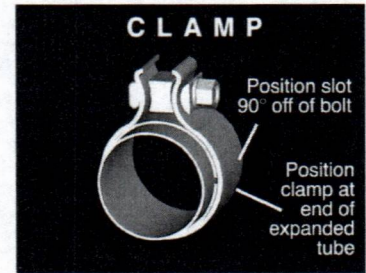

Fig. J

Installation of CORSA Exhaust System:

NOTE: Apply the anti-seize lubricant (supplied) to the threads **ONLY** of all the clamps and flange bolts. Failure to follow this procedure can cause nuts to seize on clamps and potentially destroy threads. After applying anti-seize lubricant, be sure to thoroughly clean your hands, as lubricant will tarnish stainless steel. All clamps should be tightened using a properly calibrated Torque Wrench. Using an air impact gun will damage the clamp and reduce its ability to effectively seal the joint. It may also cause the joint to separate, thereby causing damage to your exhaust system and to your vehicle.

NOTE: Align all clamps so that the center of the clamp bolt is 90 degrees from the notch in the pipe. (See Fig. CLAMP)



1. Remove all exhaust system components from the shipping boxes, including clamps and hardware.
2. Locate the x-pipe assembly and two 2.75" clamps. Install the clamps on the expanded inlet side of the x-pipe assembly so that the bolts are horizontal with the nuts towards the outside of the vehicle, with the x-pipe cross braces towards the bottom, slide the assembly over the stock exhaust pipes at the cat-back connection point. **(Fig. K)** Position the x-pipe assembly so that it is parallel with the ground and centered in the tunnel cavity; snug the clamps using a 15mm deep socket and ratchet. **(Fig. L)**
3. Next, locate the driver side tunnel muffler assembly and one 2.75" clamp. Install the clamp on the expanded inlet side of the tunnel muffler assembly as shown in Fig. P. Slide the tunnel muffler assembly over the driver side x-pipe outlet. **(Fig. M)** Position the brace so that it is parallel with the ground. After the driver side tunnel muffler has been installed, locate the passenger side tunnel muffler assembly and one 2.75" clamp. Install the clamp on the expanded inlet side of the tunnel muffler assembly as shown in Fig. P. Slide the tunnel muffler assembly over the passenger side x-pipe outlet with the brace parallel with the ground. **(Fig. N)**

NOTE: It's important to install the driver side tunnel muffler assembly first as the brace is offset further forward than on the passenger side to compensate for overlap.

NOTE: The driver and passenger side clamps will touch when not tightened. The clamps will pull in as they are tightened creating adequate clearance. **(Fig. P)**

INSTALLATION INSTRUCTIONS CONTINUED ON NEXT PAGE



4. Locate the stainless steel nuts and bolts in the hardware kit. Install and snug one of the two bolts through the slotted hole in the brace. With the second slot exposed, position the two braces so that the slots are aligned and tighten the nut and bolt. **(Fig. O)** Insert the second nut and bolt through the open slot and tighten the fasteners to 15 Ft-lbs. With the braces aligned and the bolts tightened, snug the clamps at the driver and passenger side tunnel muffler inlet connection points. **(Fig. P)**

5. **IMPORTANT:** Once the valves are cut and separated from the rest of the exhaust system, it is important not to confuse which valve belongs on which side. Next, the driver and passenger side active valve assemblies must be cut from the stock exhaust and reused. Scribe the raised portion of the driver side valve with a "D" and the passenger side valve with a "P" along with an arrow for the direction of flow. Starting at the rear of the driver side valve, measure and mark 4" from the raised valve assembly. **(Fig. Q)** On the rear of the passenger side valve, measure and mark 3 ¾" from the raised valve assembly. **(Fig. R)** Using chain cutters or a similar device cut the driver and passenger side exhaust pipes at the marked locations perpendicular to the pipes. **(Fig. S)** The rear mufflers will now be separated from the front exhaust section. **(Fig. T)** Deburr the cut edge using a file or deburring tool.

6. Measure and mark 8-5/8" from the driver side tunnel muffler endcap. The measurement should be taken from the flat endcap wall and not the endcap flange or weld. The measurement should also be marked at the very top of the pipe, with the tape measure following the slight bend profile of the exhaust pipe. **(Fig. U)** Using chain cutters or a similar device, cut the driver side exhaust pipe at the marked location perpendicular to the pipe. **(Fig. V)** The driver side valve assembly will now be free from the stock exhaust. Deburr the cut edge using a file of deburring tool.

CAUTION: A different and incorrect result will yield if the measurement is taken anywhere else other than the top section of the exhaust pipe.

7. Measure and mark 7 ½" from the passenger side tunnel muffler endcap. The measurement should be taken from the flat endcap wall and not the endcap flange or weld. Unlike the driver side measurement, the passenger side measurement should be taken from the inside center of the pipe rather than the top. **(Fig. W & X)** Using a chain cutter or similar device, cut the passenger side exhaust pipe at the marked location perpendicular to the pipe. **(Fig. Y)** The passenger side valve assembly will now be free from the stock exhaust leaving behind the stock x-pipe and rear mufflers. **(Fig. Z)** Deburr and cut edges using a file or deburring tool.

CAUTION: A different and incorrect result will yield if the measurement is taken anywhere else other than the inside center section of the exhaust pipe.

INSTALLATION INSTRUCTIONS CONTINUED ON NEXT PAGE 

8. Locate a 2.75" clamp and the driver side valve assembly. Verify the scribed "D" is present on the valve assembly. Install the clamp on the expanded outlet end of the driver side x-pipe outlet. Position the clamp so that the bolt is vertical with the nut towards the ground and the bolt towards the inside of the vehicle. Next, insert the driver side valve assembly hanger into the corresponding driver side tunnel hanger grommet. **(Fig. AA)** Then, slide the valve assembly into the expanded end of the x-pipe outlet. **(Fig. BB)** Rotate the valve assembly so that the hanger is parallel with the ground and the hanger grommet is swung forward. Using a 15mm deep socket and ratchet, snug the clamp.

NOTE: The active valve module should be facing the outside or driver side of the vehicle.

9. Locate a 2.75" clamp and passenger side valve assembly. Verify the scribed "P" is present on the assembly. Install the clamp on the expanded outlet end of the passenger side x-pipe outlet. Position the clamp so that the bolt is vertical with the nut towards the ground and the bolt towards the inside of the vehicle. Next, insert the passenger side valve assembly hanger into the corresponding passenger side tunnel hanger grommet. Then, slide the valve assembly into the expanded end of the x-pipe outlet. **(Fig. CC)** Rotate the valve assembly so that the hanger is parallel with the ground and the hanger grommet is swung forward. Using a 15mm deep socket and ratchet, snug the clamp.

NOTE: The active valve module should be facing the center or driver side of the vehicle.

10. Locate the passenger side axle pipe along with a 2.75" clamp. Install the clamp on the expanded end of the axle pipe. Position the clamp so that the bolt is vertical with the nut towards the ground and the bolt towards the outside of the vehicle. Slide the expanded end of the axle pipe over the passenger side valve assembly. **(Fig. DD)** Using a 15mm deep socket and ratchet, snug the clamp.

11. Repeat step #10 for the driver side of the vehicle.

12. Locate the passenger side rear muffler, a 2.75" clamp, the corresponding passenger hanger grommet assemblies removed from the stock exhaust removal process, and the two 13mm bolts for the hanger grommet assemblies. If present, install the front hanger grommet onto the front muffler hanger in the same position as removed from the stock exhaust. **(Fig. EE)** Next, install the rear hanger grommet onto the rear muffler hanger, again, in the same position as removed from the stock exhaust. **(Fig. FF)** Then, install the clamp on the expanded end of the rear muffler inlet pipe. Position the clamp so that the bolt is vertical with the nut towards the ground and the bolt towards the front of the vehicle. Slide the expanded end of the muffler inlet pipe over the passenger side axle pipe. Using a 13mm short socket, swivel adapter, 3/8" drive extension, and ratchet install the front and rear hanger grommet assemblies reusing the stock bolts. **(Fig. GG & HH)** On the passenger side only, clip the ground wire from the hanger grommet assembly onto the rear muffler hanger. **(Fig. II)** Using a 15mm deep socket and ratchet, snug the clamp. **(Fig. JJ)**

INSTALLATION INSTRUCTIONS CONTINUED ON NEXT PAGE 

13. Repeat step #12 for the driver side of the vehicle.
14. Connect both the passenger and driver side active valve modules. (Fig. KK)
15. **Charger model ONLY**
Locate the two chassis brackets and the hardware removed from step #1 of the stock exhaust removal process. Re-install the plates using a 3/8" drive ratchet and 13mm socket (Fig. LL) Torque to factory recommended value.
16. Check that the clearance to the suspension mounts are adequate on both sides. Make sure that the x-pipe is level and not rotated to one side, this will ease tip adjustment. Check clearance between the driver side axle pipe and the spare tire well.
17. Adjust the system accordingly, including the rear muffler depth and rotation, so that the exhaust tip outlets are centered in the bumper exhaust cutouts. (Fig. MM or NN) Check clearance between the system components and chassis. Confirm the passenger side axle pipe does not interfere with the heat insulated wires protruding from the spare tire well. At this time, tighten all clamps to 45ft-lbs using the torque wrench and 15mm socket. This concludes the CORSA Performance exhaust installation.

NOTE: Slightly loosening the rear muffler hanger assemblies from the vehicle chassis with allow side to side adjustment of the tips. Hold the tip centered in the valance cut out while a helper tightens the hanger grommet assemblies.

NOTE: During cold weather start-ups, you may experience an exhaust sound that is deeper and louder in tone than usual. This is temporary and will diminish to normal levels once your engine has reached its normal operating temperature.

NOTE: Immediately following the installation of your exhaust system, you may experience a trace of smoke after initial start-up. DO NOT be alarmed. The smoke is caused by the burning of a small amount of forming oil residue used in the manufacturing process.

INSTALLATION PICTURES ON NEXT PAGE



CORSA Installation Pictures

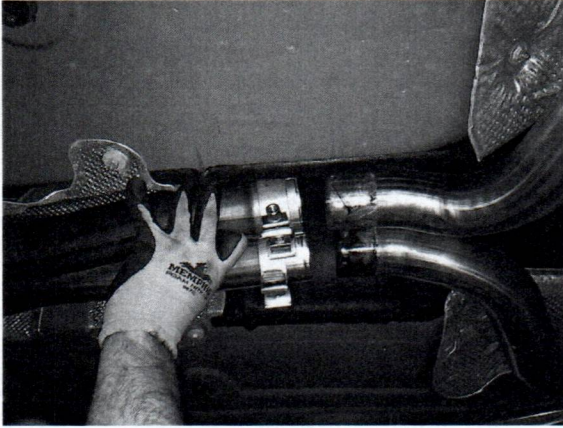

Fig. K

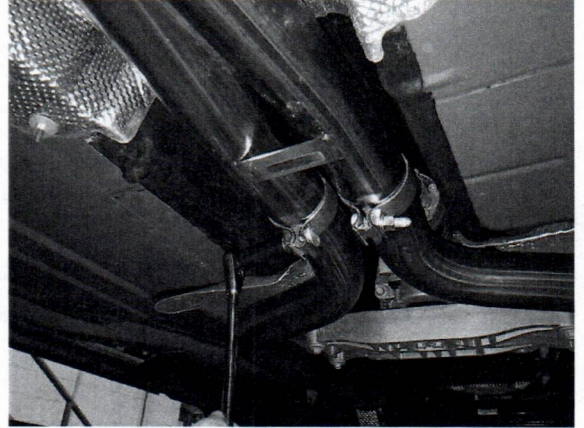

Fig. L



Fig. M

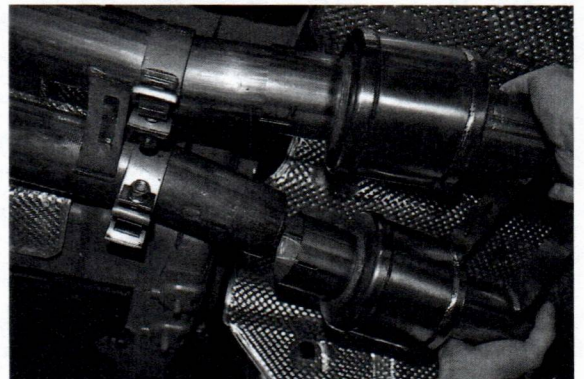

Fig. N

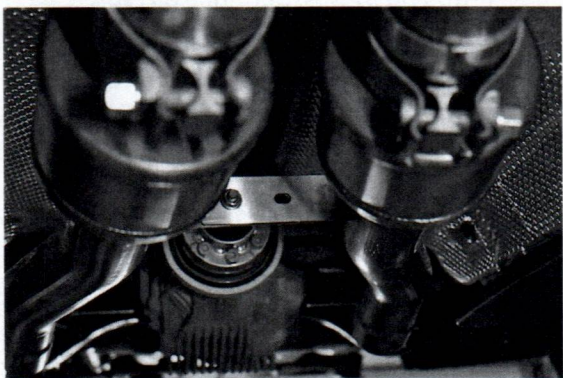

Fig. O

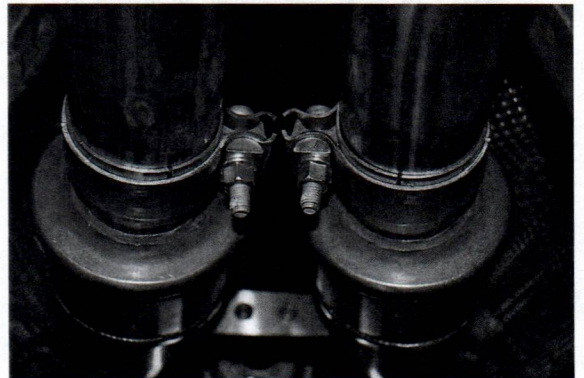

Fig. P

CORSA Installation Pictures

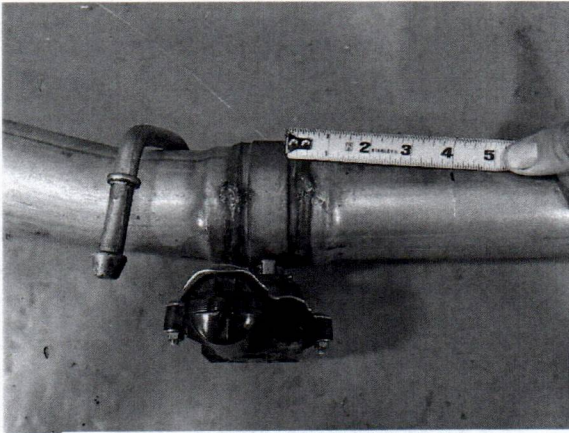

Fig. Q

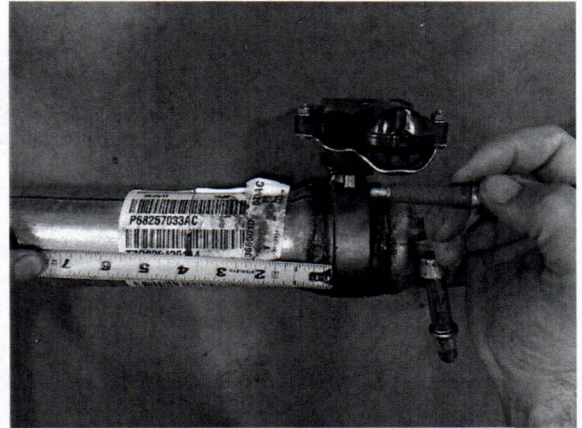

Fig. R

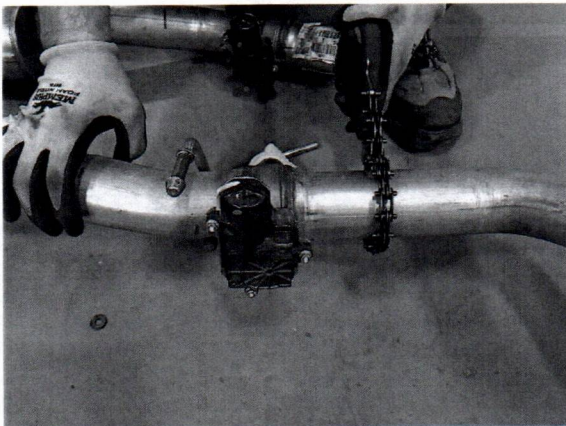

Fig. S

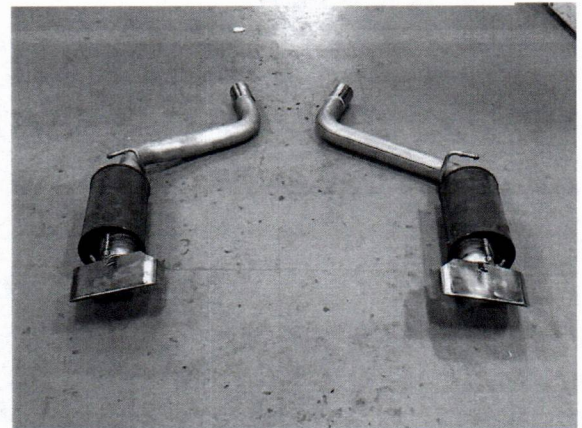

Fig. T

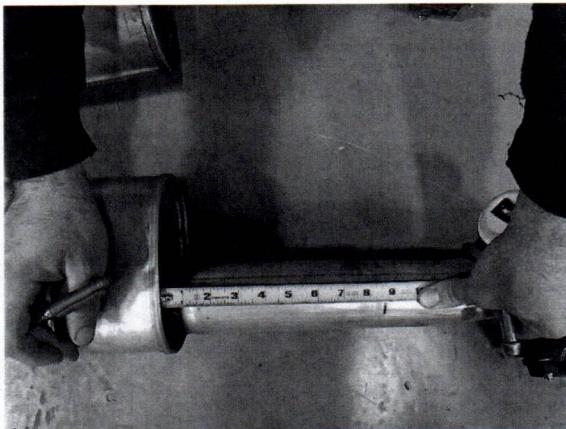

Fig. U

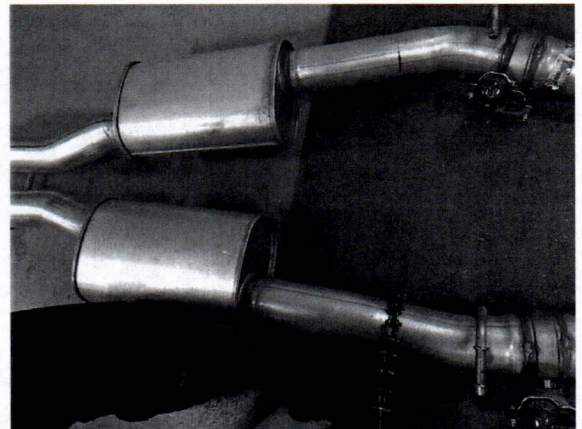

Fig. V

CORSA Installation Pictures

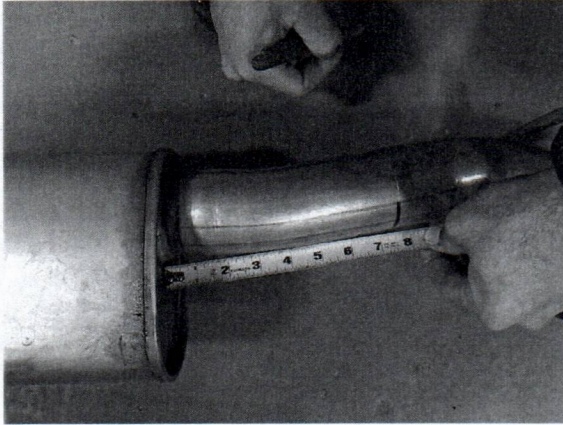

Fig. W

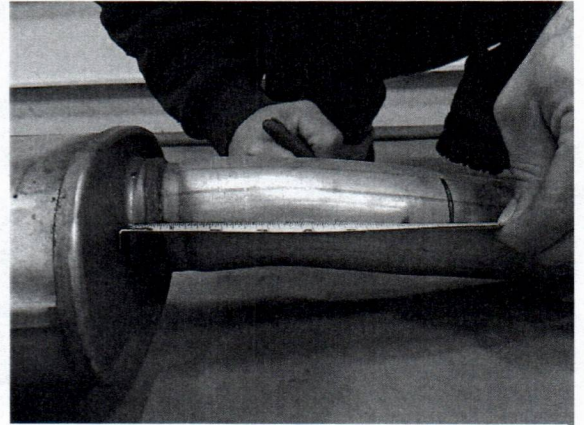

Fig. X

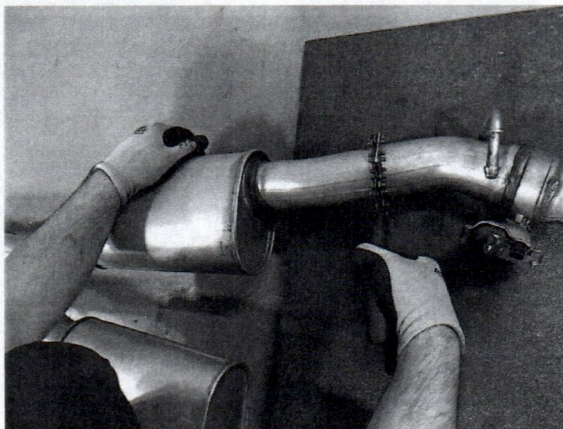

Fig. Y

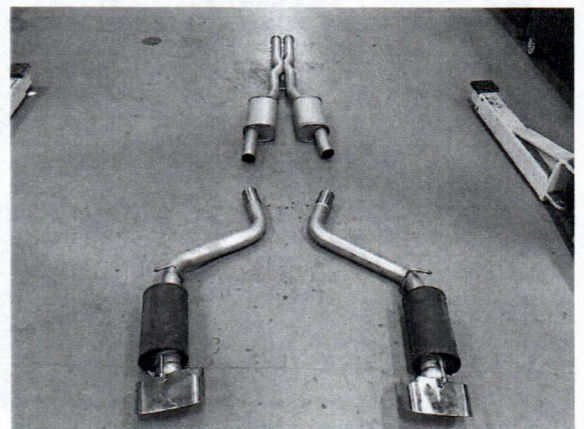

Fig. Z

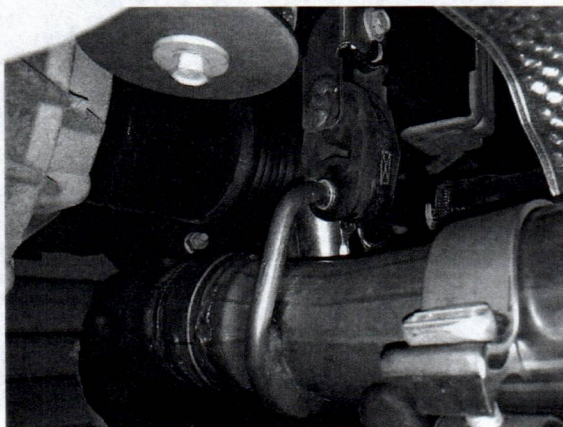

Fig. AA



Fig. BB

CORSA Installation Pictures



Fig. CC

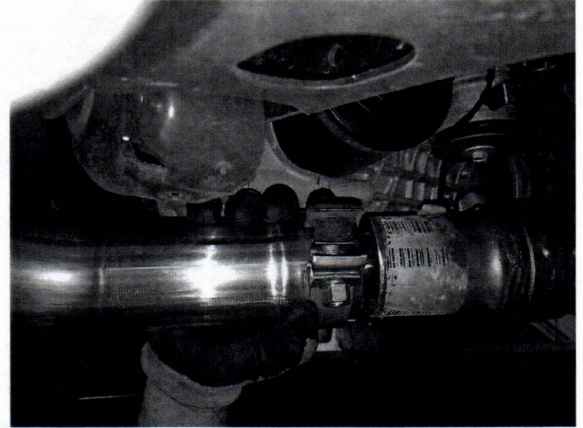

Fig. DD

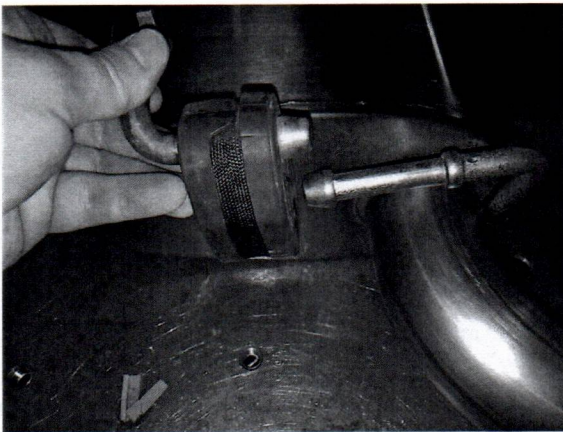

Fig. EE

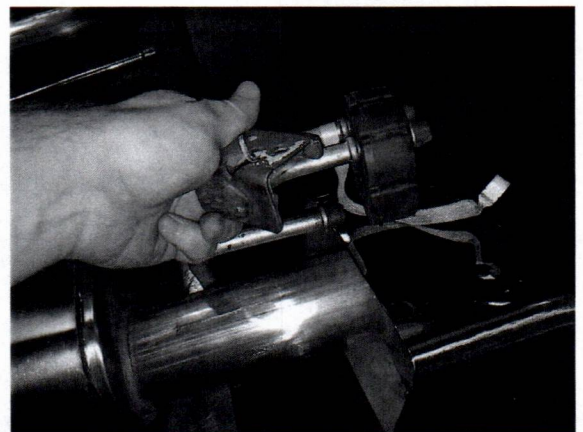

Fig. FF

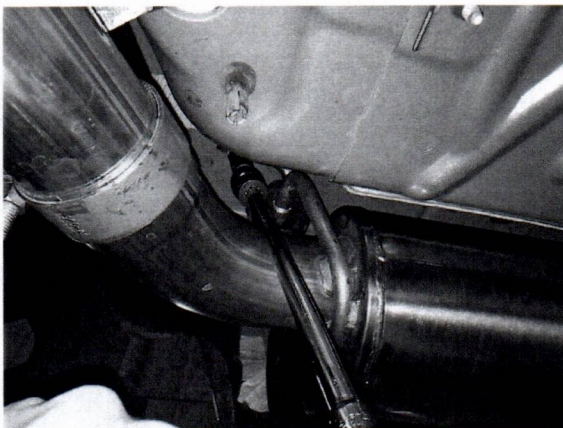

Fig. GG

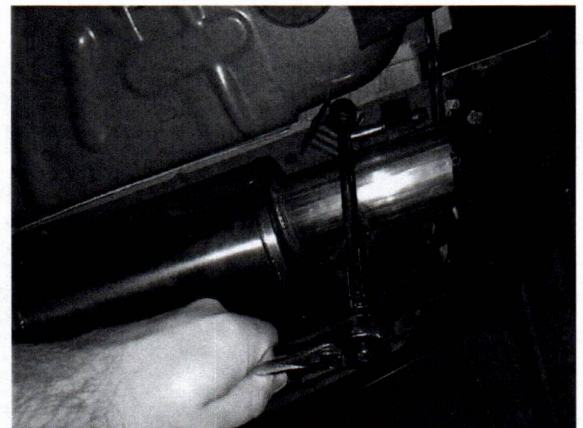

Fig. HH

CORSA Installation Pictures

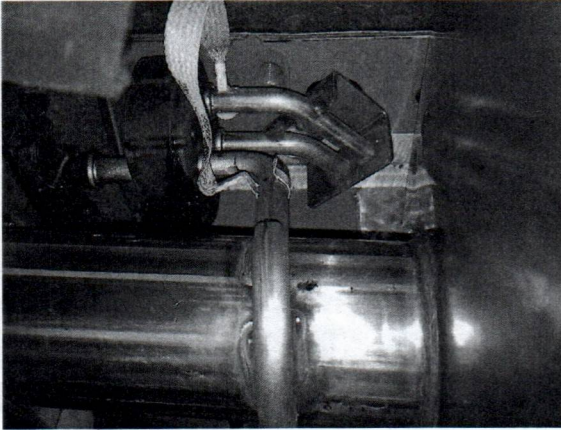

Fig. II

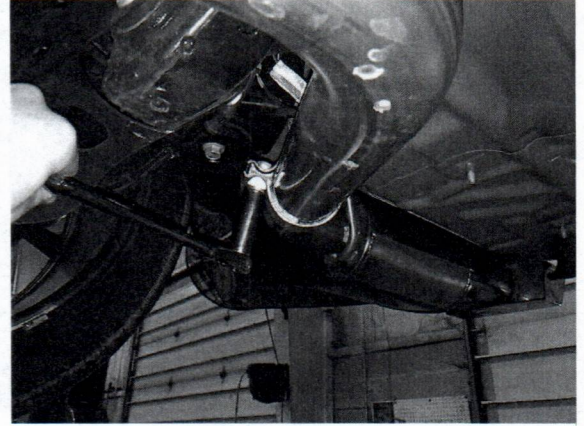

Fig. JJ

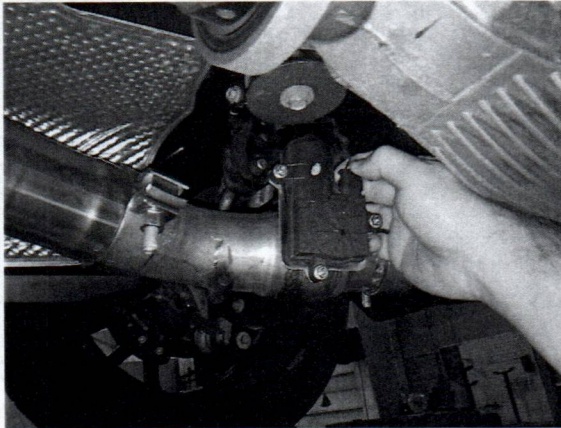

Fig. KK

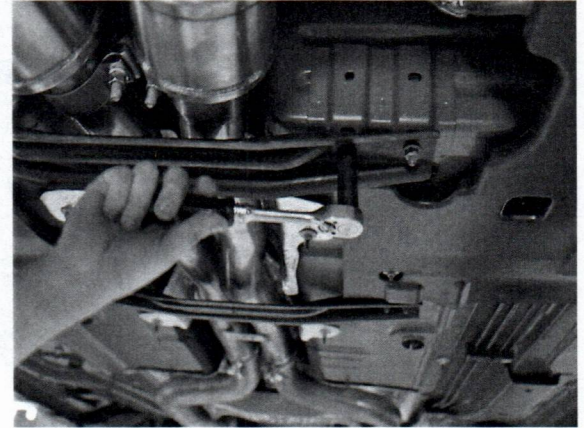

Fig. LL



Fig. MM

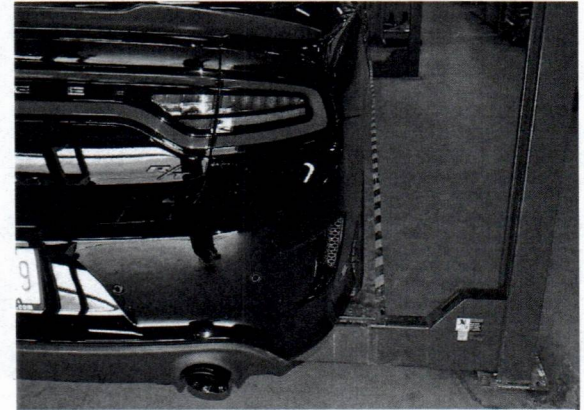

Fig. NN