

Installation Diagram  
**717904**  
2017-22 DODGE CHALLENGER R/T, T/A  
5.7L ENGINE  
Active Exhaust Valves

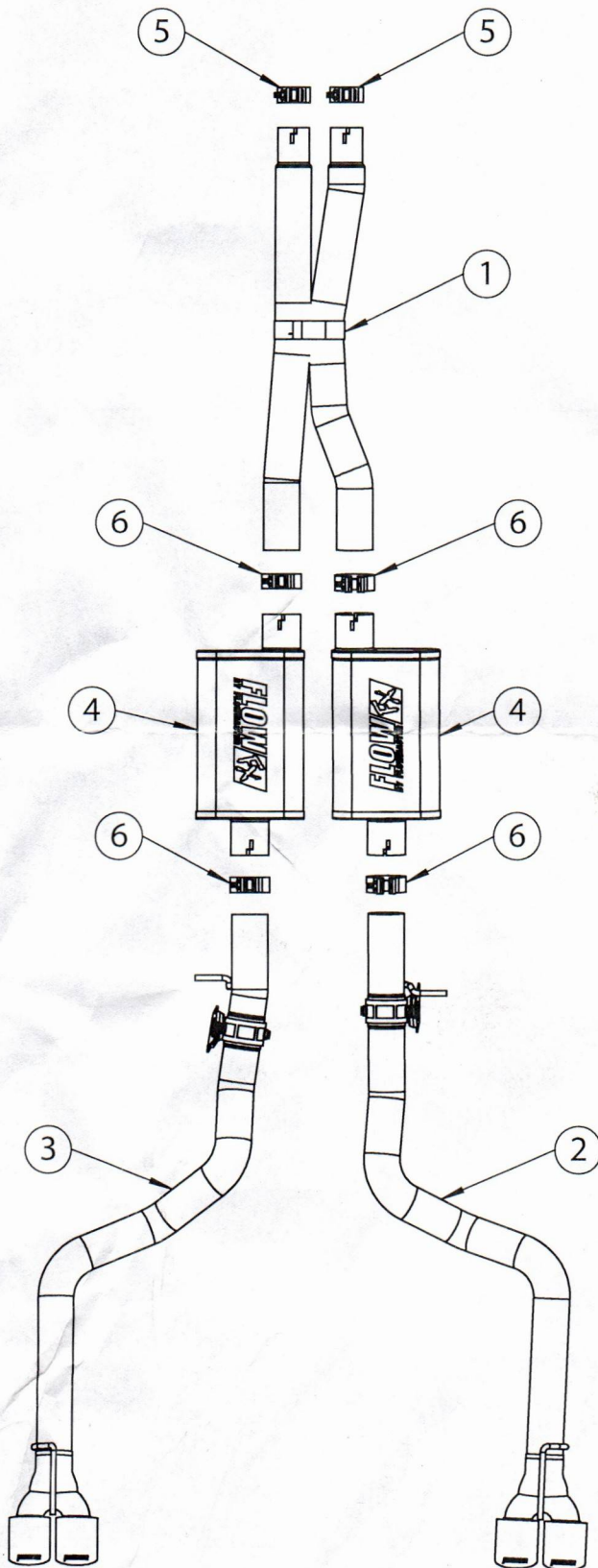

12. Place a **clamp (6)** onto **right (2)** and **left (3)** tailpipe then connect them to mufflers. Insert wire hangers into rubber isolators then adjust tailpipes so tips are level and centered in bumper cut-out. Tighten clamps just enough to allow for adjustment.

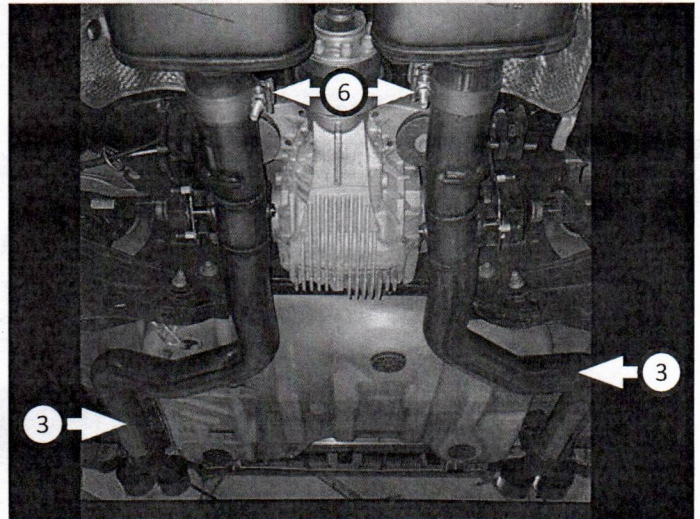

13. Reconnect (x2) exhaust valve actuators as shown.  
14. Adjust exhaust components for fit; maintaining 1/2" clearance and compensating for suspension, travel and vibration, then tighten all clamps. Finally, fit (x2) **hanger keepers (7)** onto each sideways hanger.  
15. Recommended: Secure slip-fit connections with a 1-inch tack weld then spray high-temp paint over each weld to prevent rust and premature corrosion.

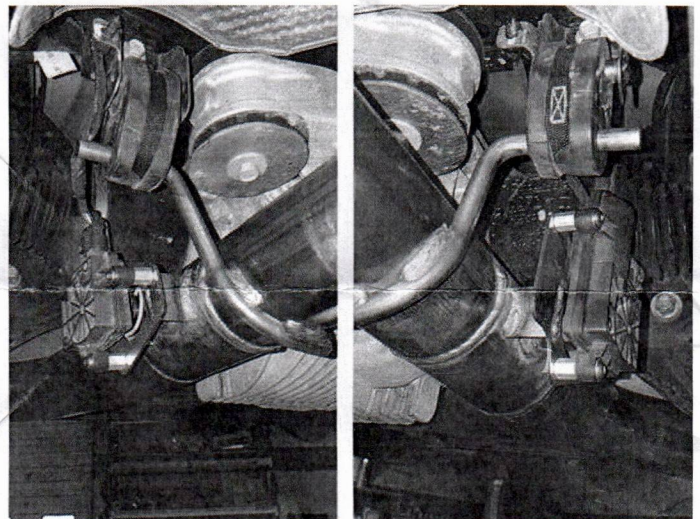

Congratulations, the installation of your FLOWMASTER performance exhaust system is now complete!



9. Insert (x3 ea.) **screws (10)** through actuator and **flat washers (11)**. Place actuator onto tailpipe valve mount then tighten screws to fasten assembly.

**NOTE:** Complete step for both tailpipe assemblies.

**CAUTION:** Make sure you place flat washer between actuator and standoff as shown, **NOT** beside screw head.

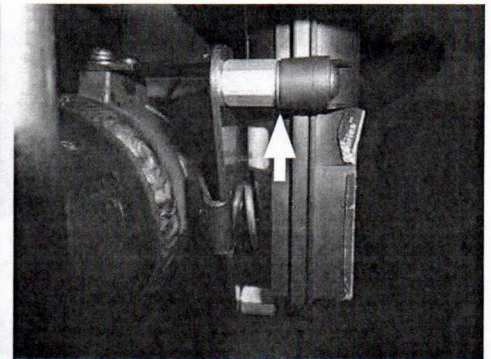
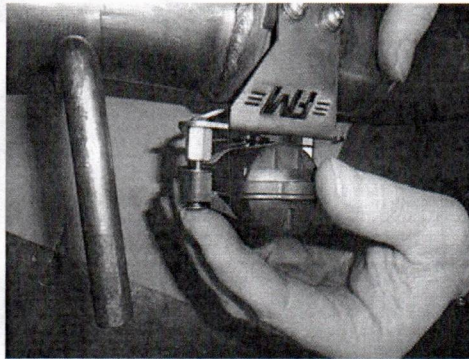
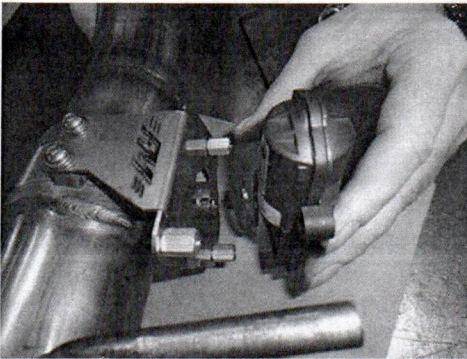

**NOTE:** Offset outlet pipe should be oriented to passenger side during install.

10. Place (x2) **clamps (5)** onto **scavenger pipe (1)** inlet then seat it in factory head pipes about 2". Level and center assembly in drive line tunnel and support with a stand. Tighten clamps just enough to allow for adjustment.

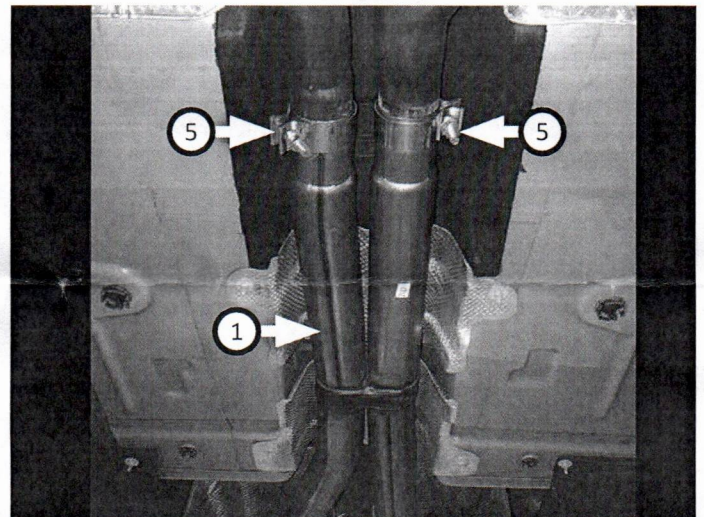

11. Place (x2) **clamps (6)** onto (x2) **muffler (4)** inlets. Slide mufflers onto scavenger pipe about 1 3/4" then level them. Tighten clamps just enough to allow for adjustment.

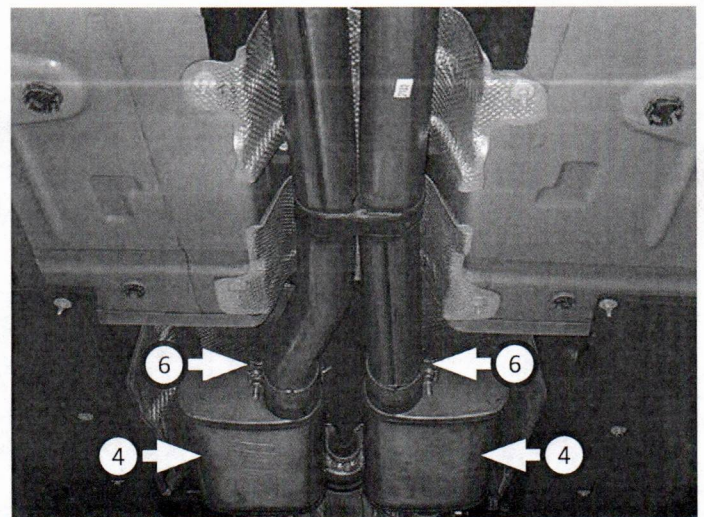

6. Locate factory exhaust mounts (x2) just forward of rear differential. Remove bolt securing hanger to frame, then lift hanger slightly to clear locating slot and rotate it 180 degrees. Lower hanger back into locating slot then install bolt.

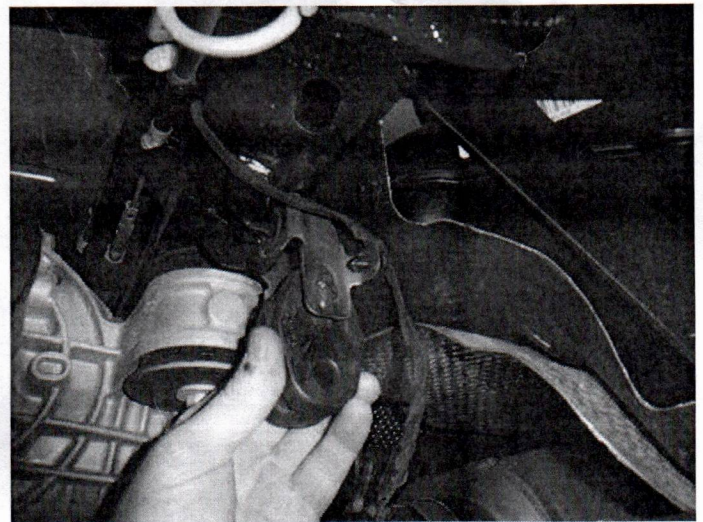
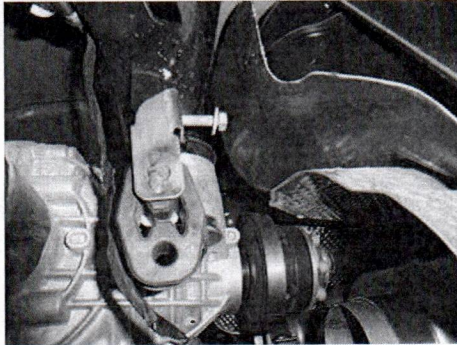

### INSTALL FLOWMASTER EXHAUST SYSTEM:

7. Remove nuts from stock and Flowmaster clamps, apply anti-seize compound to bolts and re-install nuts.

**NOTE:** The image in this step is intended for illustrative purposes only and may or may not accurately reflect components included in your kit.



8. Install (x3 ea.) screws (9) through mounting bracket into standoffs (8) as shown.

**NOTE:** Complete step for both tailpipe assemblies.

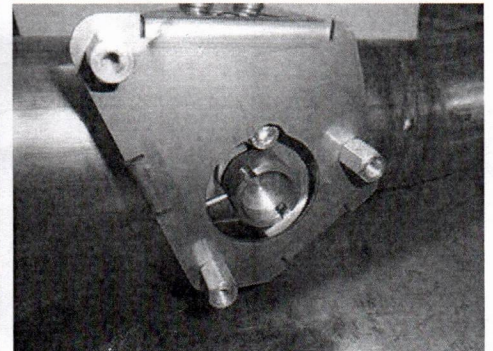
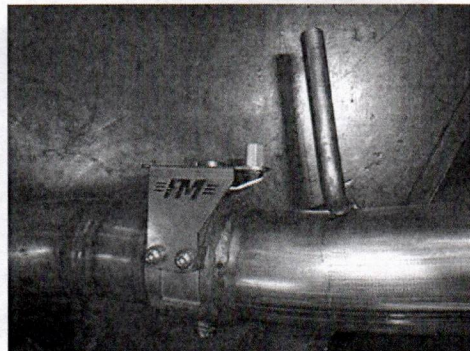
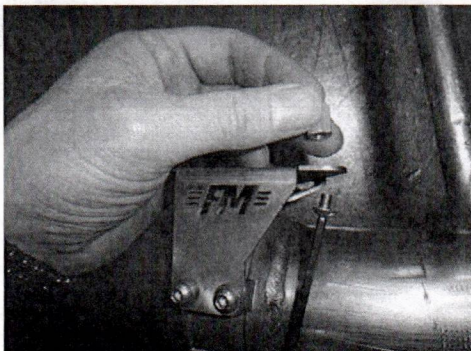

3. Unplug exhaust valve actuators (x2) on each tailpipe. Dismount wire hangers (x2) from rubber isolators and unclip grounding strap from right-side rear hanger. Loosen clamps securing exhaust to catalytic converters.

**NOTE:** If it is too difficult to slide a wire hanger out of its isolator, you may instead unbolt isolator mount and transfer it to your new system. Then, during install, re-bolt mount back onto your vehicle.

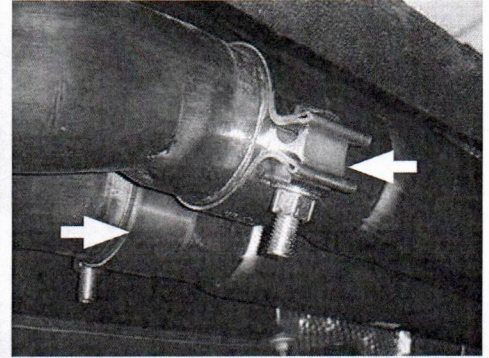
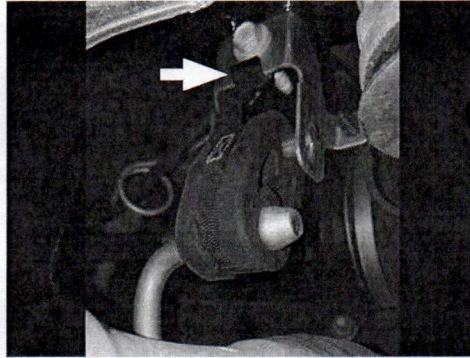
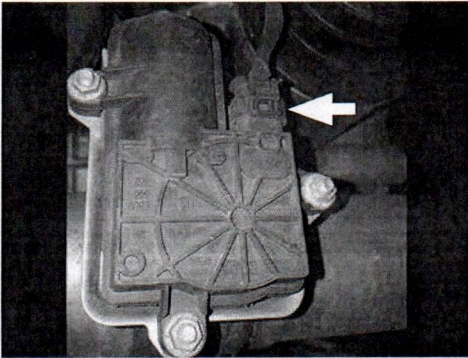

4. Carefully lower stands at vehicle rear and with help from an assistant, slide system back off the head pipes and lower system from vehicle.

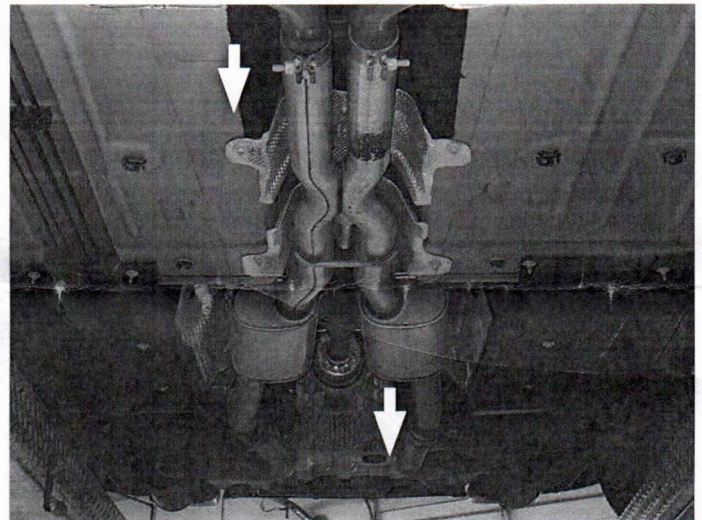

5. Remove nuts (x3) securing actuator to mounts on tailpipes. Then remove actuator and spring from mount on each tailpipe.

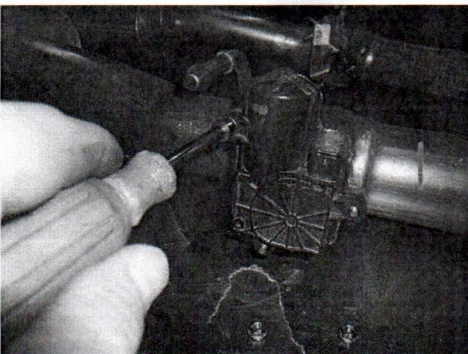



Installation Instructions  
**717904**  
**2017-22 DODGE CHALLENGER R/T, T/A**  
**5.7L ENGINE**  
 Active Exhaust Valves

**OVERVIEW:**

1. Take a moment to read and understand these instructions before installing your Flowmaster performance system.

**NOTE:** Please inventory all parts now before continuing and if necessary, report any missing items to our tech line. This will avoid potentially stranding your vehicle until any missing replacement parts arrive.

ITM #	PART #	DESCRIPTION	QTY.
N/A	PK868	Hardware Package includes:	1
5	MC250BS	2½" Stainless Band Clamp	2
6	MC300BS	3" Stainless Band Clamp	4
7	HW502	7/16" Hanger Keeper	2
8	HW512	10-32 x ½" Standoff	6
9	HW243	10-32 x ¼" Button Head Screw	6
10	HW240	10-32 x ¾" Button Head Screw	6
11	HW315	#10 Flat Washer	6

ITM #	PART #	DESCRIPTION	QTY.
1	26640M	Scavenger Pipe Assembly	1
2	26626M	Right Tailpipe Assembly	1
3	26628M	Left Tailpipe Assembly	1
4	71229-Z	Muffler	2

**REMOVE STOCK EXHAUST SYSTEM:**

2. Raise vehicle up on a hoist or rack to working height. If you don't have access to a hoist or rack, support vehicle with jack stands.

**WARNING:**

Avoid serious burns! Allow your vehicle time to cool completely before touching any factory engine components.

**To ease preparation and installation of your new kit:**

- Apply penetrating lubricant to mounts, bolts and clamps before you remove them.
- Use stands as necessary to support parts as you detach them from your vehicle and again as you install new parts.

