

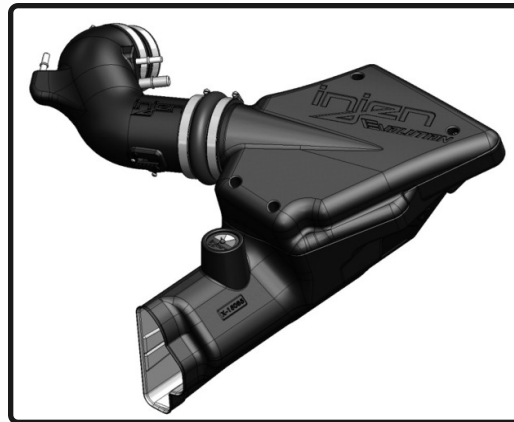

## EXPLODED VIEW

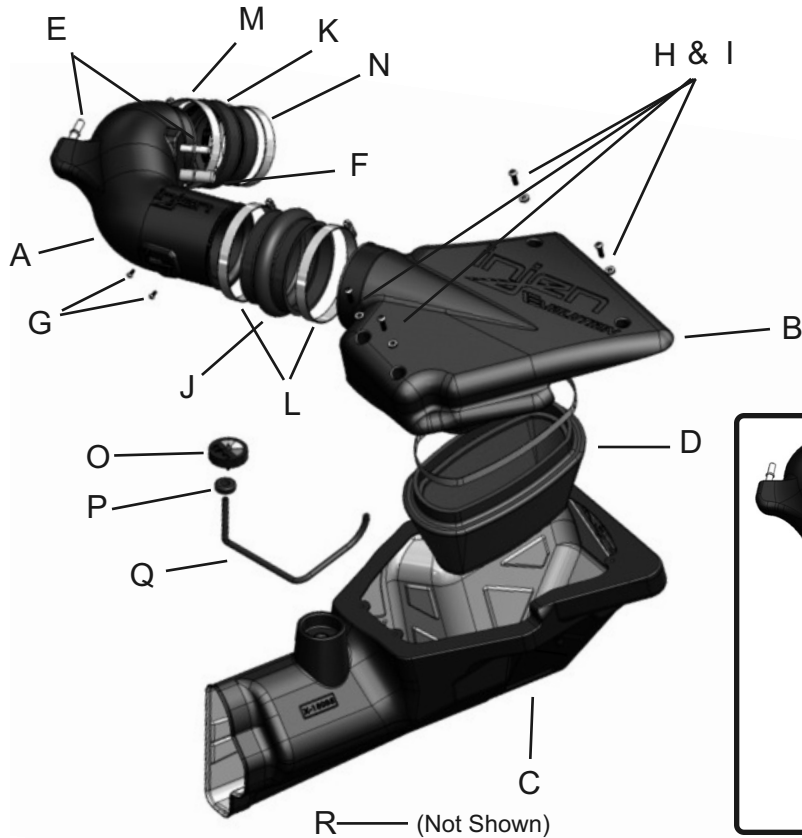

Vehicle Application:			
Make: <b>Ford</b>			
Model: <b>Mustang GT</b>			
Year: <b>2015</b>			
Engine: <b>5.0L V8</b>			

Item	QTY.	P/N	Discription
A	1	#15086	Intake Tube
B	1	#15084	Intake Plenum
C	1	#15085	Air box
D	1	#1084	Dry Air filter
E	2	#14064	Machined 3/8" Fitting
F	1	#14063	Machined 5/8" Fitting
G	2	#6047	M4x10mm button head screw
H	4	#6096	M6x30mm bolt
I	4	#8047	Rubberized washer
J	1	#3200	4.5" Hump hose
K	1	#3203	3.50"-4.00" Step Hose
L	2	#4014	#72 Clamps
M	1	#4008	#64 Clamp
N	1	#4004	#56 Clamp
O	1	#15040	Filter Minder
P	1	#8026	Grommet
Q	1	#3198	3mm Vacuum Line @ 15"
R	1	#8041	Vinyl Cap

TOOLS REQUIRED	
<ul style="list-style-type: none"> <li>• 10mm Ratchet &amp; Socket</li> <li>• 8mm nut drive</li> <li>• Allen key</li> <li>• Needle nose</li> <li>• Phillips Screwdriver</li> <li>• Pliers</li> </ul>	

**WARNING:** FAILURE TO FOLLOW INSTALLATION INSTRUCTIONS AND NOT USING THE PROVIDED HARDWARE MAY DAMAGE THE INTAKE SYSTEM, ENGINE AND COMPONENTS!!!  
**\*Do not attempt to install the intake system while the engine is hot.**  
 Severe burn could result from touching hot engine components!

Report any defective or missing parts to the authorized Injen dealer you purchased this product from. Before installing any parts of this system, please read the instructions thoroughly. If you have any questions regarding installation, please contact your Injen Technology dealer. Installation DOES require some mechanical skills. A qualified mechanic is always recommended.

A Limited Lifetime Warranty to the original purchaser against defects in material and workmanship on all Injen intake systems excluding the filter element. Any and all warranty coverage is limited to the repair or replacement of the defective part only, at Injen Technology's discretion. The warranty does not cover incidental or consequential damages, nor does it cover the cost of installation or removal of the defective part or its replacement. Proof of purchase is required.

# Instruction Manual P/N:EVO9201

Injen intake systems are street legal in most states unless the state is adopting to California Emissions standards. States that have adopted California emission standards include: Arizona, California, Connecticut, District of Columbia, Maine, Maryland, Massachusetts, New Jersey, New Mexico, New York, Oregon, Pennsylvania, Rhode Island, Vermont, and Washington. These states will require an California Air Resource Board Executive Order Number (CARB E.O.) for the legal use of an Injen intake system in your vehicle for use on public roads or highways. These vehicle will be considered "Legal in California only for racing vehicles competition use only, which may never be used upon a public street or highway. **Please keep your factory air box assembly for any future use.**

The SuperNano-Web filter media is a dry synthetic media that outperforms the competition. The media itself is a proprietary base blend of synthetics and cellulose. Cellulose fibers are larger than synthetic fibers, and have larger spaces between the fibers, causing contaminants to load in the depth of the media and plug the airflow path. This creates higher restriction levels and less capacity. The synthetic fibers in the SuperNano-Web media are submicron in diameter and have small interior fiber spaces, which result in more contaminants being captured on the surface of the media. This can help keep restriction levels low as the filter loads with dirt and containments



If you look at the picture to the left, you can see the Nano-fiber web on top of our base media. That web, or Super-Nano-Web as we like to call it, helps trap smaller particles and protect your engine.

## **To Clean your filter:**

Carefully remove the filter from the housing. Once removed, wipe down the housing using a clean shop towel, being careful not to knock any dirt and/or debris in the air inlet. Your filters can be cleaned by carefully vacuuming the filter media from the dirty side, or by holding the filter with one hand and carefully blowing the filter media at a 45-degree angle from the clean side using low-pressure shop air (15-20 lbs. psi).

***\*IT IS IMPORTANT TO NOT USE ANY CLEANERS ON THE SUPERNANO-WEB MEDIA OR APPLY ANY OIL!!!***

**NOTE: DISCONNECT BATTERY BEFORE INSTALLATION!!!**



1. Stock intake system shown.



2. Disconnect the three vacuum lines and sound tube from the factory intake air duct.



3. Remove the engine cover.



4. Loosen the two clamps on the factory air duct and then disconnect and remove from engine bay. Also disconnect the MAF sensor harness.



5. Remove the 10mm bolt from the OE air box assembly and then remove the entire OE air box assembly from the engine bay.



6. Disconnect the sound tube resonator box.



7. Place the Vinyl cap onto the sound valve.

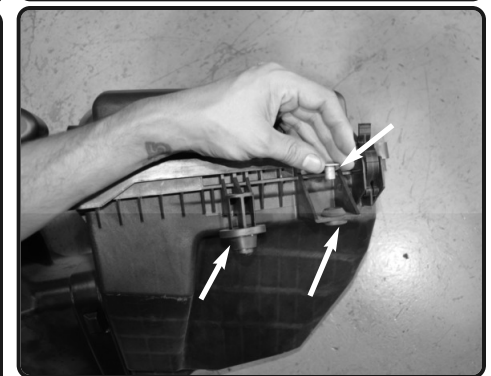

8. Remove the two grommets and spacer washer from the OE air box assembly

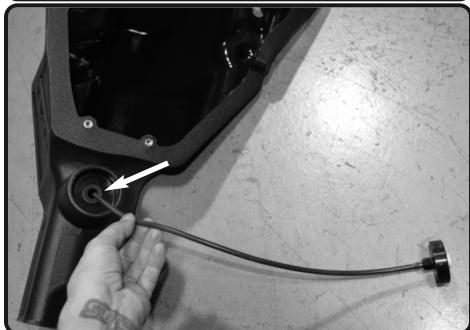

9. Install the grommet into the pod on the lower air box assembly. Then connect the 3mm vacuum line to the Filter Minder. Run the vacuum line through the grommet.



10. Install the smaller grommet and spacer washer from figure 8 into the 1/2" hole on the Injen lower air box assembly.



11. Install the larger grommet from figure 8 and install it into the original hole location on the fender well

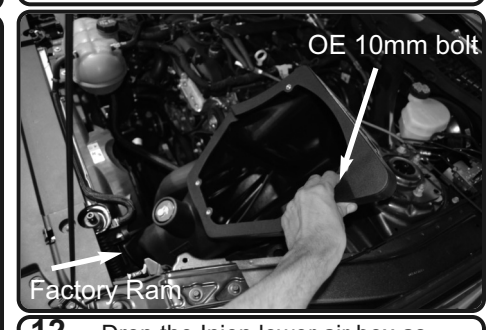

12. Drop the Injen lower air box assembly into the factory air box location. The front ram air should just slide into the Injen air box, Then secure the lower box to the chassis with the original 10mm bolt.



**13.** Place the filter onto the Injen plenum and then secure the clamp



**14.** Connect the 3mm vacuum line from the filter minder to the barbed fitting on top of the filter.



**3.** Place the Injen plenum onto the Injen lower air box assembly and use 4-M6X30 bolts to secure the plenum to the lower air box.

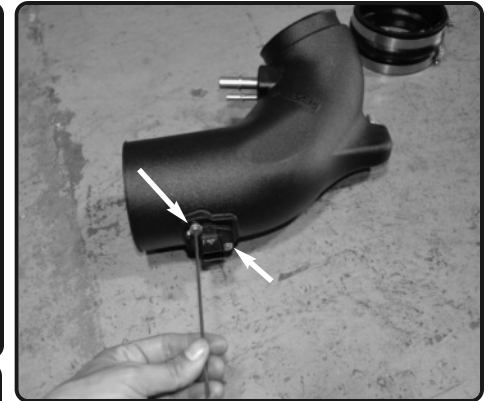

**4.** Use 2-M4 bolts to secure the MAF sensor onto the Injen intake tube

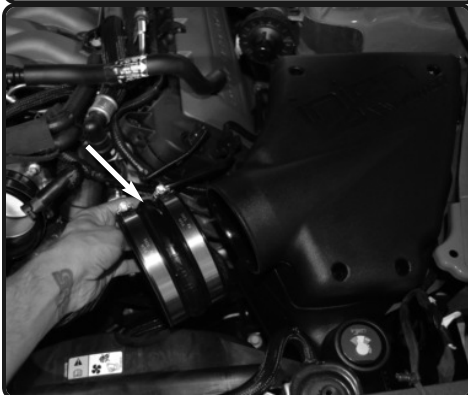

**5.** Place the 4.50" hump hose and 2 #72 clamps onto the Injen plenum.



**6.** Install the 3.50"-4.00" step hose and 1-#64 and #56 clamp onto the throttle body



**7.** Place the Injen intake tube onto the throttle body and Injen intake plenum. Adjust the tube for best fitment and then secure the clamps

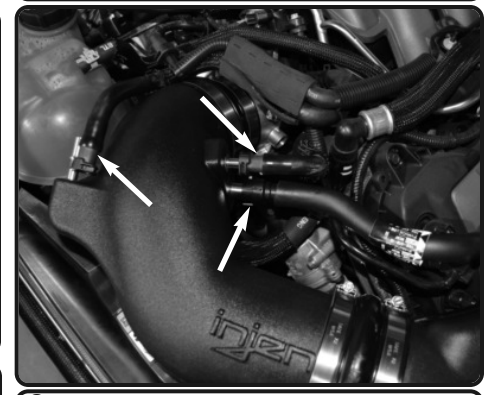

**8.** Re-connect the crank case fitting onto the Injen machined fitting on the intake tube. Make sure it clicks into place.

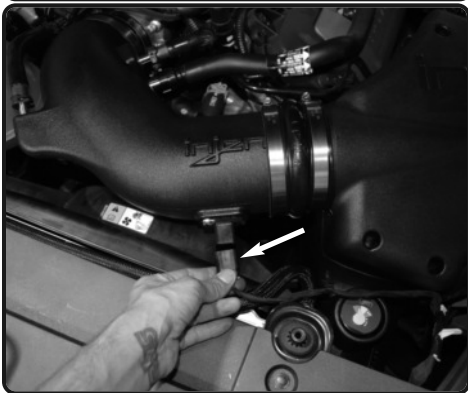

**9.** Re-connect the MAF sensor harness.



Congratulations! You have just completed the installation of this intake system. Periodically, check the alignment of the intake, normal wear and tear can cause nuts and bolts to come loose. **Note: Check clearance and adjust if needed! Failure to check the alignment and adjust the intake can cause damage that will void the warranty. Injen Technology is not responsible for any damages caused by/from improper installation.**

## Test Drive:

1. With the transmission in neutral or park and the parking brake engaged, start the engine. Listen for air leaks or odd noises. If air leaks are detected, secure hoses and connections. For any odd noises, inspect entire system for cause and adjust intake as needed. The Injen intake will function identically to the factory system but will be louder and more powerful.
2. Perform a road test. Listen for odd noises or rattles and fix as necessary.
3. If there are no issues, continue to enjoy your added performance from the Injen performance Intake kit.
4. Injen Technology recommends you periodically check clearance and adjust if needed! Failure to check the alignment and adjust the intake can cause damage that will void the warranty. Injen Technology is not responsible for any damages caused by/from improper installation.

1. Upon completion of the installation, reconnect the negative battery terminal before you start the engine.
  2. Align the entire intake system for the best possible fit. Once the intake has been properly fitted continue to tighten all nuts, bolts and clamps.
  3. Periodically, recheck the alignment of the intake system and make sure there is proper clearance around and along the length of the intake. Failure to follow proper maintenance procedures may cause damage to the intake and will void the warranty.
  4. Start the engine and listen carefully for any odd noises, rattles and/or air leaks prior to taking it for a test drive. If any problems arise go back and check the vacuum lines, hoses and clamps that maybe causing leaks or rattles and correct the problem.
  5. Check the filter for excessive dirt build up. Clean or replace the filter with an original Injen filter (can be bought on-line at "injenonline.com").
- Congratulations! You have just completed the installation of the best intake system sold on the market. Enjoy the added power and performance of your new intake system.