

PAXTON

SUPERCHARGERS



Owner's Installation Guide for the

Paxton Automotive NOVI Supercharger

for the

2011-14 Mustang GT*

**50 State Smog Legal Per CARB EO# D-195-26*

**Paxton Automotive . 1300 Beacon Place . Oxnard CA 93033
888 9-PAXTON • FAX 805 247-0669**

P/N: 4809664 v4.2, 11/13/2017
©2017 Paxton Automotive Corp.
All Rights Reserved, Intl. Corp. Secured

FOREWORD

This manual provides information on the installation, maintenance and service of the Paxton supercharger kit expressly designed for this vehicle. All information, illustrations and specifications contained herein are based on the latest product information available at the time of this publication. Changes to the manual may be made at any time without notice. Contact Paxton Automotive Corp. for any additional information regarding this kit and any of these modifications at 888 9-PAXTON.



Take note of the following before proceeding:

1. Proper installation of this supercharger kit requires general automotive mechanic knowledge and experience. Please browse through each step of this instruction manual prior to beginning the installation to determine if you should refer the job to a professional installer/technician. Please contact your dealer or Paxton Automotive for possible installers in your area.
2. This product was designed for use on stock (un-modified, OEM) vehicles. The PCM (computer), engine, transmission, drive axle ratios and tire O.D. must be stock. If the vehicle or engine has been modified in any way, check with Paxton prior to installation and use of this product.
3. Use only premium grade fuel with a minimum of 91 octane (*R+M/2*).
4. Always listen for any sign of detonation (*knocking/pinging*) and discontinue hard use (*no boost*) until problem is resolved.
5. Paxton Automotive is not responsible for any clutch, transmission, drive-line or engine damage.

Exclusions from Paxton warranty coverage considerations include, but not limited to:

1. Neglect, abuse, lack of maintenance, abnormal operation or improper installation.
2. Continued operation with an impaired vehicle or sub-system.
3. The combined use of Paxton components with other modifications such as, but not limited to, exhaust headers, aftermarket camshafts, nitrous oxide, third party PCM programming or other such changes.

©2016 PAXTON AUTOMOTIVE CORP.

All rights reserved. No part of this publication may be reproduced, transmitted, transcribed, or translated into another language in any form, by any means without written permission of Vortech Engineering, Inc.

TABLE OF CONTENTS

FOREWORD	ii
TABLE OF CONTENTS	iii
IMPORTANT NOTES	iv
TOOL & SUPPLY REQUIREMENTS	v
PARTS LIST	vi
1. BASIC COMPONENT REMOVAL	1
2. MISCELLANEOUS PREPARATION	8
3. ENGINE COOLING SYSTEM MODIFICATION	10
4. SUPERCHARGER ASSEMBLY PREPARATION & INSTALLATION	24
4.1 MOUNTING BRACKET ASSEMBLY DIAGRAM	28
4.2 BELT ROUTING DIAGRAM	29
5. PCV SYSTEM MODIFICATION	30
6. HORN ASSEMBLY RELOCATION	32
7. CHARGE AIR COOLER (CAC) SYSTEM INSTALLATION	34
7A. COOLER CORE INSTALLATION	35
7B. DISCHARGE DUCT INSTALLATION, HOT SIDE	36
7C. DISCHARGE DUCT INSTALLATION, COLD SIDE	37
8. BYPASS VALVE CONNECTION	40
9. FUEL INJECTOR REPLACEMENT	42
10. MISCELLANEOUS REASSEMBLY	44
11. AIR INLET ASSEMBLY INSTALLATION	46
12. BUMPER COVER/FRONT FASCIA MODIFICATION AND REINSTALLATION	48
13. OIL FEED INSTALLATION (OIL-FED UNITS ONLY)	53
14. OIL DRAIN INSTALLATION (OIL-FED UNITS ONLY)	55
15. REFLASH COMPUTER	57
16. FINAL CHECK	58

NOTICE

This product is protected by state common law, copyright and/or patent. All legal rights therein are reserved. The design, layout, dimensions, geometry, and engineering features shown in this product are the exclusive property of Paxton Automotive Corp. This product may not be copied or duplicated in whole or part, abstractly or fundamentally, intentionally or fortuitously, nor shall any design, dimension, or other information be incorporated into any product or apparatus without prior written consent of Paxton Automotive Corp.

2011-2014 Ford Mustang GT

Installation Instructions

Before beginning this installation, please read through this entire instruction booklet and the Street Supercharger System Owner's Manual which includes the Automotive Limited Warranties Program and the Warranty Registration form.

Paxton supercharger systems are performance improving devices. In most cases, increases in torque of 30-35% and horsepower of 35-45% can be expected with the boost levels specified by Paxton Automotive. This product is intended for use on healthy, well maintained engines.

Installation on a worn-out or damaged engine is not recommended and may result in failure of the engine as well as the supercharger. Paxton Automotive is not responsible for engine damage.

Installation on new vehicles will not harm or adversely affect the break-in period so long as factory break-in procedures are followed.

For best performance and continued durability, please take note of the following key points:

1. Use only premium grade fuel 91 octane or higher (R+M/2).
2. The engine must have stock compression ratio.
3. If the engine has been modified in any way, check with Paxton prior to using this product.
4. Always listen for any sign of detonation (pinging) and discontinue hard use (no boost) until problem is resolved.
5. Perform an oil and filter change upon completion of this installation and prior to test driving your vehicle. Thereafter, always use a high grade SF rated engine oil or a high quality synthetic, and change the oil and filter every 3,000 miles or less. **Never attempt to extend the oil change interval beyond 3,000 miles, regardless of oil manufacturer's claims as potential damage to the supercharger may result.**
6. Before beginning installation, replace all spark plugs that are older than 1 year or 20,000 miles with original heat range plugs as specified by the manufacturer and reset timing to factory specifications (follow the procedures indicated within the factory repair manual and/or as indicated on the factory underhood emissions tag). **Do not use**

platinum spark plugs unless they are original equipment. Change spark plugs at least every 25,000 miles.

RECOMMENDED TOOLS FOR INSTALLATION:

1. Factory Repair Manual
2. 3/8" Socket and Drive Set: SAE & Metric
3. 1/2" Socket and Drive Set: SAE & Metric
4. 3/8" NPT Tap and Handle
5. Adjustable Wrench
6. Combination Wrench Set
7. TORX T-20 Driver
8. Oil Filter and Wrench
9. Flat #2 Screwdriver
10. Phillips #2 Screwdriver
11. Stepless Clamp Pliers
12. 3/16" Allen Wrench
13. Utility Knife
14. Hose Cutter
15. Pliers
16. **Oil-Fed Units:**
 - a. 3/8" NPT Tap & Handle
 - b. Center Punch
 - c. 5/8" Tapered Punch
 - d. 8 Quarts Manufacturer-specified Engine Oil
 - e. Oil Filter & Wrench
 - f. Heavy Grease

If your vehicle has in excess of 20,000 miles since its last spark plug change, then you will also need:

16. Spark Plug Socket
17. NEW Spark Plugs



2011-14 Ford Mustang GT

PARTS LIST

Part No. 1001863SL

IMPORTANT: Before beginning installation, verify that all parts are included in the kit. Report any shortages or damaged parts immediately.

PART NUMBER	DESCRIPTION	QTY.	PART NUMBER	DESCRIPTION	QTY.
008569	1 YR S/C STRT INFO PKG ASY PAX 1		7J006-093	6MM WASHER, PLATED	8
009030	S/C LUBE, BOTTLED, PAXT 3-PACK 1		7P250-045	1/4 MALE NPT X 3/8 MALE BARB	1
1016177	S/C ASY, NOVI 2200SL, 2011 MSTG 1		7P312-050	5/16 UNION HOSEMENDER	2
3863515	DECAL, PAXTON COLOR 9" X 3" 1		7P375-050	3/8" HOSE UNION, BRASS	2
4809664	INSTR MAN, PAX, 2011 MSTG GT 1		7P375-098	TEE, 3/8" INCH, PLASTIC	1
4FQ111-013	MNTG BRKT ASY, '11-'14 MSTG 5.0 1		7R002-010	#10 SAE TYPE F SS HOSE CLAMP	2
2A017-875-27	SPACER, .875OD X .404ID X 1.895L	4	7R002-028	#28 SAE TYPE F SS HOSE CLAMP	6
2A017-876-13	SPACER, .875OD X .328ID X 2.730L	2	7R004-001	STEPLESS CLAMP, 15.7-70	4
2A017-876-14	SPACER, .875OD X .328ID X 2.058L	2	7R004-002	STEPLESS CLAMP, 17.0-70	9
2A017-876-15	SPACER, .875OD X .328ID X 2.146L	1	7R004-007	STEPLESS CLAMP, 28.6 X 7MM WIDE	1
2A017-876-16	SPACER, .875OD X .328ID X 1.928L	1	7U030-056	3/8 PCV/VAC RUBBER HOSE	2.5 FT
2A046-031	BELT, 6 RIB X 103.31 EFF. LENGTH	1	7U031-016	5/16" PCV/VAC RUBBER HOSE	1 FT
4FQ010-011	MNTG PLT, OUTER, 2011 MSTG 5.0	1	7U133-050	1.5" X 90° HOSE, LONG LEG	1
4FQ010-021	MNTG PLT, INNER, 2011 MSTG 5.0	1	8N055-080	TANK, RAD OVERFLOW, 05 MUST	1
4FQ017-021	SPCR, .875/1.25OD X .328ID X 1.782L	1	7U038-000	3/4" HEATER HOSE	36"
4FQ017-031	SPCR, .875ODX.404IDX.363L W/.66 PLT	4	4FQ012-030	DISCH ASY, '11-'14 MSTG 5.0 1	
4GF016-161	PULLEY, 3" IDLER, GROOVED, MOD	1	2A017-876-02	SPACER, .875 OD X 1.565 LONG	4
4PCS016-160	PULLEY, IDLER, SRT10 TRUCK	1	4FQ012-040	DISCH TUBE B, 2011 MSTG GT	1
4TX016-150	IDLER, 2.75 DIA, SMOOTH, 7 RIB	2	4FQ012-050	DISCH TUBE C, 2011 MSTG GT	1
7A375-126	3/8-16 X 1.25 HHCS, GR8, PLT	5	4FQ017-011	SPACER, TB, 1.25, 2011 MSTG GT	1
7A375-352	3/8-16 X 3.5" HX HD GR8	5	4FQ112-030	DISCH TUBE A, 2011 MSTG GT, BYPS	1
7C080-064	M8 X 1.25 X 65MM BHCS CL10.9	1	4GE012-030	DISCH TUBE A, 6.2 CAMARO SAT	2
7C080-081	M8 X 1.25 X 80 HXHD CL10.9	1	4PGM012-010	ELBOW, REDUCER, 4X3.5, CAST	1
7C080-101	M8-1.25 X 100 BHCS CL10.9	1	7C040-008	M4-.7X8MM SCHD SS	2
7C080-200	M8-1.25 X 200MM STUD, 35MM THREAD	2	7C060-080	M6 X 1.00 X 80 SHCS CL 12.9	4
7F008-021	NUT, M8 X 1.25, SERRATED FLG	2	7C080-066	M8 X 1.25 X 65 HXHD CL10.9	4
7J312-000	5/16 FLAT WASHER-SAE	3	7F008-021	NUT, M8 X 1.25, SERRATED FLG	4
7K375-040	3/8 AN960 FLAT WASHR PLATED	9	7J006-093	6MM WASHER, PLATED	4
7K375-050	3/8 WASHER, STAINLS, .030THK	1	7J312-875	5/16" WASHER, CUSTOM	8
2A017-875-28	SPACER, .875 OD X 2.730 LONG	1	7P250-187	1/4 NPT FEM X 1/4" BARB	1
4PFQ112-010	AIR INLET ASY, '11-'14 MSTG 5.0 1		7P375-250	3/8"X3/8"X1/4"MALE BARB TEE	1
008359	DECAL, INLET, 2011 MSTG GT PAX	1	7P500-001	1/2" HOSE UNION	4
4FQ012-010	INLET DUCT, 2011 MSTG 5.0 CENT	1	7P500-156	TEE, 1/2" RUN X 1/4 MALE NPT	1
5W001-039	1" HEAT SHRINK TUBING	3 IN	7PS300-275	REDUCER, BLK Ø3.0-Ø2.75	1
5W001-082	SLEEVE, FLEX BRAID, Ø.75" NOM.	.75 FT	7PS300-300	SLEEVE, BLACK, 3.00D X 3.00	3
7J006-093	6MM WASHER, PLATED	2	7PS300-301	BUMP HOSE, 3.00D X 3.00L	1
7P375-039	3/8 NPT X 5/8" BARB 90°	1	7PS350-200	SLEEVE, BLACK 3.50"IDX2.0"LG	1
7P375-106	PCV VALVE, FORD, 3/8" HOSE	2	7PS350-304	SLEEVE, BLK, 3.5" X 3.0"L	1
7P625-004	5/8 TEE #28634	1	7PS400-300	SLEEVE, BLK, 4.0" X 3.0"L	1
7P625-091	5/8 X 5/8 X 90° BARB ELBOW, PLASTIC	1	7PS400-301	REDUCER, HUMP, PROG 3.0 X 4.0	1
7P625-377	5/8" -3/8" RDCR BRB BLK PLASTIC	1	7R002-044	#44 SAE TYPE F SS HOSE CLAMP	1
7PS375-100	SLEEVE, 3.75 X 1.0 3-PLY MATTE BLK	1	7R002-048	#48 SAE TYPE F SS HOSE CLAMP	9
7PS400-225	BUMP SLEEVE, Ø4X2.25, BLACK	1	7R002-052	#52 SAE TYPE F SS HOSE CLAMP	4
7PS400-351	SLEEVE, 4.0 X 3.5 X 2.35L	1	7R002-056	#56 SAE TYPE F SS HOSE CLAMP	5
7R002-056	#56 SAE TYPE F SS HOSE CLAMP	1	7R002-064	#64 SAE TYPE F SS HOSE CLAMP	3
7R002-064	#64 SAE TYPE F SS HOSE CLAMP	3	7R004-687	STPLS CLAMP, 13/16", 1 EAR	8
7R004-002	STEPLESS CLAMP, 17.0-70	2	7S300-003	RUBBER ELBOW 3" MODIFIED	2
7R004-004	STEPLESS CLAMP, 1.0 OD HOSE	6	7S350-120	ELBOW, Ø3.5", 120°, 2.5" C.L.	1
7U030-066	HOSE, 5/8" X 90°, 3" X 3"	1	7S350-220	ASM, FLOW STRAIGHTENER, 3.5 OD	1
7U032-016	3/8" EFI FUEL HSE HI-PSR	0.5 FT	7U012-238	O-RING, 2-238, 3.484ID X .139	1
7U033-000	5/8" PCV HOSE	2 FT	7U030-218	7/32 VAC HOSE, BUNA-N	48 IN
7U100-055	TIE WRAP, 7.5" NYLON	6	7U030-036	1/2" OIL DRAIN HOSE	3 FT
8A004-007-1	BLK OFF PLT, VORT, FORD SLT MAF	1	8A003-071	MAF, 3.8ID, 05 MSTG GT	1
8H040-185	AIR FILTER, 2011 MSTG GT PANEL	1	8H040-175	FILTER, 1.75"ID, RACE BYPS	1
4FQ114-010	CLNG SYS MOD ASY,'11-'14MSTG GT1		5A003-070	ECU REFLASH TL, '11-'14 MSTG GT 1	
4FE014-010	RADIATOR PIPE-STAINLESS	1	8D204-054	RACE BYPASS VALVE-BLACK/SAT 1	
4FQ010-030	BRKT, CLNT RES, 2011 MSTG GT	1	8F160-046	FUEL INJ ASY, '11-'14 MSTG GT 1	
4FQ010-040	BRKT B, CLNT RES, 2011 MSTG GT	1	4FQ017-041	SPCR, FUEL RAIL, EV14, 2011 MSTG GT	4
4FQ010-050	BRKT, FAN MODULE, 2011 MSTG GT	1	8F060-046	FUEL INJ, 47LB EV14	8
4FQ010-060	AIR DAM, FAN SHROUD, 2011 MSTG GT	2	7C060-091	M6 X 1.0 X 90MM SHCS PLT GR12.9	4
4FU014-060	WATER PIPE, Ø1.5 X 90, 07+ MUST GT	1	7J250-001	1/4 WASHER, SAE, PLATED	4
5W001-085	SLEEVE, FLEX BRAID, Ø1.5" NOM	1 FT	8PN101-050	WELDED CAC CORE ASY 1	
7A250-075	1/4-20 X .75 SHCS PLTD	1			
7A250-125	1/4-20 X 1 1/4 SHCS ZINC PLTD	1			
2A017-028	4.3 PLEUM SPACER A, .294 LONG	1			
7F250-021	1/4-20 NYLOCK NUT ZINC PLATED	2			
7A250-051	1/4-20 X .50 HHCS GR5 ZINC PLTD	4			
7C006-038	6-32 X .375 BHCS, 18-8 SS	12			
7F006-001	6-32 HEX NUT, NYLOCK GR5	12			



2011-14 Ford Mustang GT Tuner Kit

PARTS LIST

Part No. 1001863SL-1

IMPORTANT: Before beginning installation, verify that all parts are included in the kit. Report any shortages or damaged parts immediately.

PART NUMBER	DESCRIPTION	QTY.	PART NUMBER	DESCRIPTION	QTY.
008569	1 YR S/C STRT INFO PKG ASY PAX 1		7J006-093	6MM WASHER, PLATED	8
009030	S/C LUBE, BOTTLED, PAXT 3-PACK 1		7P250-045	1/4 MALE NPT X 3/8 MALE BARB	1
1016177	S/C ASY, NOVI 2200SL, 2011 MSTG 1		7P312-050	5/16 UNION HOSEMENDER	2
3863515	DECAL, PAXTON COLOR 9" X 3" 1		7P375-050	3/8" HOSE UNION, BRASS	2
4809664	INSTR MAN, PAX, 2011 MSTG GT 1		7P375-098	TEE, 3/8" INCH, PLASTIC	1
4FQ111-013	MNTG BRKT ASY, '11-'14 MSTG 5.0 1		7R002-010	#10 SAE TYPE F SS HOSE CLAMP	2
2A017-875-27	SPACER, .875OD X .404ID X 1.895L	4	7R002-028	#28 SAE TYPE F SS HOSE CLAMP	6
2A017-876-13	SPACER, .875OD X .328ID X 2.730L	2	7R004-001	STEPLESS CLAMP, 15.7-70	4
2A017-876-14	SPACER, .875OD X .328ID X 2.058L	2	7R004-002	STEPLESS CLAMP, 17.0-70	9
2A017-876-15	SPACER, .875OD X .328ID X 2.146L	1	7R004-007	STEPLESS CLAMP, 28.6 X 7MM WIDE	1
2A017-876-16	SPACER, .875OD X .328ID X 1.928L	1	7U030-056	3/8 PCV/VAC RUBBER HOSE	2.5 FT
2A046-031	BELT, 6 RIB X 103.31 EFF. LENGTH	1	7U031-016	5/16" PCV/VAC RUBBER HOSE	1 FT
4FQ010-011	MNTG PLT, OUTER, 2011 MSTG 5.0	1	7U133-050	1.5" X 90° HOSE, LONG LEG	1
4FQ010-021	MNTG PLT, INNER, 2011 MSTG 5.0	1	8N055-080	TANK, RAD OVERFLOW, 05 MUST	1
4FQ017-021	SPCR, .875/1.25OD X .328ID X 1.782L	1	7U038-000	3/4" HEATER HOSE	36"
4FQ017-031	SPCR, .875ODX.404IDX.363L W/.66 PLT	4	4FQ212-030	DISCH ASY, '11-'14 MSTG 5.0 1	
4GF016-161	PULLEY, 3" IDLER, GROOVED, MOD	1	2A017-876-02	SPACER, .875 OD X 1.565 LONG	4
4PCS016-160	PULLEY, IDLER, SRT10 TRUCK	1	4FQ012-040	DISCH TUBE B, 2011 MSTG GT	1
4TX016-150	IDLER, 2.75 DIA, SMOOTH, 7 RIB	2	4FQ012-050	DISCH TUBE C, 2011 MSTG GT	1
7A375-126	3/8-16 X 1.25 HHCS, GR8, PLT	5	4FQ017-011	SPACER, TB, 1.25, 2011 MSTG GT	1
7A375-352	3/8-16 X 3.5" HX HD GR8	5	4FQ112-030	DISCH TUBE A, 2011 MSTG GT, BYPS	1
7C080-064	M8 X 1.25 X 65MM BHCS CL10.9	1	4GE012-030	DISCH TUBE A, 6.2 CAMARO SAT	2
7C080-081	M8 X 1.25 X 80 HXHD CL10.9	1	4PGM012-010	ELBOW, REDUCER, 4X3.5, CAST	1
7C080-101	M8-1.25 X 100 BHCS CL10.9	1	7C040-008	M4-7X8MM SCHD SS	2
7C080-200	M8-1.25 X 200MM STUD, 35MM THREAD	2	7C060-080	M6 X 1.00 X 80 SHCS CL 12.9	4
7F008-021	NUT, M8 X 1.25, SERRATED FLG	2	7C080-066	M8 X 1.25 X 65 HXHD CL10.9	4
7J312-000	5/16 FLAT WASHER-SAE	3	7F008-021	NUT, M8 X 1.25, SERRATED FLG	4
7K375-040	3/8 AN960 FLAT WASHR PLATED	9	7J006-093	6MM WASHER, PLATED	4
7K375-050	3/8 WASHER, STAINLS, .030THK	1	7J312-875	5/16" WASHER, CUSTOM	8
2A017-875-28	SPACER, .875 OD X 2.730 LONG	1	7P250-187	1/4 NPT FEM X 1/4" BARB	1
4PFQ112-010	AIR INLET ASY, '11-'14 MSTG 5.0 1		7P375-250	3/8"X3/8"X1/4"MALE BARB TEE	1
008359	DECAL, INLET, 2011 MSTG GT PAX	1	7P500-001	1/2" HOSE UNION	4
4FQ012-010	INLET DUCT, 2011 MSTG 5.0 CENT	1	7P500-156	TEE, 1/2" RUN X 1/4 MALE NPT	1
5W001-039	1" HEAT SHRINK TUBING	3 IN	7PS300-275	REDUCER, BLK Ø3.0-Ø2.75	1
5W001-082	SLEEVE, FLEX BRAID, Ø.75" NOM.	.75 FT	7PS300-300	SLEEVE, BLACK, 3.00D X 3.00	3
7J006-093	6MM WASHER, PLATED	2	7PS300-301	BUMP HOSE, 3.00D X 3.00L	1
7P375-039	3/8 NPT X 5/8" BARB 90°	1	7PS350-200	SLEEVE, BLACK 3.50"IDX2.0"LG	1
7P375-106	PCV VALVE, FORD, 3/8" HOSE	2	7PS350-304	SLEEVE, BLK, 3.5" X 3.0"L	1
7P625-004	5/8 TEE #28634	1	7PS400-300	SLEEVE, BLK, 4.0" X 3.0"L	1
7P625-091	5/8 X 5/8 X 90° BARB ELBOW, PLASTIC	1	7PS400-301	REDUCER, HUMP, PROG 3.0 X 4.0	1
7P625-377	5/8" -3/8" RDCR BRB BLK PLASTIC	1	7R002-044	#44 SAE TYPE F SS HOSE CLAMP	1
7PS375-100	SLEEVE, 3.75 X 1.0 3-PLY MATTE BLK	1	7R002-048	#48 SAE TYPE F SS HOSE CLAMP	9
7PS400-225	BUMP SLEEVE, Ø4X2.25, BLACK	1	7R002-052	#52 SAE TYPE F SS HOSE CLAMP	4
7PS400-351	SLEEVE, 4.0 X 3.5 X 2.35L	1	7R002-056	#56 SAE TYPE F SS HOSE CLAMP	5
7R002-056	#56 SAE TYPE F SS HOSE CLAMP	1	7R002-064	#64 SAE TYPE F SS HOSE CLAMP	3
7R002-064	#64 SAE TYPE F SS HOSE CLAMP	3	7R004-687	STPLS CLAMP, 13/16", 1 EAR	8
7R004-002	STEPLESS CLAMP, 17.0-70	2	7S300-003	RUBBER ELBOW 3" MODIFIED	2
7R004-004	STEPLESS CLAMP, 1.0 OD HOSE	6	7S350-120	ELBOW, Ø3.5", 120°, 2.5" C.L.	1
7U030-066	HOSE, 5/8" X 90°, 3" X 3"	1	7S350-220	ASM, FLOW STRAIGHTENER, 3.5 OD	1
7U032-016	3/8" EFI FUEL HSE HI-PSR	0.5 FT	7U012-238	O-RING, 2-238, 3.484ID X .139	1
7U033-000	5/8" PCV HOSE	2 FT	7U030-218	7/32 VAC HOSE, BUNA-N	48 IN
7U100-055	TIE WRAP, 7.5" NYLON	6	7U030-036	1/2" OIL DRAIN HOSE	3 FT
8A004-007-1	BLK OFF PLT, VORT, FORD SLT MAF	1	8A003-071	MAF, 3.8ID, 05 MSTG GT	1
8H040-185	AIR FILTER, 2011 MSTG GT PANEL	1	8H040-175	FILTER, 1.75"ID, RACE BYPS	1
4FQ114-010	CLNG SYS MOD ASY, '11-'14MSTG GT1		8D204-054	RACE BYPASS VALVE-BLACK/SAT 1	
4FE014-010	RADIATOR PIPE-STAINLESS	1	8PN101-050	WELDED CAC CORE ASY 1	
4FQ010-030	BRKT, CLNT RES, 2011 MSTG GT	1			
4FQ010-040	BRKT B, CLNT RES, 2011 MSTG GT	1			
4FQ010-050	BRKT, FAN MODULE, 2011 MSTG GT	1			
4FQ010-060	AIR DAM, FAN SHROUD, 2011 MSTG GT	2			
4FU014-060	WATER PIPE, Ø1.5 X 90, 07+ MUST GT	1			
5W001-085	SLEEVE, FLEX BRAID, Ø1.5" NOM	1 FT			
7A250-075	1/4-20 X .75 SHCS PLTD	1			
7A250-125	1/4-20 X 1 1/4 SHCS ZINC PLTD	1			
2A017-028	4.3 PLEUM SPACER A, .294 LONG	1			
7F250-021	1/4-20 NYLOCK NUT ZINC PLATED	2			
7A250-051	1/4-20 X .50 HHCS GR5 ZINC PLTD	4			
7C006-038	6-32 X .375 BHCS, 18-8 SS	12			
7F006-001	6-32 HEX NUT, NYLOCK GR5	12			

(This page was intentionally left blank)

1. BASIC COMPONENT REMOVAL

NOTE: Retain all fasteners & note the original location of each for future re-use.

- A. Locate the Ambient Air Temperature sensor in the lower grille opening on the driver side of the front bumper cover. Free the plastic clip from its attachment point. (See Fig. 1A)
- B. Remove four (4) 7mm-headed fasteners under the front bumper cover in front of the lip. (See Fig. 1B)
- C. Remove five (5) 7mm-headed fasteners securing the black plastic front undertray. Remove the undertray by moving it back and down and set it aside for later reinstallation. (See Fig. 1C)
- D. Remove two (2) 7mm-headed fasteners from the front edge of each front wheel well (four screws total), which secure the splash shield to the front fascia. (See Fig. 1D)



Fig. 1A: Ambient Air Temp Sensor



Fig. 1B: Front Bumper Cover Lip



Fig. 1D: Splash Shields



Fig. 1C: Front Undertray

1. BASIC COMPONENT REMOVAL, cont'd

- E. Remove eight (8) plastic pins securing the black plastic cover above the grille and radiator. Pop the center section of each pin upward and then the larger part of the pin will loosen. Remove the cover and set aside for later reinstallation. (See Fig. 1E)
- F. **'11-'12 Mustang:** Remove two (2) 8mm-headed fasteners from the body-color tabs on the stop edge of the grille between the headlights and driving lights. (See Fig. 1F)
- G. **'13-'14 Mustang:** Remove the four (4) 8mm-headed fasteners from the top of the bumper. (See Fig. 1G)
- H. Separate the ends of the front fascia from the fenders by pulling straight outward. The fascia will snap free from three (3) clips per side. (See Fig. 1H)
- I. Reach behind the front fascia and unplug the parking lights (1 per side). Also unplug the driving lights.



Fig. 1E: Plastic Cover Pins



Fig. 1F: Top Edge Fasteners ('11-'12 Mustang)



Fig. 1H: Front Fascia Tabs



Fig. 1G: Top Bumper Cover Fasteners ('13-'14 Mustang)

1. BASIC COMPONENT REMOVAL, cont'd

- J. **'11-'12 Mustang:** Lift the front fascia from the locating tabs adjacent to each headlight (by the previously-removed 8mm-headed fastener locations). Pull the fascia forward and away from the car and set it aside for later modification and reinstallation. (See Fig. 1J)
- K. **'13-'14 Mustang:** Slide the front fascia forward, removing it from the bumper cover support. Set the front fascia aside for later reinstallation.
- L. Remove the four (4) plastic pins securing the Styrofoam front bumper cushion and set the pins and cushion aside for later reinstallation. (See Fig. 1K)
- M. **'11-'12 Mustang:** remove the two (2) plastic pins securing the passenger side radiator side shroud. Remove the shroud and set it aside. (See Fig. 1L)
- N. **'11-'12 Mustang:** Remove the plastic pin securing the Ambient Air Temperature sensor harness from the bottom of the driver side radiator side shroud. Remove the two (2) plastic pins securing the shroud itself, snap the shroud free from the airbox snorkel, and set it aside. (See Fig. 1M)



Fig. 1J: Front Fascia Removal



Fig. 1K: Front Bumper Cushion Pins



Fig. 1M: Radiator Side Shroud, Driver ('11-'12 Mustang)



Fig. 1L: Radiator Side Shroud, Passenger ('11-'12 Mustang)

1. BASIC COMPONENT REMOVAL, cont'd

- O. **'13-'14 Mustang:** Remove the two (2) 8mm-headed fasteners from the top of the plastic bumper cover support, between the headlights. (See Fig. 1N)
- P. **'13-'14 Mustang:** Locate the two (2) 8mm-headed fasteners on the bottom of the bumper cover support (near the radiator side shrouds) & remove them. (See Fig. 1O)
- Q. **'13-'14 Mustang:** Remove the 8mm-headed fastener holding the lower mounting block of the bumper cover support to the radiator support (the radiator side shroud is trapped between this block & the radiator support). The head of the fastener is located underneath each headlight. Complete this step for both driver & passenger side. (See Fig. 1P)
- R. If equipped, remove the strut tower brace by removing the four (4) 13mm nuts (2 per side). Pop the engine cover free from its four (4) rubber grommet mounts & set it aside. (See Fig. 1Q)



Fig. 1N: Bumper Cover Support Fasteners ('13-'14 Mustang)

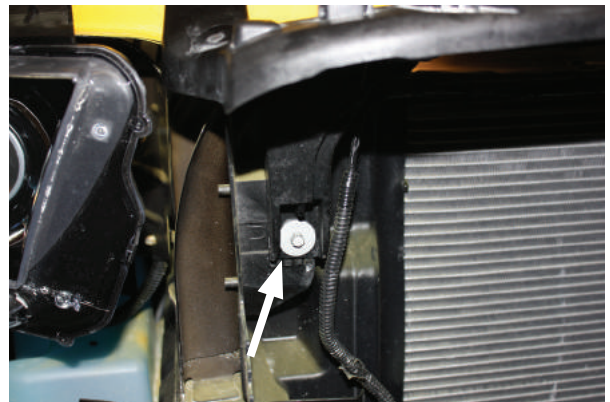

Fig. 1O: Lower Fastener ('13-'14 Mustang. Passenger Side Shown, Drivers Side Similar)



Fig. 1Q: Engine Cover

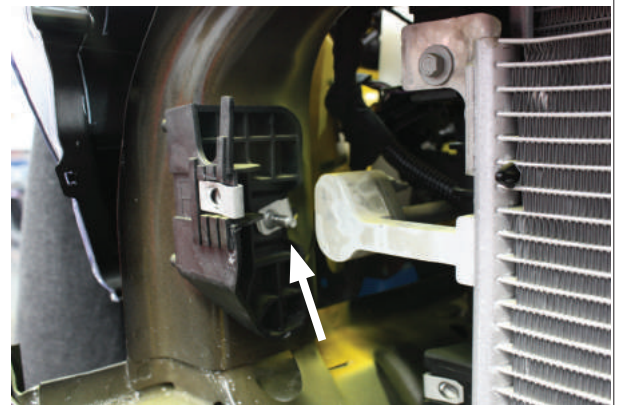

Fig. 1P: Lower Mounting Block. ('13-'14 Mustang. Passenger Side Shown, Drivers Side Similar)

1. BASIC COMPONENT REMOVAL, cont'd

- S. Release the clamp securing the corrugated sound tube to the OEM air inlet duct. Cut the clamp securing the tube to the diaphragm housing at the other end. Disconnect both ends of the tube, snap its mounts free from the airbox and strut tower, and set the tube aside. It will not be reused. (See Figs. 1R-1 & 1R-2)



Fig. 1R-1: Sound Tube, Front

- T. Remove the driver side and passenger side PCV/breather hoses by disconnecting the quick-release fittings at each end. Set them aside for later modification and reinstallation. (See Fig. 1S)

Automatic Transmission Only: Disconnect the small quick-release fitting from the OEM air inlet duct near the sound tube and breather hose connections.

- U. Loosen the hose clamps at each end of the OEM air inlet duct – one at the throttle body and one at the airbox. Remove the duct and set it aside. It will not be reused. (See Fig. 1T)



Fig. 1R-2: Sound Tube, Rear

- V. Remove the 10mm-headed fastener securing the OEM airbox to the driver side inner fender. Remove the airbox and set it aside for later reinstallation.

- W. Remove the 10mm nut securing the OEM cold air snorkel to the fan shroud mounting stud screw and remove the snorkel. Set it aside for later reinstallation.



Fig. 1T: OEM Air Inlet Duct



Fig. 1S: PCV Hoses

1. BASIC COMPONENT REMOVAL, cont'd

- X. Remove the pressure cap from the engine coolant reservoir near the passenger side front of the engine compartment. Locate the engine coolant drain valve at the bottom passenger side corner of the radiator. Open the valve with the hex fitting and drain the coolant into a clean container for later reuse. Drain enough to empty the reservoir and below the level of the upper radiator hose. (See Fig. 1W)
- Y. Unclamp and disconnect the two small hoses from the upper portion of the coolant reservoir. (See Fig. 1X)
- Z. Unclamp and disconnect the larger hose from the bottom of the coolant reservoir. Be prepared to catch any spillage.
- AA. Remove the two (2) 10mm-headed fasteners securing the coolant reservoir. Remove the reservoir and set it aside. It will not be reused. (See Fig. 1Z)
- AB. Release the upper radiator hose clamp connection to the radiator. Release the quick release upper radiator hose connection to the thermostat housing by pulling the spring clip back and sliding the hose fitting off. Remove the upper radiator hose and set it aside for later modification and reuse. (See Fig. AA)

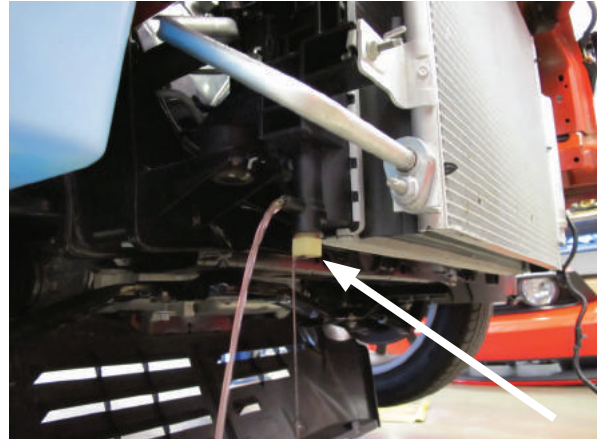

Fig. 1W: Radiator Drain Valve



Fig. 1X: Small Coolant Hoses



Fig. AA: Upper Radiator Hose



Fig. 1Z: Coolant Reservoir

1. BASIC COMPONENT REMOVAL, cont'd

- AC. Unplug the electrical connector from the fan assembly directly under the radiator inlet.
- AD. Remove the two (2) 10mm-headed fasteners securing the radiator fan assembly to the radiator (one per side, near the top of the shroud). Lift the fan assembly upward off of the tab/slot connection on either side and remove. Set it aside for later modification and reinstallation.
- AE. Use a 15mm wrench to rotate the belt tensioner counter-clockwise to release tension from the outer 6-rib accessory drive belt. Remove the belt and set it aside as it will not be reused. (See Fig. 1AD)
- AF. Remove the two (2) TORX T-20 fasteners securing the MAF insert into the OEM airbox. Remove the MAF insert and set aside for later use. (See Fig. 1AE)
- AG. Unplug the electrical connector from the throttle body by sliding the red clip outward and depressing the tab. (See Fig. 1AF)
- AH. Remove the four (4) 10mm-headed screws securing the throttle body to the intake manifold. These fasteners will not be reused. Remove the throttle body and set it aside for later reinstallation, ensuring that the sealing gasket remains in the intake manifold. (See Fig. 1AG)



Fig. 1AD: Belt Tensioner

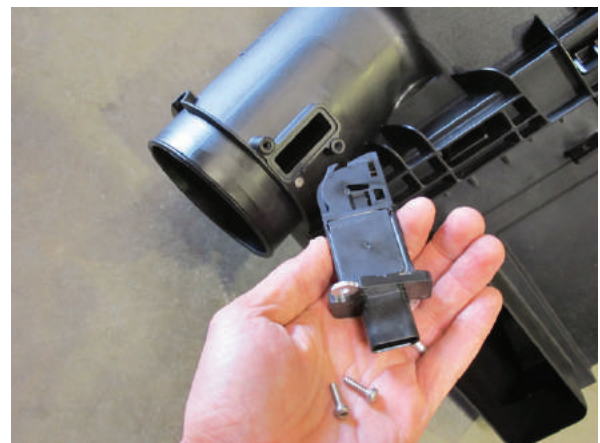

Fig. 1AE: MAF Insert
(shown with OEM airbox removed)



Fig. 1AG: Throttle Body Fasteners



Fig. 1AF: Throttle Body Connector

2. MISCELLANEOUS PREPARATION

- A. Free the large wiring harness from the two (2) mounting locations on the engine front cover forward of the passenger side cylinder head. Use extra care when disengaging the lower clip from the threaded hole in the engine cover as this threaded hole will be used in a later step. If part of the clip breaks off in the threaded hole, carefully extract it without damaging the threads. Route the harness higher up along the passenger side valve cover. (See Fig. 2A)
- B. Carefully cut the OEM plastic hose clamp on the hose running between the "Y" on the thermostat housing and the engine water neck. **Take extra care not to damage the hose.** (See Fig. 2B)
- C. Re-clamp the hose in the previous step with the included #28 worm gear clamp. Orient the clamp so the screw mechanism is toward the driver side, away from the throttle body mounting location. (See Fig. 2C)
- D. Free the large electrical connector near the radiator inlet from its mounting location. Leaving it connected, relocate it forward of the power distribution box/ECU and secure with zip ties. (See Fig. 2D)
- E. Remove the coil covers from the cylinder heads. Remove the ignition coils and spark plugs. Re-gap the spark plugs to .032", re-install and torque to 9 ft-lbs. Reinstall the coils and coil covers.



Fig. 2A: Wiring Harness



Fig. 2B: OEM Plastic Hose Clamp



Fig. 2D: Electrical Connector



Fig. 2C: #28 Hose Clamp Orientation

2. MISCELLANEOUS PREPARATION, cont'd

- F. **Automatic Transmission Only:** Locate the two transmission cooler hoses and hard lines on the passenger side of the engine compartment. (See Fig. 2F)
- G. **Automatic Transmission Only:** Clamp the rubber hoses at either end of the hard line sections to minimize fluid loss. Cut the forward rubber hose segments as close to the hard lines as possible, so the cut ends point directly rearward. (See Fig. 2G)
- H. **Automatic Transmission Only:** Clamp and cut the rubber hoses at the other end of the hard lines. Cut these further back at a location that will allow the extended hoses to travel along the passenger side frame rail.
- I. **Automatic Transmission Only:** Use the included black nylon 1/2" hose unions, 1/2" braided hose, and 13/16" stepless clamps to join the cut OEM rubber hose ends together. Route the hoses along the passenger side frame rail, leaving sufficient slack to allow for engine movement. (See Figs. 2H-1, 2H-2)

NOTE: Take care to connect each hose to the appropriate/matching other end.

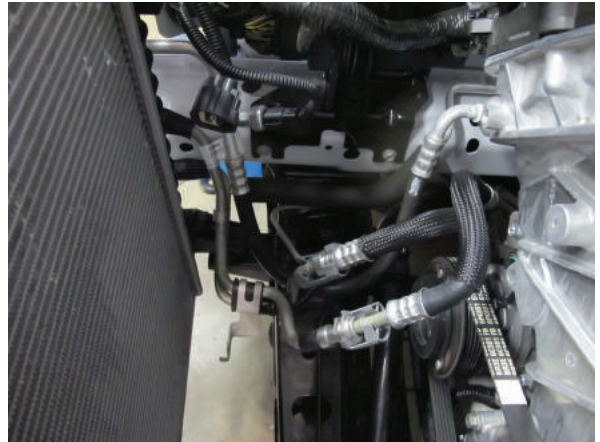

Fig. 2F: OEM A/T Cooler Hoses & Hard Lines



Fig. 2G: Clamping and Cutting A/T Hoses

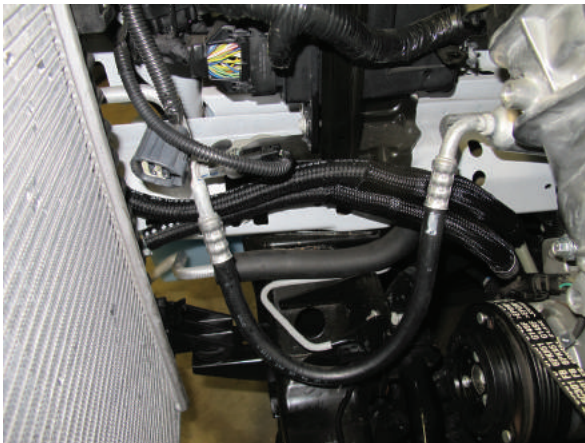

Fig. 2H-2: Completed A/T Hose Modification

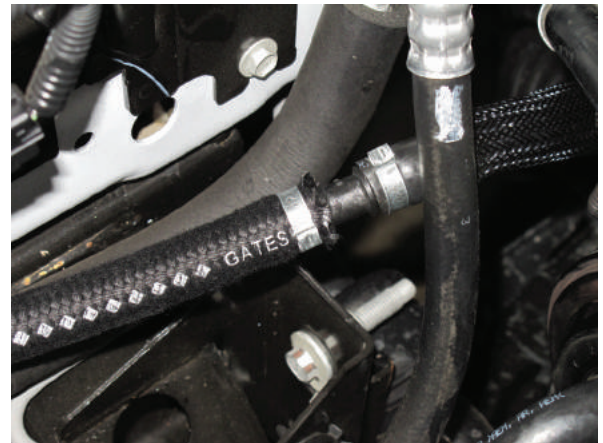

Fig. 2H-1: Joining A/T Hoses

3. ENGINE COOLING SYSTEM MODIFICATION

- A. Locate the previously-removed OEM upper radiator hose. Pull back the braided abrasion sleeve from the quick-release end of the hose, well clear of the 90° hose bend.
- B. Cleanly and squarely cut the upper radiator hose approximately 2" back from the quick-release leg as shown. (See Fig. 3B)
- C. Insert the short end of the included $\text{Ø}1.5'' \times 90^\circ$ steel pipe into the long end of the cut radiator hose and orient as shown, securing with an included #28 worm gear clamp. (See Fig. 3C)
- D. Reattach the long portion of the OEM radiator hose to the radiator same as before, but clocked so the long leg is routed downward along the passenger side of the engine. The exposed leg of the 90° steel pipe should point directly to the driver side. Secure the hose to the radiator with the OEM clamp. (See Fig. 3D)
- E. Cut away the plastic hose clamp on the quick-release end of the cut radiator hose in a similar manner as previously done with the short upper radiator hose, taking care not to damage the hose. (See Fig. 3E)



Fig. 3B: Upper Radiator Hose



Fig. 3C: Radiator Pipe



Fig. 3E: OEM Plastic Hose Clamp

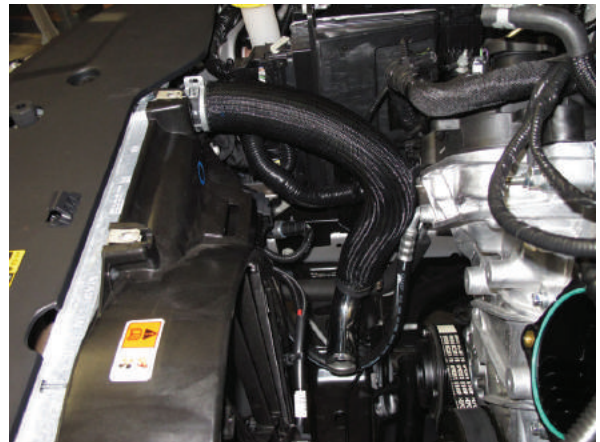

Fig. 3D: Upper Radiator Hose

3. ENGINE COOLING SYSTEM MODIFICATION, cont'd

- F. Carefully remove the cut hose from the quick-release fitting. (See Fig. 3F)
- G. Cut the hose at the approximate middle of the 90° bend, creating a 45° bend. Reinstall it onto the quick-release fitting, orient it as shown, and secure with an included #28 worm gear clamp. Insert the Ø1.5" stainless steel hose union into the open end and secure with an included #28 worm gear clamp. (See Fig. 3G-1) When properly assembled with the quick-release temporarily reconnected, the stainless steel union should point slightly toward the passenger side from straight down. (See Fig. 3G-2)
- H. Locate the included Ø1.5" x 90° rubber hose. Slide the shorter leg over the exposed end of the stainless steel hose union and orient as shown, completely covering the union. When properly assembled with the quick-release temporarily reconnected, the long leg of this hose should point straight toward the passenger side (See Fig. 3H). Slide a segment of the included Ø1.5" black flex braid abrasion sleeve around each straight portion of the hose as shown.



Fig. 3F: Upper Radiator Hose



Fig. 3G-1: Upper Radiator Hose



Fig. 3H: Upper Radiator Hose



Fig. 3G-2: Upper Radiator Hose

3. ENGINE COOLING SYSTEM MODIFICATION, cont'd

- I. Cut approximately 2.75" from the long leg of the Ø1.5" x 90° rubber hose to mate up with the exposed long leg of the 90° steel pipe. Secure with an included #28 worm gear clamp.
- J. Install the new upper radiator hose assembly, ensuring the quick-release mechanism securely snaps into place. Check all connections, and ensure that the hose is routed away from moving parts and sharp edges. (See Fig. 3I)
- K. Remove the two (2) innermost 13mm hex nuts on the top of the passenger side strut tower. These nuts may have already been removed if the car is equipped with a strut tower brace. (See Fig. 3K)
- L. Remove the 10mm hex nut from the stud on the power distribution box directly across from the oil filler cap. (See Fig. 3L) If equipped, first remove the upper 10mm hex nut and OEM ground wire. All of these will be reinstalled in a later step.
- M. Gently bend the A/C service port toward the passenger side between the power distribution box and the strut tower. (See Fig. 3M)

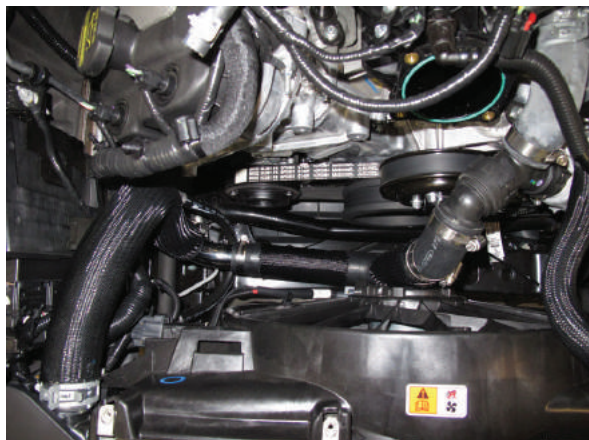

Fig. 3I: Modified Upper Radiator Hose



Fig. 3K: Passenger Side Strut Tower



Fig. 3M: A/C Service Port



Fig. 3L: 10mm Hex Nut

3. ENGINE COOLING SYSTEM MODIFICATION, cont'd

N. In order to provide adequate clearance for installation of the new engine coolant reservoir, minor adjustment to the lower tube of the A/C compressor suction line must be made.

1. Provide proper support to the tube of the A/C suction line. Do this by lightly wedging a piece of wood (a small section of 2x4 works well) between the frame and the aluminum portion of the A/C suction line as shown. The purpose of the temporary wooden support is to direct the bending load into the tube and not the joint where the aluminum tube joins the base mount. Ensure that the wood provides light preload on the middle portion of the aluminum line. See Fig. 3N.

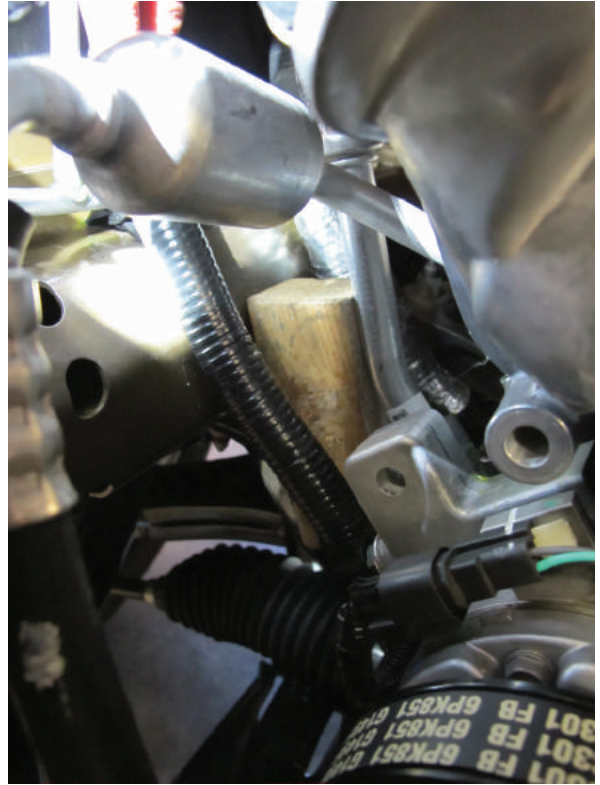

Fig. 3N

3. ENGINE COOLING SYSTEM MODIFICATION, cont'd

2. With the wooden support in place, provide slow and gentle pressure to the top of the metal end of the A/C line using a large screwdriver or pry-bar. Apply enough pressure for the A/C line to move away from the engine approximately 2-3". See Fig. 3P and 3Q to see the before and after difference that is required. Make sure that the joint where the aluminum tube joins the base mount does not absorb the bending load, or the joint may crack. See Fig. 3O.

O. Loosen the forward-most ground wire on the tab on the passenger side strut tower. Reclock it to run as close as possible to the strut tower and retighten. The locking tab will deform in the new position.



Fig. 3O



Fig. 3P: Before (Stock)



Fig. 3Q: After

3. ENGINE COOLING SYSTEM MODIFICATION, cont'd

- P. Loosely assemble the mounting brackets to the replacement coolant reservoir as shown using the included 1/4-20 screws and washers. (See Fig. 3R)
- Q. Install the replacement coolant reservoir brackets onto the two (2) studs on top of the passenger side strut tower and the stud next to the power distribution box. Loosely install the previously-removed OEM 13mm hex nuts and 10mm hex nut. Position the reservoir as close to the strut tower as possible (away from the engine) and tighten all fasteners. Slight adjustment of the A/C line under the reservoir may be necessary. If equipped, reattach the OEM ground wire to the stud and secure with the OEM 10mm hex nut.
- R. Locate the included 3/8" hose and cut a 2" piece. Install the piece onto the hose barb on the replacement coolant reservoir and secure with an included #17 stepless clamp. (See Fig. 3T)
- S. Slide another #17 stepless clamp onto the 2" piece and then insert the black plastic TEE as shown, so one leg points forward and one points to the driver side. Secure with the #17 stepless clamp. (See Fig. 3U)
- T. Locate the small coolant hose running from the driver side front of the engine previously disconnected from the OEM coolant reservoir. Cut the hose in the approximate location shown. (See Fig. 3V)

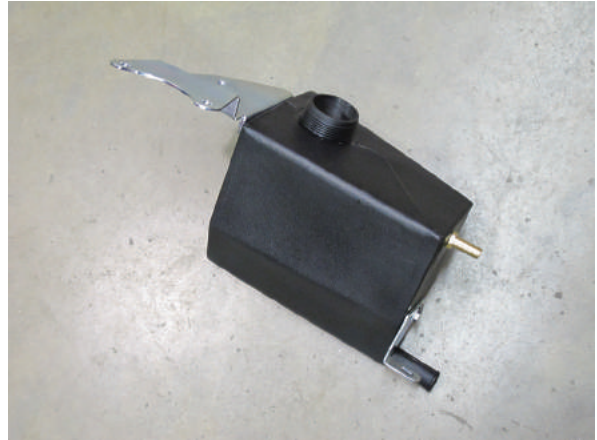

Fig. 3R: Coolant Reservoir



Fig. 3T: Ø3/8" x 2" Hose



Fig. 3V: Small Coolant Hose



Fig. 3U: Black Plastic TEE

3. ENGINE COOLING SYSTEM MODIFICATION, cont'd

- U. Install the cut-off portion of the small coolant hose onto the driver side-facing port of the previously-installed TEE and orient as shown. Secure with the OEM clamp. (See Fig. 3W)
- V. Use the included 5/16" hose, 5/16" barbed hose unions, and #15.7 stepless clamps to extend the upper coolant hose along the top of the engine to the previously cut-off portion connected to the TEE. Route the hose under the large wiring harness as shown and secure away from moving parts and sharp edges. Trim to length and secure with the #15.7 stepless clamps. (See Fig. 3X)
- W. Locate the coolant overflow hose running along the top of the radiator (previously disconnected from the OEM coolant reservoir). Pull back the abrasion sleeve and cut the hose about 1" into the straight section at the driver side end. Use the included 3/8" hose, 3/8" barbed hose union, and #17 stepless clamps to extend the coolant overflow hose along the top of the radiator, under the passenger side upper radiator mount (along the wiring harness) and around to the area of the replacement coolant reservoir. (See Fig. 3Y)
- X. Install the cut-off portion from the previous step onto the forward-facing leg of the TEE installed above and orient as shown. Secure with the OEM clamp. (See Fig. 3Z)



Fig. 3W: Small Coolant Hose



Fig. 3X: 5/16" Coolant Hose, Extended



Fig. 3Z: Coolant Overflow Hose

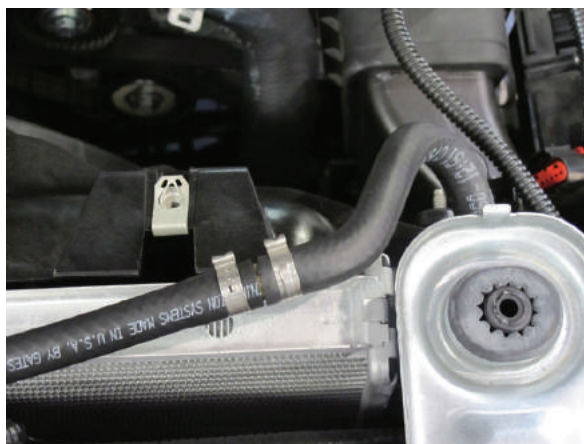

Fig. 3Y: Coolant Overflow Hose Cut & Splice

3. ENGINE COOLING SYSTEM MODIFICATION, cont'd

- Y. Use the included 3/8" hose, 3/8" barbed hose union, and #17 stepless clamps to connect the lengthened coolant overflow hose to the previously cut-off portion connected to the TEE. Trim to length and cover with the OEM abrasion sleeve. (See Fig. 3AA)



Fig. 3AA: Small Coolant Hoses

3. ENGINE COOLING SYSTEM MODIFICATION, cont'd

- Z. On the front, passenger side of the engine compartment, remove the metal OEM harness mounting tab from the vehicle by bending it and breaking it off at the weld joint as shown. The tab will separate from the frame after it has been bent down and back up into its original position. If any sharp metal edges of the tab remain on the frame mount, gently tap the edges down against the frame until they do not protrude. Discard the tab.

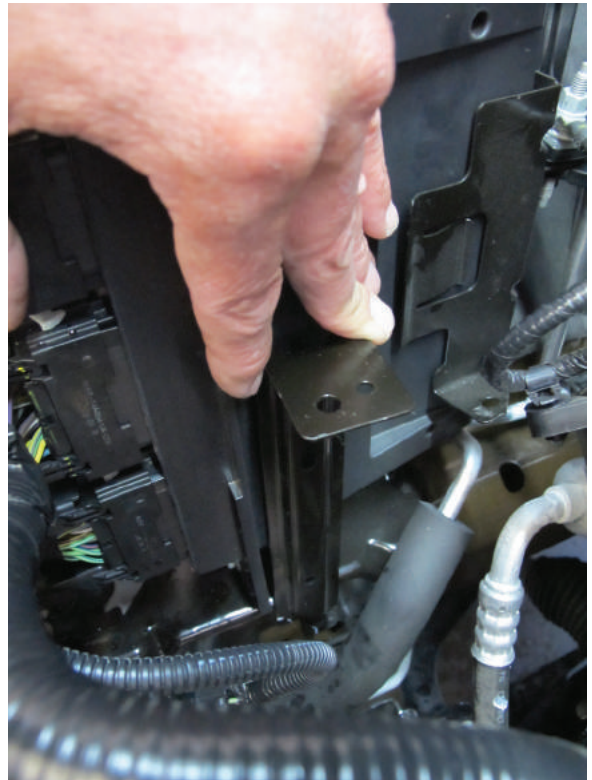

Fig. 3AB-1

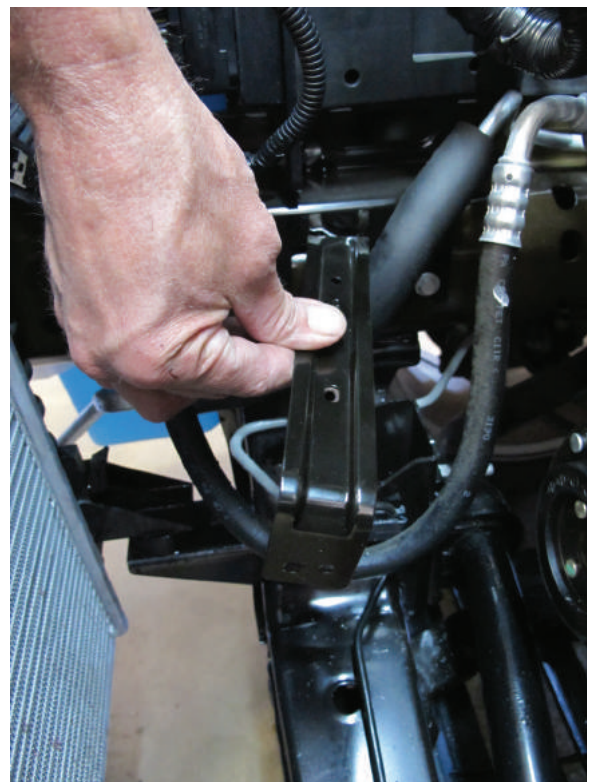

Fig. 3AB-2

3. ENGINE COOLING SYSTEM MODIFICATION, cont'd

- AA. Remove the $\frac{3}{4}$ " rubber OEM coolant hose from the driver side heater tube located on the front of the engine (see Fig. 3AB-3). The OEM hose will not be re-used. Remove the nylon abrasion sleeve from the OEM hose and slide it over the supplied $\frac{3}{4}$ " x 36" length of heater hose. Attach one end of the hose to the nipple on the replacement engine coolant reservoir and secure with the supplied #28.6 stepless clamp (see Fig. 3AB-4). The remaining open end of the $\frac{3}{4}$ " hose will not be connected at this time.

NOTE: This coolant hose will be reconnected in a later step after radiator fan reinstallation.



Fig. 3AB-3

- AB. Move the two spring clamps securing the lower Radiator hose on the drivers side of the vehicle. Remove the hose, place the end that was attached to the Radiator to the outlet on the engine secure the end of the hose that was on the engine to the Radiator and reinstall the spring clamps.

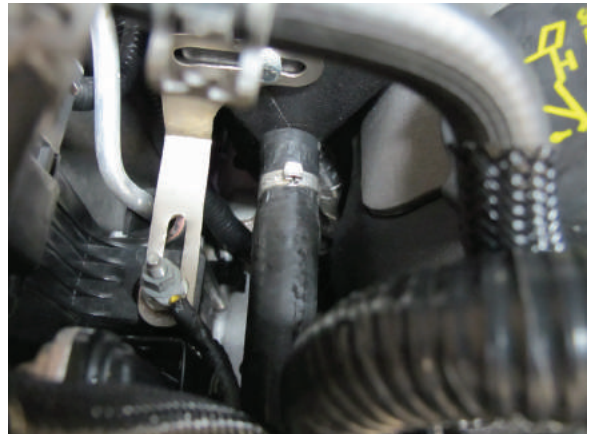

Fig. 3AB-4

3. ENGINE COOLING SYSTEM MODIFICATION, cont'd

- AC. Place the supplied fan shroud air dams into position in the inside bottom corners of the fan shroud as shown. (See Fig. 3AC)
- AD. Trace along the outside (toward the corner) edge of the air dams to mark the cut lines on the fan shroud. (See Fig. 3AD)
- AE. Cut the lower corners of the fan shroud along the cut lines. Trim until the air dams fit with minimal gaps. (See Fig. 3AE)
- AF. Place the air dams into position with the mounting tabs on the *outside* surfaces of the fan shroud and mark the locations of the mounting holes. Drill a 1/8" hole in each location.

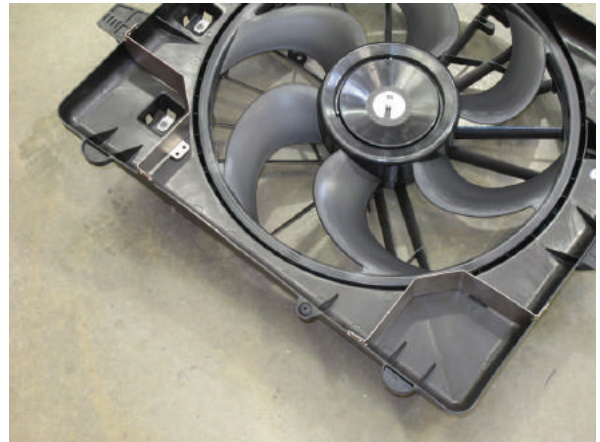

Fig. 3AC: Radiator Fan Shroud Air Dam Placement



Fig. 3AD: Marking Air Dam Cut Lines

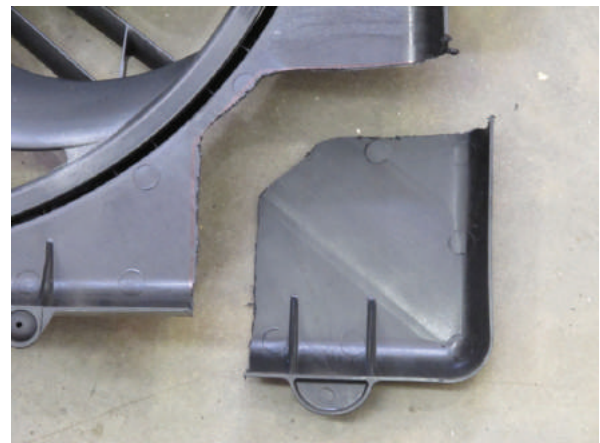

Fig. 3AE: Air Dam Location Cut

3. ENGINE COOLING SYSTEM MODIFICATION, cont'd

- AG. Fasten the air dams to the fan shroud using the included #6-32 button head screws and nylock nuts, with the fastener heads to the outside. (See Fig. 3AF)
- AH. Cut away the boss with the J-nut just above the passenger side air dam. Clearance cut the adjacent ribs. (See Fig. 3AG)
- AI. Depress the two (2) tabs securing the electronic module near the passenger side top corner of the fan shroud. Slide the module to the passenger side and pull it out of the shroud.
- AJ. Trim the fan shroud in the fan module mounting location as shown. (See Fig. 3AI)

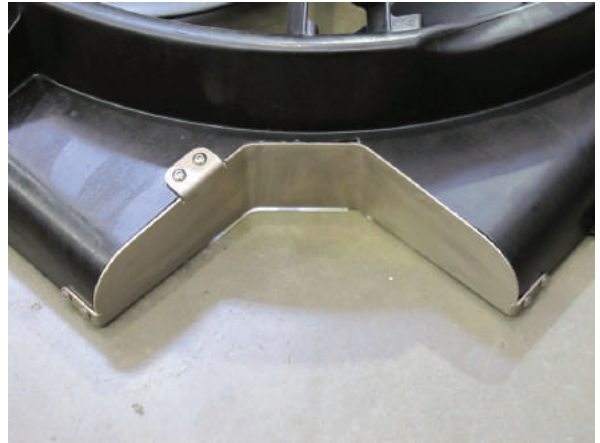

Fig. 3AF: Air Dam Installation

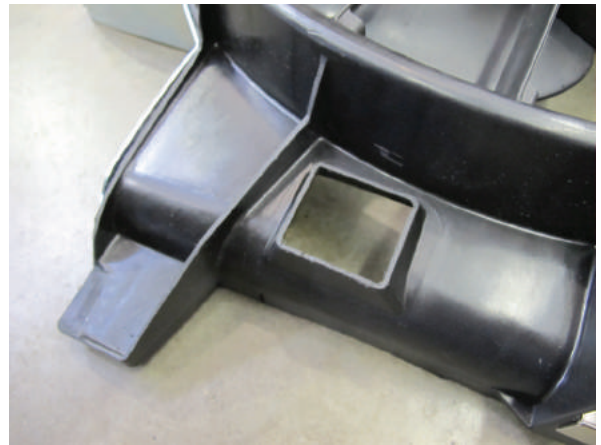

Fig. 3AG

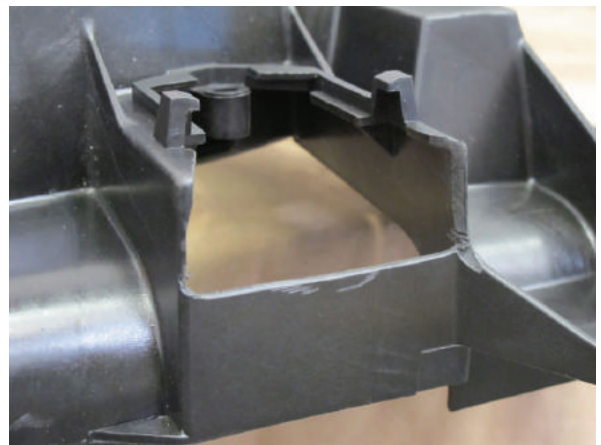

Fig. 3AI: Fan Module Mounting Location Trimming

3. ENGINE COOLING SYSTEM MODIFICATION, cont'd

- AK. Temporarily position the supplied fan module relocation bracket in the location shown and mark the position of the mounting hole. Remove the bracket and drill a 1/4" hole in the marked position. (See Fig. 3AJ)
- AL. Using a 1/4" or 17/64" drill bit, enlarge the hole in the fan shroud boss as shown in Fig. 3AK.
- AM. Insert the fan module down into its approximate mounting location as shown in Fig. 3AL. Slide the relocation bracket into the position shown and then rotate it up into its final position relative to the module.



Fig. 3AJ: Fan Module Bracket Mounting Hole



Fig. 3AK

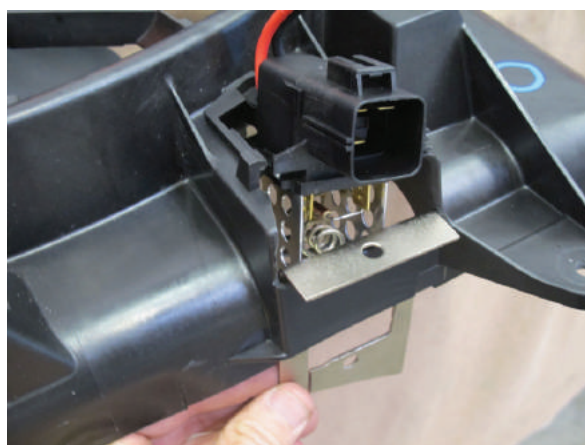

Fig. 3AL: Fan Module Bracket Installation

3. ENGINE COOLING SYSTEM MODIFICATION, cont'd

- AN. Before securing the assembly, sandwich the supplied $\frac{1}{2}$ " OD x .29" long spacer in-between the top of the fan module and the bottom of the fan shroud boss as shown in Figs. 3AM and 3AN.
- AO. Secure the bracket to the module, shroud and spacer using the supplied $\frac{1}{4}$ -20 x .75 screw (side of shroud), $\frac{1}{4}$ -20 x 1.25 screw (top of shroud), nylock nuts and washers.
- AP. Trim top portion of fan shroud as shown in Fig. 3AO.

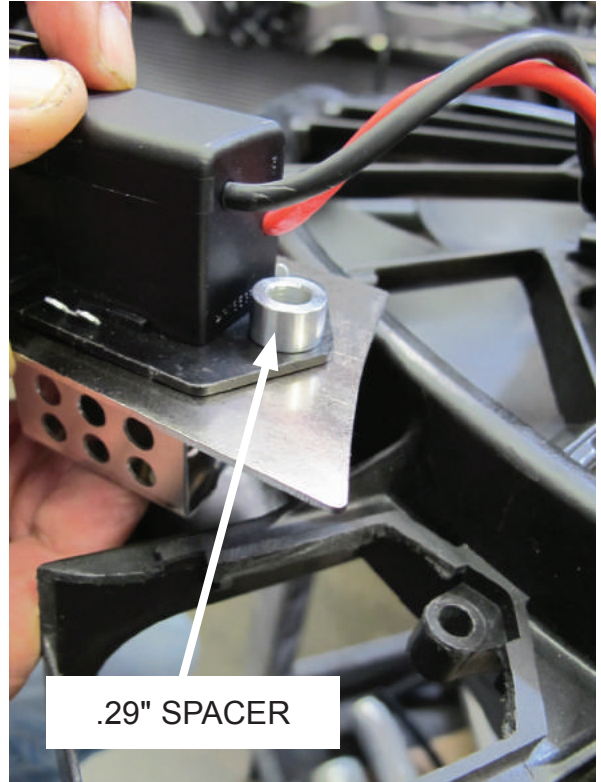

Fig. 3AM

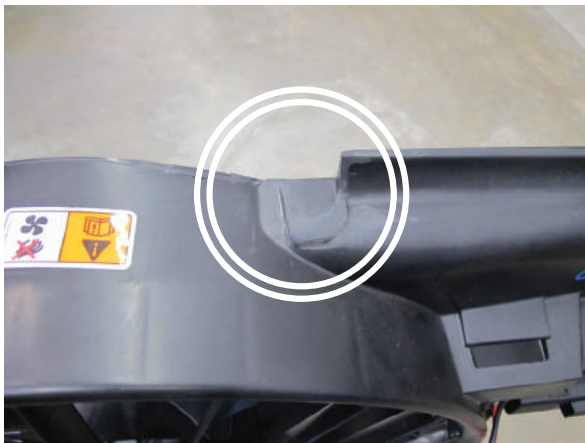

Fig. 3AO

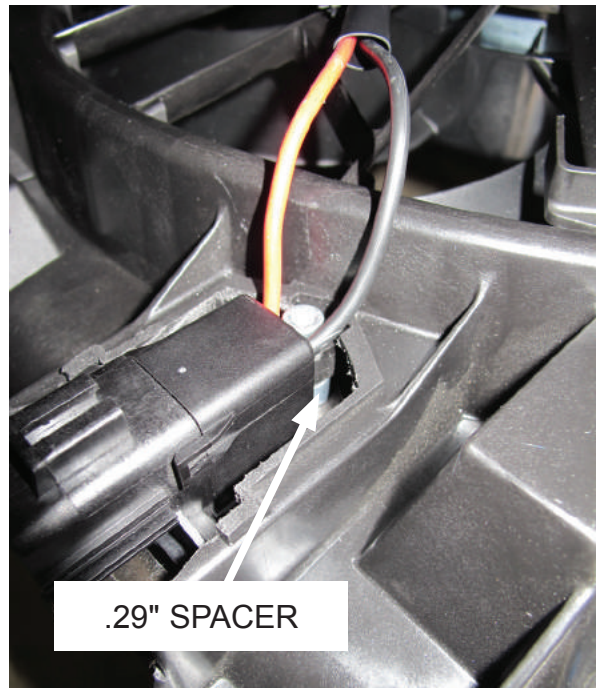

Fig. 3AN

4. SUPERCHARGER ASSEMBLY PREPARATION AND INSTALLATION

NOTES:

1. Many of the fasteners and spacers described in this section are pre-assembled and may either be left that way or used as reference and temporarily disassembled.
2. Refer to Figure 4.1 near the end of this section for the size and position of all spacers.
3. Use blue Loctite (thread locker) on the threads of each screw prior to final tightening of the assembly.

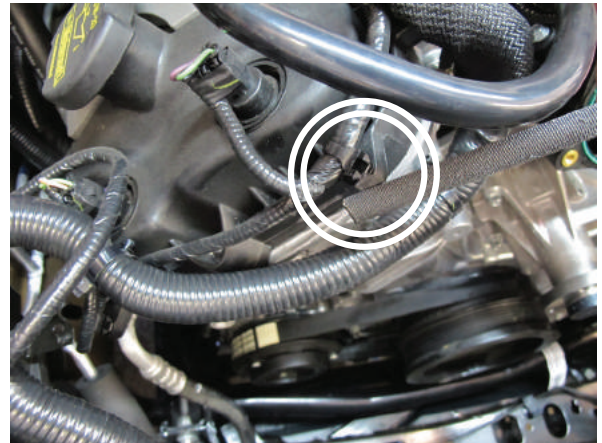

Fig. 4A Modify Tab

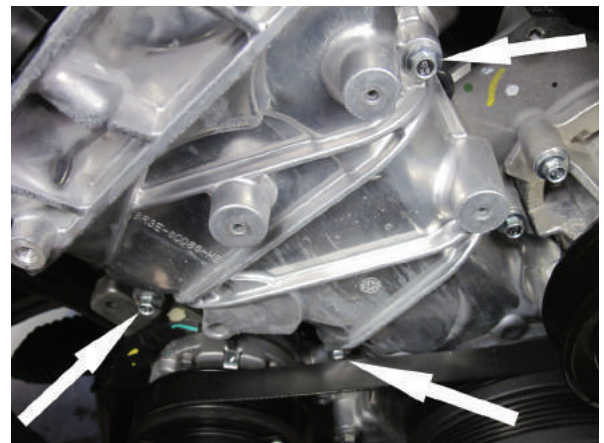

Fig. 4A-2: Engine Cover Screws

- A. Using a coarse file or similar tool, remove approximately 1/8" from the front edge of the passenger side valve cover tab. See Fig. 4A. This will ensure proper supercharger-to-valve cover clearance during installation.
- B. Remove the following three (3) 10mm-headed screws securing the engine front cover on the passenger side: (See Fig. 4A-2)
 - a. The uppermost screw
 - b. The screw just above the A/C compressor
 - c. The screw between the A/C compressor and the crankshaft

4. SUPERCHARGER ASSEMBLY PREPARATION AND INSTALLATION

- C. Inspect the pre-assembled supercharger mounting plate/idler pulley assembly and familiarize yourself with its components and configuration. The new belt should be routed so that the ribbed side engages the ribbed idler pulley and the smooth side rides on the other pulleys. Note the multiple mounting locations of the ribbed idler, used to compensate for different supercharger pulley sizes and belt lengths. All four (4) idler mounting bolts should be left slightly loose during installation to facilitate alignment. (See Fig. 4B and Fig. 4.2 Belt Routing Diagram later in this section)
- D. Thread the two (2) included M8 x 200mm studs into the lower two engine cover fastener holes, in the locations of the previously-removed fasteners (one just above the A/C compressor and one between the A/C compressor and the crankshaft). Use a small amount of blue thread lock on the threads. Leave approximately 6" of stud exposed.
- E. Slide a .875" x 2.058" spacer over the stud above the A/C compressor. **See Fig. 4.1 near the end of this section for this and all other mounting bracket spacer and fastener locations.**
- F. Slide a .875" x 2.146" spacer over the stud between the A/C compressor and the crankshaft.
- G. With the thinner steel plate closer to the engine, begin to slide the mounting bracket assembly over the studs. Place a .875" x 2.730" (.323 I.D.) spacer over each stud, sandwiched between the two mounting plates.
- H. Place a 5/16" flat washer over the open end of each stud and secure with an 8mm flange head nut. Adjust stud exposed length as needed so 1-2 threads protrude beyond the nut. Do not tighten at this time.



Fig. 4B: Belt Routing
(front plate removed for clarity)

4. SUPERCHARGER ASSEMBLY PREPARATION AND INSTALLATION, cont'd

- I. Locate the .875" x 1.928" spacer and M8 x 80mm hex head screw. Place a 5/16" flat washer on the screw and pass it through the outer (3/8" thick) plate and .875" x 1.928" spacer into the threaded boss on the engine cover in the location furthest toward the passenger side. Do not tighten at this time.
- J. Locate the remaining .875" x 2.058" spacer and M8 x 100mm button head screw. Pass the screw through the inner (1/4" thick) plate (with no washer) and .875" x 2.058" spacer into the uppermost engine cover hole from which an OEM screw was previously removed (2nd hole from the top overall). Do not tighten at this time.
- K. **2011 Model Years Only:** Locate the .875"/1.25" x 1.782" tapered spacer and M8 x 65mm button head screw. Pass the screw through the inner plate (with no washer) and the .875"/1.25" x 1.782" spacer (large end against the steel plate) and thread it into the corresponding threaded hole in the engine. Do not tighten at this time.
- L. Tighten the four (4) idler pulley mounting bolts. Ensure that the second-highest bolt has the thin washer (the others have standard-thickness washers).
- M. Confirm that the four (4) screws and two (2) studs securing the supercharger assembly to the engine are properly aligned. Tighten them in progressive steps in an alternating sequence.
- N. **Engine Oil Fed Units Only:** Locate the included length of black braided 1/2" oil drain hose. Remove the shipping cap from the 1/2" barbed oil drain fitting on the bottom of the supercharger and attach the drain hose with the included #8 worm gear clamp.
- O. Place the supercharger into the cradle of the outer mounting plate, aligning the five (5) mounting holes, with the pulley toward the engine and the discharge pointing straight down. Secure the supercharger to the plate with five (5) 3/8-16 x 1.25 hex head screws with washers. Route the braided drain hose (if equipped) directly downward, away from moving parts and sharp edges, and secure.

4. SUPERCHARGER ASSEMBLY PREPARATION AND INSTALLATION, cont'd

- P. Align the 6-rib drive belt according to the diagram shown at the end of this section. The belt routing is almost identical to the OEM routing with the exception of the portion that passes between the water pump pulley and crankshaft pulley to drive the supercharger. Ensure that the belt routes smoothly over the supercharger pulley and all of the new idler pulleys as well as the OEM engine accessories.
- Q. Use a 15mm wrench to rotate the OEM belt tensioner counter-clockwise and install the belt. Depending on pulley size, it may be necessary to adjust the location of the ribbed supercharger idler pulley to achieve proper belt tension. Ensure that the belt wraps smoothly around each of the pulleys and that all ribbed pulleys are properly engaging the belt's ribs.
- R. Locate the supplied 1.25" black anodized aluminum throttle body spacer. Install the included large O-ring into the groove in the spacer -- this O-ring seals against the throttle body, and the smooth side of the spacer seals against the OEM O-ring in the intake manifold. Reinstall the throttle body, **rotated 180° from its original orientation (upside-down)**, using this spacer, the four (4) included M6 x 80mm socket head cap screws, and four (4) included 6mm washers. Ensure that both O-ring seals stay in place. The OEM evaporative emissions tube connecting to the solenoid on the intake manifold just behind the throttle body will have to be slightly bent. (See Fig. 4R)
- S. Carefully snip the strip of tape securing the throttle body electrical harness to the connector housing. Reconnect the connector to the throttle body. (See Fig. 4R)
- T. Route the large wiring harness near the passenger side valve cover, throttle body electrical harness, and any other items away from moving parts and sharp edges and secure.



Fig. 4R: Throttle Body Spacer

FIG. 4.1: MOUNTING BRACKET ASSEMBLY DIAGRAM

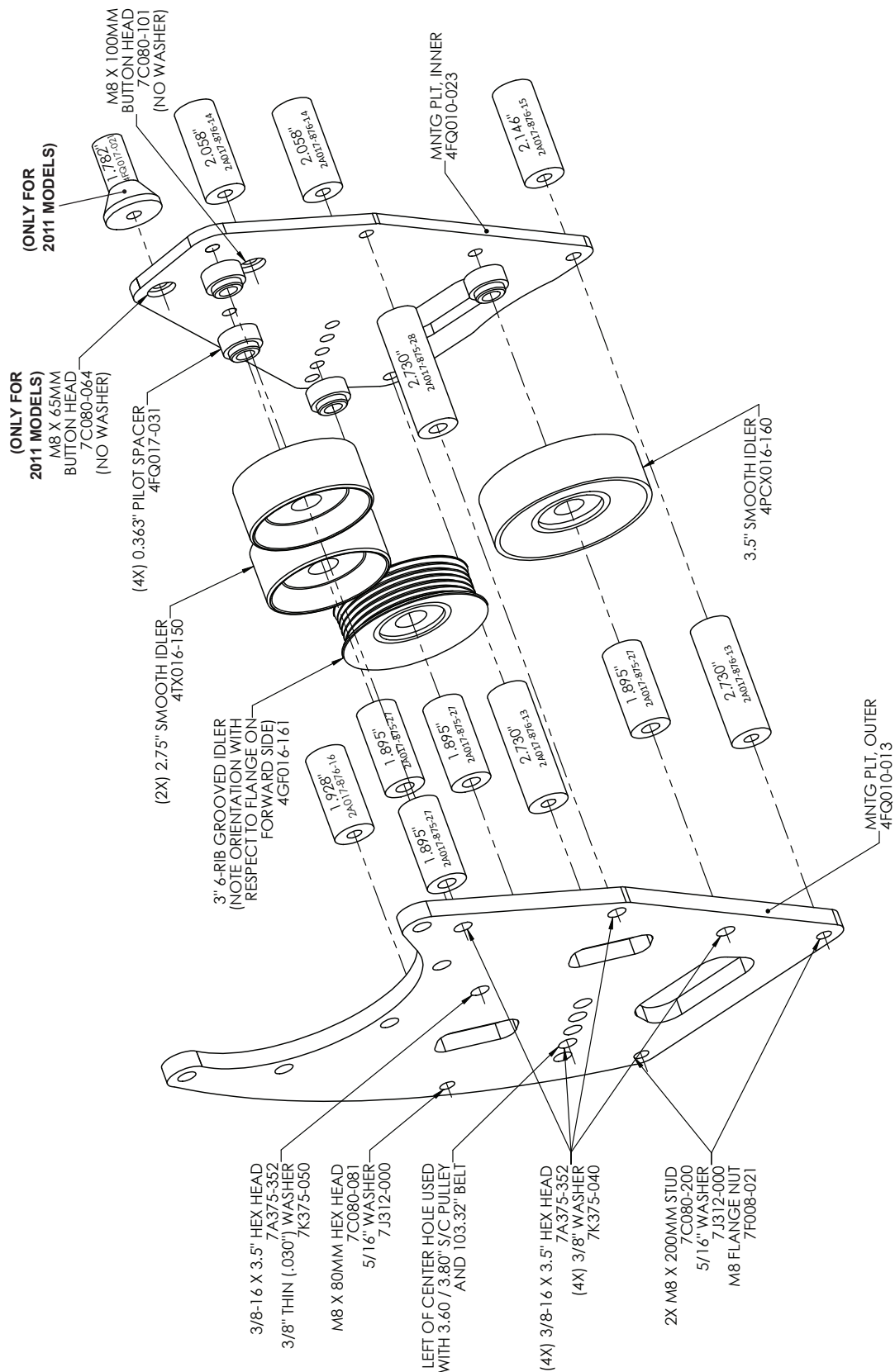

3/8-16 X 3.5" HEX HEAD
7A375-352
3/8" THIN (.030") WASHER
7K375-050
M8 X 80MM HEX HEAD
7C080-081
5/16" WASHER
7J312-000

LEFT OF CENTER HOLE USED WITH 3.60 / 3.80" S/C PULLEY AND 103.32" BELT

(4X) 3/8-16 X 3.5" HEX HEAD
7A375-352
(4X) 3/8" WASHER
7K375-040

2X M8 X 200MM STUD
7C080-200
5/16" WASHER
7J312-000
M8 FLANGE NUT
7F008-021

FIG. 4.2: BELT ROUTING DIAGRAM

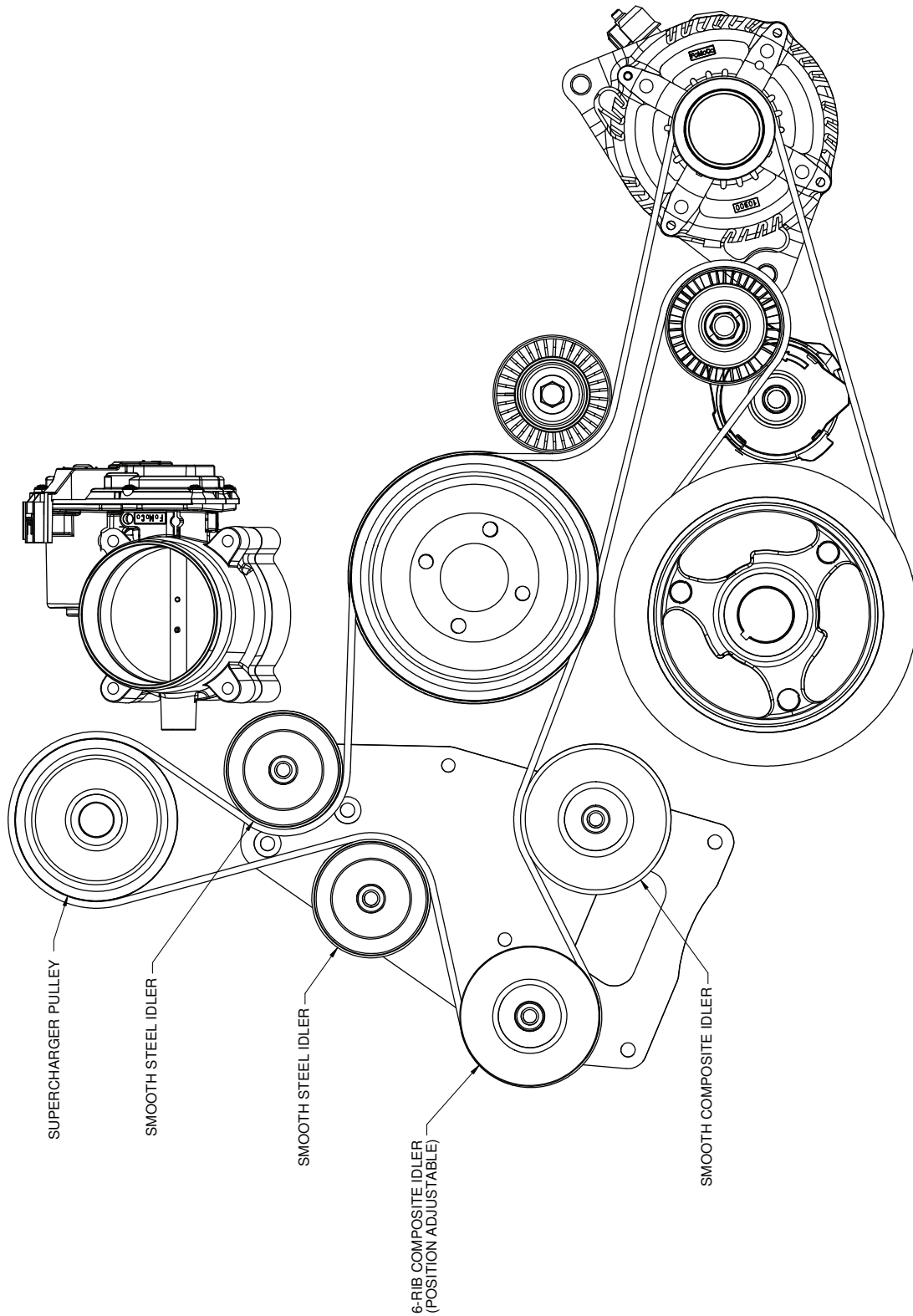

5. PCV/BREATHER SYSTEM MODIFICATION

- A. Locate the previously-removed OEM driver side valve cover breather hose assembly. It has a straight quick-release fitting at one end, a 90° quick-release fitting at the other, and is covered by a foam sleeve. (See Fig. 5A)
- B. Modify and reinstall the driver side PCV hose as follows:
 - a. Pull the foam sleeve back a couple of inches from the end with the 90° fitting.
 - b. Use a razor blade to carefully slit the plastic tube until it can be split away from the barbed fitting inside. Take care not to damage the fitting. (See Fig. 5B)
 - c. Insert the OEM 90° barbed quick-release fitting into one end of the included 5/8" fuel-rated hose and secure with a #25.6 stepless clamp.
 - d. Reconnect the quick-release fitting to its original location on the driver side valve cover.
 - e. Connect the open end of the hose to the fitting on the inlet duct. Trim as necessary and secure with a #25.6 stepless clamp.
- C. Locate the previously-removed passenger side PCV hose assembly. It is U-shaped and has a 90° quick-release fitting at each end. (See Fig. 5C)



Fig. 5A: OEM Driver Side PCV Hose



Fig. 5B: OEM Driver Side PCV Hose



Fig. 5C: OEM Passenger Side PCV Hose

5. PCV SYSTEM MODIFICATION, cont'd

- D. Modify and reinstall the passenger side PCV hose as follows:
- Use a razor blade to carefully slit each end of the plastic tube until it can be split away from the barbed fittings inside. Take care not to damage the fittings. (See Fig. 5D-1)
 - Locate the supplied pre-assembled 90° PCV hose assembly.
 - Slide a #25.6 stepless clamp over each open end of the 90° PCV hose assembly and insert one of the previously-removed OEM 90° quick-release fittings into each open end. Do not secure the clamps at this time.
 - Orient the hoses and fittings as shown, test fit to the engine to confirm end fitting clocking for best fit, and secure the clamps. (See Fig. 5D-3)
 - Install the assembly as shown, routed under the previously-installed small coolant hose, with the end closest to the 90° plastic elbow connecting to the intake manifold. Secure as needed for clearance to the supercharger pulley. (See Fig. 5D-4)



Fig. 5D-1: OEM Passenger Side PCV Hose with fittings removed



Fig. 5D-2



Fig. 5D-4: Modified Passenger Side PCV Hose, Installed



Fig. 5D-3: Modified Passenger Side PCV Hose

6. HORN ASSEMBLY RELOCATION

- A. Locate the horn assembly, located on the outside of the front frame rail near the front of the car. Unplug the electrical connector from the assembly.
- B. Remove the 8mm-headed fastener securing the horn assembly to the car and remove the assembly. (See Fig. 6A)
- C. Remove the 10mm-headed fastener securing each horn to the mounting bracket. Rotate the bracket 180° and reattach it to the horns with the OEM fasteners. (See Fig. 6B)
- D. Reinstall the horn assembly in the original location with the OEM 8mm-headed fastener, but with the mounting bracket rotated approximately 180° from its original orientation. The horns should now still open downward but be mounted higher up than originally. (See Fig. 6C)
- E. Reconnect the electrical connector to the horn assembly.



Fig. 6A: OEM Horn Bracket Orientation

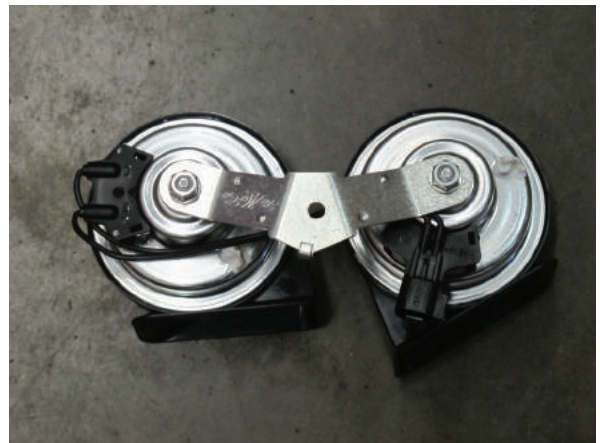

Fig. 6B: Modified Horn Bracket Orientation

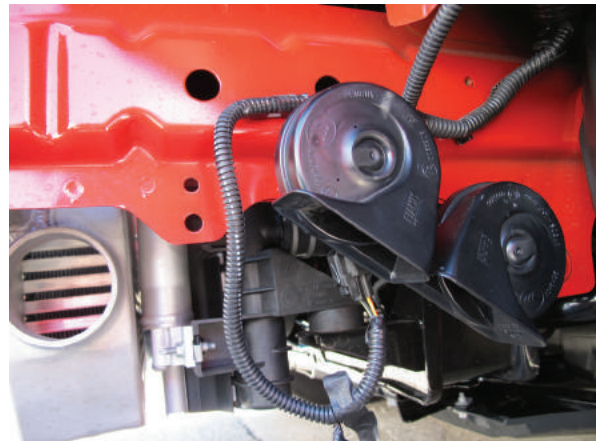

Fig. 6C: New Horn Location

(this page intentionally left blank)

7. CHARGE AIR COOLER (CAC) SYSTEM INSTALLATION



Fig. 7.1: Overview of Charge Air Cooler (CAC) System Configuration

7. CHARGE AIR COOLER (CAC) SYSTEM INSTALLATION, cont'd

NOTE: Leave all duct connections loose until the entire assembly is complete, to allow for adjustments for best fit.

NOTE: Refer to Figures 7.1 and 7.2 at the beginning and end of this section respectively for overviews of the entire CAC system and routing.

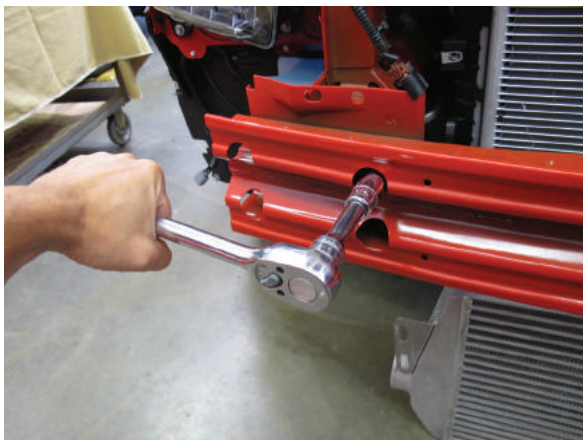

Fig. 7A-1: Inner Bumper Bolts

- A. Cooler Core Installation:
- Remove the inner four (4) 13mm-headed fasteners securing the front bumper to the bumper supports (2 per side). These fasteners will not be reused. (See Fig. 7A-1)
 - Slide the welded Charge Air Cooler (CAC) up into place behind the bumper with the mounting bracket faces flush with the CAC face oriented forward and the inlet/outlet ports at the bottom. Support the CAC on blocks at a height such that the mounting slots line up with the locations of the previously-removed bumper bolts.
 - Secure the CAC to the car with the included M8 x 65mm hex head bolts, the included thick 5/16" washers (one under the head of each bolt), and the 1.565" long spacers. The M8 bolts are installed from the rear of the car forward, in the following sequence: bolt head, thick washer, CAC flange, spacer, car. (See Fig. 7A-2)
 - Install another thick 5/16" spacer onto the exposed end of each new M8 bolt (inside the bumper).
 - Install an M8 serrated flange nut onto the remaining exposed end of each new M8 bolt (inside the bumper, over the thick washer) and tighten. (See Fig. 7A-3)



Fig. 7A-2: CAC Installation Hardware



Fig. 7A-3: CAC Installation Hardware

7. CHARGE AIR COOLER (CAC) SYSTEM INSTALLATION, cont'd

- B. Discharge Duct Installation, Hot Side:
- Install the black silicone $\text{\O}3'' \times \text{\O}2.75''$ reducer ($\text{\O}3''$ straight coupler for 3" discharge superchargers) to the supercharger discharge. Secure with a #44 worm gear clamp (#48 for 3" discharge superchargers).
 - Locate the included bypass valve assembly. Locate the included small cone filter and secure it to the outlet on the bypass valve with the included #28 worm gear clamp. Install the filter with the oval cap oriented the same as the oval bypass outlet.
 - Locate the long $\text{\O}3''$ aluminum tube with the "dog leg" kink and bypass valve flange. Secure the bypass valve assembly to the flange using the supplied gasket and hardware. Orient the assembly with the filter pointing downward along the length of the tube. Insert the shorter leg of the tube into the open end of the supercharger discharge sleeve. Orient it so the bypass valve is rotated to the point that it is nearly touching the supercharger mounting plate and secure with a #48 worm gear clamp. (See Fig. 7B-1)
 - Reinstall the fan assembly, making sure the tab on either side of the shroud engages the corresponding slot. Secure with the OEM 10mm-headed fasteners, with the stud screw on the driver side.
 - Reconnect the fan harness electrical connector to the relocated module.
 - Locate one of the $\text{\O}3'' \times 90^\circ$ aluminum tubes with the tighter bend radius. Connect the longer leg to the bottom of the bypass tube using a $\text{\O}3''$ bump coupler and two #48 worm gear clamps. Orient it to pass through the gap between the radiator drain and the frame. (See Fig. 7B-2)
 - Locate one of the large 90° rubber elbows. Fit the longer leg over the CAC inlet on the passenger side, pointing to the rear as much as possible, passing just outside of the A/C hard line. Secure with a #52 worm gear clamp. (See Fig. 7B-3)
 - Locate the $\text{\O}3'' \times 90^\circ$ aluminum tube with the larger bend radius. Insert one end into the open end of the 90° rubber elbow, and route the other end to the open end of the other 90° tube. Secure to the rubber elbow with a #52 worm gear clamp and to the other 90° tube with a $\text{\O}3'' \times 3''$ long coupler and two #48 worm gear clamps.

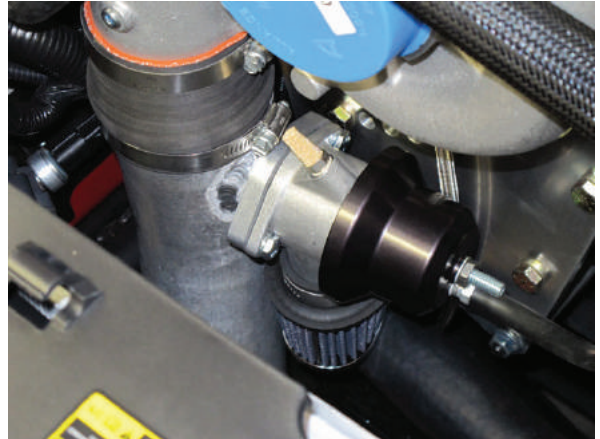

Fig. 7B-1: Bypass Valve Position

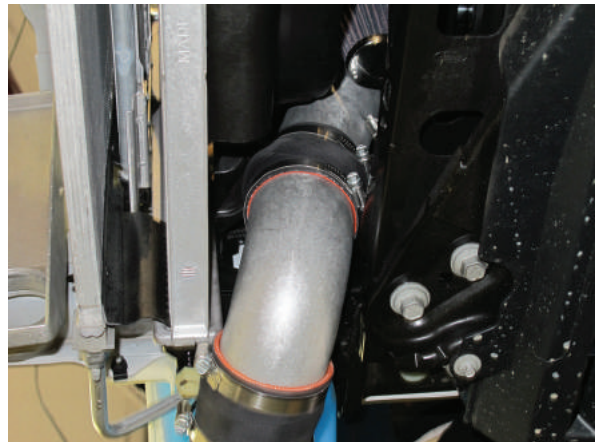

Fig. 7B-2: 90° Tube and Bump Coupler



Fig. 7B-3: Large Rubber Elbow

7. CHARGE AIR COOLER (CAC) SYSTEM INSTALLATION, cont'd

- C. Discharge Duct Installation, Cold Side:
- Locate the remaining large 90° rubber elbow. Fit the shorter leg over the CAC outlet on the driver side, pointing to the rear as much as possible, and secure with a #52 worm gear clamp. (See Fig. 7C-1)
 - Locate the remaining Ø3" x 90° aluminum tube with the tighter bend radius. Insert the shorter leg into the open end of the large 90° rubber elbow and orient it to point to the passenger side of the car, with the open end passing just behind the radiator as close as possible to the car's frame, and secure with a #52 worm gear clamp. (See Fig. 7C-2)
 - Install a Ø3"x3" long black silicone straight coupler on the open end of the Ø3" x 90° aluminum tube and secure with a #48 worm gear clamp.
 - Locate the Ø3" aluminum tube with the multiple bends. Work the "S" bend portion up into the engine compartment and insert the other end (the end with the 90° bend) into the silicone coupler in the previous step. Secure with a #48 worm gear clamp.
 - Locate the previously-removed OEM MAF wire module and install it into the included 3.8" MAF housing using the included M4 fasteners, ensuring the rubber seal is intact and properly seated. (See Fig. 7C-3)
 - Locate the long stepped silicone coupler with the pre-installed honeycomb flow straightener. (See Fig. 7C-4)
 - Insert the end of the MAF housing (nearest the visible resistor and "FoMoCo" logo in the MAF module) into the large opening of the stepped coupler and secure with a #64 worm gear clamp.

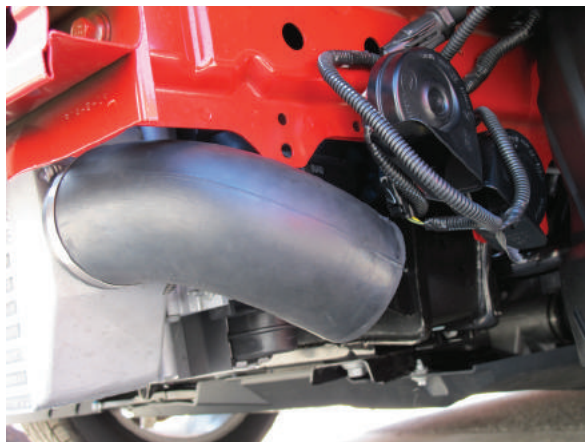

Fig. 7C-1: Large Rubber Elbow



Fig. 7C-2: Tight 90° Tube



Fig. 7C-4: Stepped Coupler with Flow Straightener

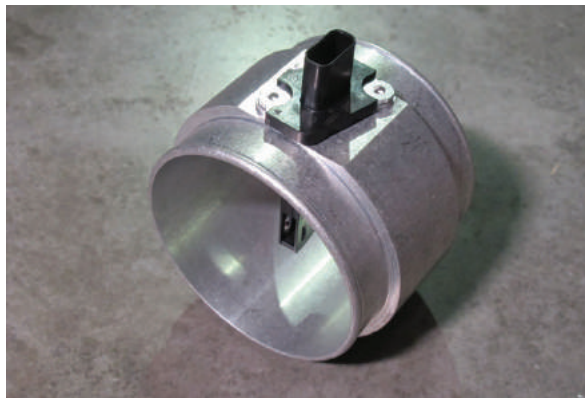

Fig. 7C-3: MAF Housing with OEM Insert

7. CHARGE AIR COOLER (CAC) SYSTEM INSTALLATION, cont'd

NOTE: Take care to install the MAF in the correct orientation relative to the airflow. When properly oriented, the air should move from the resistor (FoMoCo logo) end of the MAF module toward the rounded end of the MAF module.

- C. Discharge Duct Installation, Cold Side (cont'd):
- h. Install a $\text{\O}4$ " silicone coupler onto the open end of the MAF housing and secure with a #64 worm gear clamp.
 - i. Install the small end of the stepped coupler/MAF assembly over the open end of the previously-installed multiple-bend discharge tube. Orient the MAF so the electrical connector points at an angle rearward and to the driver side (near the bend in the lower radiator hose) and secure with a #48 worm gear clamp. (See Fig. 7C-5)
 - j. Reconnect the MAF electrical connector.
 - k. Install the $\text{\O}3.5$ " x 2" long black silicone coupler onto the throttle body and secure with a #56 worm gear clamp.
 - l. Locate the $\text{\O}3.5$ " x 120° cast aluminum elbow. Insert the longer leg into the throttle body coupler, clock to point toward the driver side, and secure with a #56 worm gear clamp. (See Fig. 7C-6)
 - m. Install a $\text{\O}3.5$ " x 3" long silicone coupler onto the open end of the $\text{\O}3.5$ " x 120° cast aluminum elbow and secure with a #56 worm gear clamp.
 - n. Locate the $\text{\O}3.5$ "- $\text{\O}4.0$ " 90° cast reducer elbow and install it between the $\text{\O}3.5$ " x 120° cast aluminum elbow and the MAF housing. Secure it with a #56 worm gear clamp at the elbow end and a #64 worm gear clamp at the MAF end. (See Fig. 7C-7)



Fig. 7C-5: MAF Location (orientation will vary)



Fig. 7C-6: $\text{\O}3.5$ " x 120° Cast Aluminum Elbow



Fig. 7C-7: Cast Elbows, Final Position



Fig. 7.2: Overview of Charge Air Cooler (CAC) System Configuration, Assembled

8. BYPASS VALVE CONNECTION

A. Manual Transmission Only:

- a. Connect the included length of 3/16" vacuum hose to the fitting on the bypass valve. Route the hose away from moving parts and sharp edges along the driver side fuel rail toward the back of the engine.
- b. Locate the OEM 3/8" vacuum hose running to the vacuum brake booster. Remove the split loom from the hose and cut the hose in the approximate location shown behind the driver side fuel rail. (See Fig. 8A-1)
- c. Place the larger ends of the included 3/8" x 3/8" x 1/4" TEE fitting into the cut ends of the vacuum booster hose. Point the smaller fitting forward. (See Fig. 8A-2)
- d. Trim the 7/32" hose from the bypass valve to length and insert it onto the open fitting on the TEE. The hose may be a tight fit. (See Fig. 8A-3)
- e. Reinstall the OEM split loom in its approximate original location. (See Fig. 8A-4)



Fig. 8A-1: Vacuum Hose Cut



Fig. 8A-2: Vacuum TEE



Fig. 8A-4: Vacuum Hose, Complete

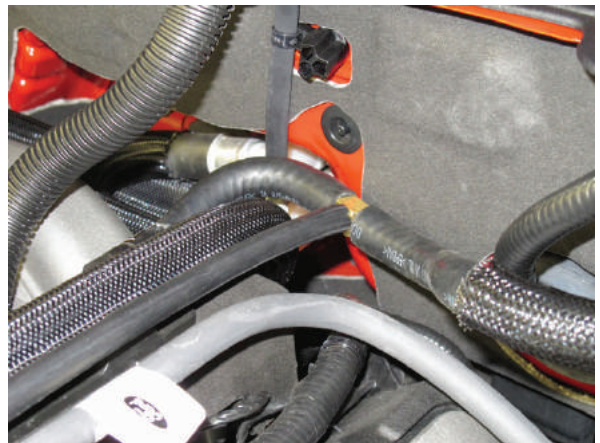

Fig. 8A-3: Bypass Vacuum Hose

8. BYPASS VALVE CONNECTION

B. Automatic Transmission Only:

- a. Connect the included length of 7/32" vacuum hose to the fitting on the bypass valve. Route the hose away from moving parts and sharp edges to the area immediately behind the throttle body.
- b. Locate the OEM 1/2" vacuum hose connected to the intake manifold immediately behind the throttle body to a fitting angled up and toward the driver side. Cut the hose right after the 2nd half of the OEM clamp. (See Fig. 8B-1)
- c. Locate the supplied 1/4" BARB x 1/4" NPTF and 1/2" nylon tee. Apply a small amount of pipe sealant to the threads of the supplied 1/4" NPT hose nipple fitting and install it into the threaded port. (See Fig. 8B-2)
- d. Insert one of the 1/2" barb ends of the TEE fitting into the OEM hose connected to the fitting on the intake manifold and secure with the outer half of the OEM double clamp. Connect the other end of OEM 1/2" hose to the free 1/2" end of the TEE and secure with the OEM clamp.
- e. Trim the 7/32" hose from the bypass valve to length and insert it onto the open fitting on the TEE.

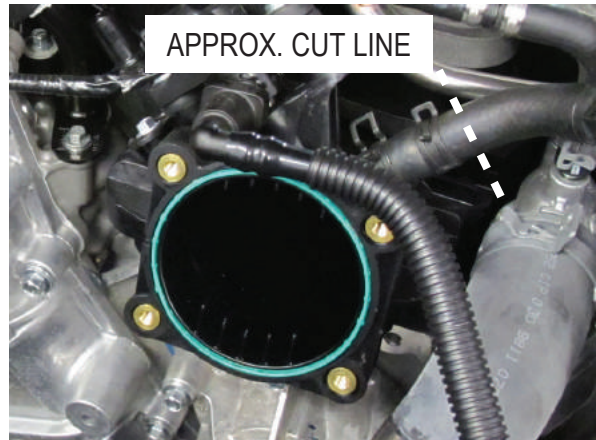

Fig. 8B-1: Cut Vacuum Hose (some components removed for clarity)



Fig. 8B-2: Vacuum TEE

9. FUEL INJECTOR REPLACEMENT

- A. Disconnect the fuel feed line from the fitting near the driver side fuel rail. **CAUTION:** The fuel line may be pressurized. Take care to avoid spray and spills.
- B. Remove the four (4) 10mm hex nuts securing the plastic heater hose guides and set the guides aside for later reinstallation. (See Fig. 9B)
- C. Reposition the vacuum tube assembly mounted under the driver side heater hose guide to facilitate fuel rail removal.
- D. Remove the foam insulation from each fuel rail (2 pieces total).
- E. Unplug each of the eight (8) fuel injector electrical connectors.
- F. Remove the four (4) 10mm-headed screws securing the fuel rails to the intake manifold (2 per side)
- G. Lift the fuel rails (with injectors attached) up and away from the engine, taking care not to spill fuel from the feed fitting. Drain the fuel from the rails.
- H. Locate the four (4) OEM aluminum fuel rail spacers lightly pressed into the intake manifold and pull them free. (See Fig. 9H)
- I. Locate the supplied shorter fuel rail spacers and insert them into the intake manifold in place of the OEM spacers.
- J. Note the orientation of the OEM injectors in the fuel rails. Disengage the retaining clips and remove the OEM injectors.
- K. Install the supplied high-flow injectors into the fuel rails in the same orientation as the OEM injectors and secure in the original fashion with the OEM retaining clips. (See Fig. 9K)



Fig. 9B: Hose Guide Removal

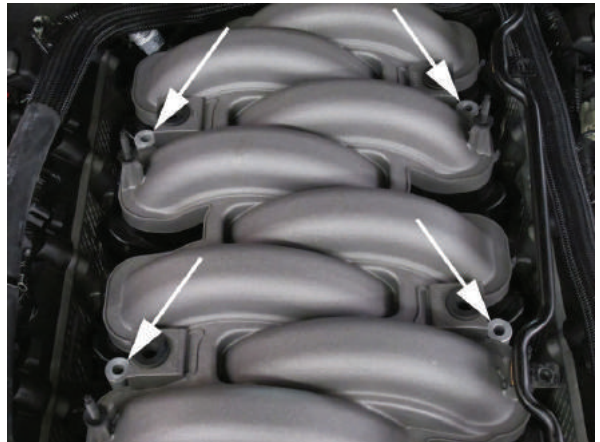

Fig. 9H: Aluminum Fuel Rail Spacers



Fig. 9K: Fuel Rail / Injector Assembly Detail

9. FUEL INJECTOR REPLACEMENT, cont'd

- L. Install the rail/injector assembly into the intake manifold.
- M. Secure the fuel rails with the four (4) included M10 x 90mm socket head cap screws with washers. (See Fig. 9M)
- N. Connect the fuel injector electrical connectors to each of the eight (8) injectors.
- O. Place the foam insulation back over each fuel rail.
- P. Place the vacuum tube assembly back into position on the studs near the driver side fuel rail.
- Q. Reinstall the plastic heater hose guides and secure with the OEM 10mm hex nuts. Route the heater hoses over them in the OEM fashion.
- R. Reconnect the fuel feed line to the fitting on the fuel rail assembly. Make sure it is securely connected in the OEM fashion.



Fig. 9M: Re-securing Fuel Rails

10. MISCELLANEOUS REASSEMBLY

- A. Reconnect the upper radiator hose quick release to the “Y” fitting on the thermostat housing. Confirm all hose connections are secure.
- B. Attach the open end of the new $\frac{3}{4}$ ” coolant hose (with OEM abrasion sleeve attached) previously connected to the replacement engine coolant reservoir, to the driver side heater tube located on the front of the engine. (See Figs. 10B-1, 10B-2)
- C. Refill the engine cooling system via the replacement coolant reservoir with the previously-drained coolant. Filter if needed, ensuring no contaminants enter the cooling system. The coolant reservoir should be approximately 1/2 full. Do not overfill. Close the reservoir with the OEM cap from the OEM coolant reservoir.

NOTE: Periodically check the coolant level once the car is running and the cooling system purges.



Fig. 10B-1: $\text{Ø}\frac{3}{4}$ ” Coolant Hose

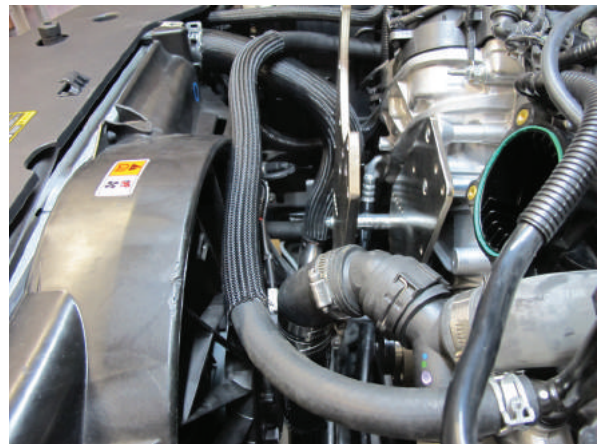

Fig. 10B-2: $\text{Ø}\frac{3}{4}$ ” Coolant Hose

10. MISCELLANEOUS REASSEMBLY, cont'd

- D. Trim the passenger side front corner of the engine cover as shown. Start with a small cut and check fitment, only trimming away as much as necessary for clearance. (See Fig. 10D-1)
- E. Locate the Ambient Air Temperature sensor previously removed from the front bumper cover. It is located near the horn assembly. Secure it to the wiring harness near the horn assembly, using the supplied zip ties, where it will receive fresh air flow.
- F. Reinstall the black plastic cover above the grille and radiator. Secure with the four (4) rearmost plastic pins.



Fig. 10D-1: Engine Cover Cut Detail

11. AIR INLET ASSEMBLY INSTALLATION

- A. Confirm that the 3/8 NPT port on the bottom of the inlet duct is drilled through. If not, drill through with a 1/2" bit, taking care to remove all burrs. Install the included 3/8 NPT x 5/8 90° hose barb fitting into the black roto-molded inlet duct as shown. (See Fig. 11A)
- B. Connect the inlet duct to the supercharger inlet with the Ø4" x Ø3.5" silicone reducer (straight Ø4" for 4" inlet superchargers) and secure with a #64 and a #56 worm gear clamp (2 x #64 for 4" inlet superchargers). (See Fig. 11B)
- C. Connect the new valve cover breather hose previously connected to the driver side valve cover to the 3/8 NPT 90° hose barb previously threaded into the inlet. Trim the hose to length as needed.
- D. **Automatic Transmission Only:** Cut the driver side breather hose from the previous step approximately 1"-2" past the air inlet opening. Insert the 5/8 hose barb TEE fitting so that the open leg points in the general direction of the throttle body.
- E. **Automatic Transmission Only:** Locate the OEM 3/8" vacuum hose with the quick-release fitting previously disconnected from the OEM air inlet. Cut the hose past the first 90° bend from the quick-release fitting. The fitting and section of hose connected to it will not be reused. (See Fig. 11E)



Fig. 11A: Air Inlet 3/8 NPT 90° Hose Barb Fitting



Fig. 11B: Air Inlet to Supercharger Connection



Fig. 11E: Auto Trans Vacuum Hose Cut

11. AIR INLET ASSEMBLY INSTALLATION, cont'd

- F. **Automatic Transmission Only:** Locate the supplied grey PCV valve (same as the one used for the passenger side PCV hose). Insert the large end into a section of the supplied 5/8" PCV hose. Insert the small end into the 3/8" vacuum hose from which the quick-release fitting was previously cut. Cut the open end of the new 5/8" PCV hose to length and connect it to the open leg of the 5/8 hose barb TEE fitting in the new driver side PCV hose. (See Fig. 11F)
- G. Remove the lid from the OEM airbox and replace the OEM paper filter element with the included high-flow panel filter element. Replace the lid.
- H. Reinstall the OEM airbox snorkel and airbox assembly, securing the snorkel to the fan shroud stud screw with the OEM 10mm nut and the airbox to the inner fender with the OEM 10mm-headed fastener.
- I. Connect the inlet duct to the OEM airbox with the Ø4" bump hose. Use the included Ø3.75" x 1" long silicone ring to adapt the airbox fitting up to Ø4" to fit inside the bump hose. Secure with two #64 worm gear clamps. (See Fig. 11I)
- J. Seal the OEM MAF element port on the airbox with the black anodized MAF port cover and secure with the OEM MAF retaining screws and the included washers. (See Fig. 11I)
- K. The completed assembly is shown in Figure 11K.



Fig. 11F: (Automatic Transmission Only) Driver Side PCV Hose Modification (Hose Segments Cut for Illustration Only)



Fig. 11I: Air Inlet to Airbox Connection; MAF Port Cover



Fig. 11K: Complete Air Inlet Assembly

12. BUMPER COVER/FRONT FASCIA MODIFICATION AND REINSTALLATION

- A. Trim the OEM radiator shroud panels as shown in Figs. 12A-1 through 12A-4. Carefully cut as necessary for best fit. Reinstall into their original positions using the OEM fasteners.

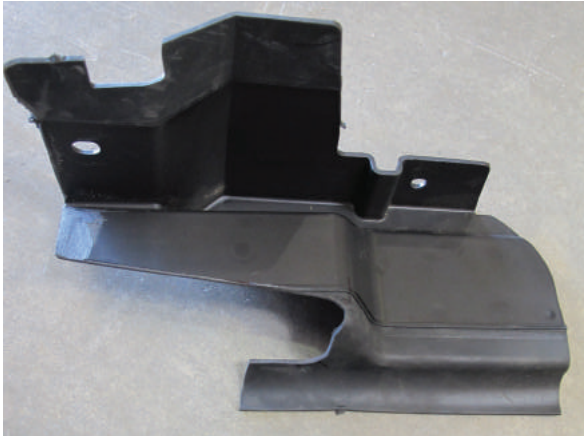

Fig. 12A-1: Modified Passenger's Side Shroud



Fig. 12A-2: Modified Driver's Side Shroud



Fig. 12A-3: Passenger's Side



Fig. 12A-4: Driver's Side

- B. Reinstall the styrofoam front bumper cushion in its original location using the OEM plastic push pins.
- C. Confirm that the top of the CAC core is even with or below the top surface of the bumper cushion and that it is centered left to right. Adjust CAC position as needed by loosening the mounting fasteners.

12. BUMPER COVER/FRONT FASCIA MODIFICATION AND REINSTALLATION, cont'd

NOTE: 11-'12 Mustang front bumper cover must be trimmed to provide clearance for the Charge Air Cooler. Proceed to Step D.

'13-'14 Mustang front bumper cover does not require trimming. Skip to Step E.

NOTE: Discharge tubes will not clear the fog lights on California Special models. Fog lights will need to be removed or custom discharge tubing will need to be obtained.

D. **'11-'12 Mustang:** Trim the bumper cover from the inside as shown. Cut in small increments, periodically test fitting the bumper cover to the car to avoid excess material removal. (See Fig. 12D-1)

- a. Trim away the portion of the driver side lower faux vent as shown, without breaking through the louvered panel, to provide clearance to the 90° rubber elbow. (See Fig. 12D-2)
- b. Trim away the portion of the passenger side lower faux vent as shown, without breaking through the louvered panel, to provide clearance to the 90° rubber elbow. (See Fig. 12D-3)



Fig. 12D-1: Bumper Cover



Fig. 12D-2: Bumper Cover, Driver Side



Fig. 12D-3: Bumper Cover, Passenger Side

12. BUMPER COVER/FRONT FASCIA MODIFICATION AND REINSTALLATION, cont'd

- c. Cut away the center lower grille opening as shown, including the two (2) vertical pillars. (See Fig. 12D-4)
 - d. From the inside of the bumper opening, measure 1.5" inwards from the face of the vertical pillar & make a mark. Do this for both sides of the bumper opening. (See Fig. 12D-5)
 - e. From the centerline of the bumper opening, measure 3.5" inwards from the beveled edge & make a mark. (See Fig. 12D-6)
- Using a marker, connect the 3 reference marks & cut away that section of the bumper to provide clearance for the CAC. Test fit the bumper to verify clearance. If more clearance is necessary, continue to trim as required. (See Fig. 12D-7) Cut away the center lower grille opening as shown, including the two (2) vertical pillars. (See Fig. 12D-4)
- f. From the inside of the bumper opening, measure 1.5" inwards from the face of the vertical pillar & make a mark. Do this for both sides of the bumper opening. (See Fig. 12D-5)
 - g. From the centerline of the bumper opening, measure 3.5" inwards from the beveled edge & make a mark. (See Fig. 12D-6)
 - h. Using a marker, connect the 3 reference marks & cut away that section of the bumper to provide clearance for the CAC. Test fit the bumper to verify clearance. If more clearance is necessary, continue to trim as required. (See Fig. 12D-7)



Fig. 12D-4: Bumper Cover, Backside



Fig. 12D-5: Bumper Cover, Bumper Opening



Fig. 12D-7: Bumper Cover, Overall

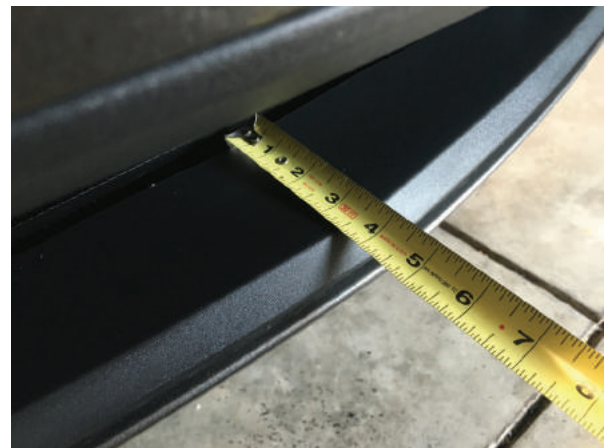

Fig. 12D-6: Bumper Cover, Centerline

12. BUMPER COVER/FRONT FASCIA MODIFICATION AND REINSTALLATION, cont'd

- E. Once all trimming is complete, reinstall the front bumper cover:
- Hang the bumper cover from the mounting tabs just inboard of the headlights, making sure it rests on top of the black plastic cover above the grille and radiator.
 - Reconnect the driving lights.
 - Reconnect the parking lights.
 - Spread the sides of the bumper apart and around the support structure in front of the front wheels, sandwiching the splash shields between the cover and the structure.
 - Reconnect the bumper cover to the bottom edges of the front fenders by pressing inward until each of the clips (3 per side) snaps into place.
 - Reinstall the four (4) OEM 7mm-headed fasteners forward of the front wheels (2 per side). (See Fig. 12D-1)
 - Reinstall the two(2) 10mm-headed fasteners near the bumper cover upper mounting tabs, just inboard of each headlight (1 per side). (See Fig. 12D-2)
 - Reinstall the remaining four (4) plastic pins securing the black plastic cover above the grille and radiator.



Fig. 12D-1: Splash Shields



Fig. 12D-2: Top Edge Fasteners

12. BUMPER COVER/FRONT FASCIA MODIFICATION AND REINSTALLATION, cont'd

- i. Reinstall the black plastic front undertray, trimming for clearance to the discharge ducting. Secure with the five (5) OEM 7mm-headed fasteners. (See Fig. 12D-3)
- j. Reinstall the four (4) 7mm-headed fasteners under the front bumper cover in front of the lip. (See Fig. 12D-4)



Fig. 12D-3: Plastic Undertray Trimming



Fig. 12D-4: Bumper Cover Lip

13. OIL FEED INSTALLATION (OIL-FED UNITS ONLY)

- A. Locate the supercharger oil feed port on the passenger side of the supercharger. (See Fig. 13A)
- B. Remove the blue plastic plug from the supercharger oil feed port and install the included -4AN male fitting. (See Fig. 13B)

NOTE: Use only clean engine oil on the pipe threads. Teflon tape or pipe sealant is not recommended as it might loosen and cause blockage of the small oil feed orifice resulting in possible supercharger failure.

- C. Connect the 90° end of the included -4AN braided oil feed hose to the supercharger oil feed fitting. Route the hose downward and toward the driver side between the supercharger discharge and the forward mounting plate. (See Fig. 13C)
- D. Continue routing the oil feed hose to the lower driver side area of the engine, passing it rearward between the alternator and the engine oil filter. **Use extra care to secure the hose away from moving parts and sharp edges.**

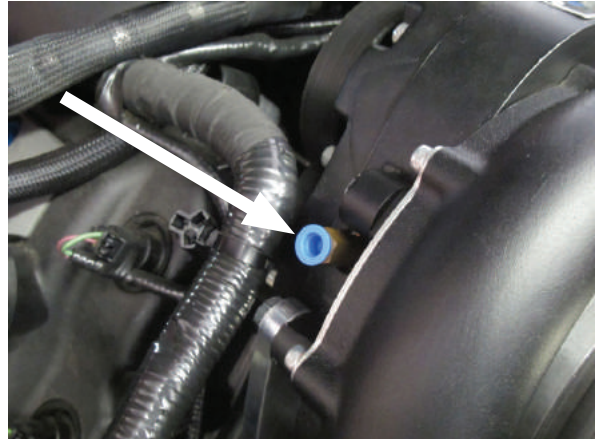

Fig. 13A: Supercharger Oil Feed Location



Fig. 13B: -4AN Oil Feed Fitting Installed



Fig. 13C: 90° Oil Feed Hose Installed

13. OIL FEED INSTALLATION (OIL-FED UNITS ONLY), cont'd

- E. Locate the OEM oil pressure sensor located just above and behind the engine oil filter. (See Fig. 13E)
- F. Disconnect the electrical connector from the OEM oil pressure sensor and remove the sensor itself by unthreading it from its 1/4" NPT port. Temporarily plug the port, as a small amount of oil may drain out.
- G. Install the supplied 1/4" NPT TEE fitting into the oil pressure sensor port and orient so one female port faces upward and one faces outward.

NOTE: Use only clean engine oil on the pipe threads. Teflon tape or pipe sealant is not recommended as it might loosen and cause blockage of the small oil feed orifice resulting in possible supercharger failure.

- H. Install the OEM oil pressure sensor into the upward-facing port of the TEE. (See Fig. 13H)
- I. Install the 1/4" NPT male x -4AN male 90° fitting into the outward-facing port of the TEE. Orient to point forward and slightly down. (See Fig. 13H)
- J. Reconnect the electrical connector to the OEM oil pressure sensor.
- K. Connect the straight end of the previously-installed -4AN braided hose to the -4AN male 90° fitting installed into the TEE, routing the hose between the alternator and oil filter. (See Fig. 13K)
- L. Confirm that all oil feed fittings are secure and that the hose is secured in a smooth path free of kinks and away from moving parts and sharp edges.



Fig. 13E: OEM Oil Pressure Sensor

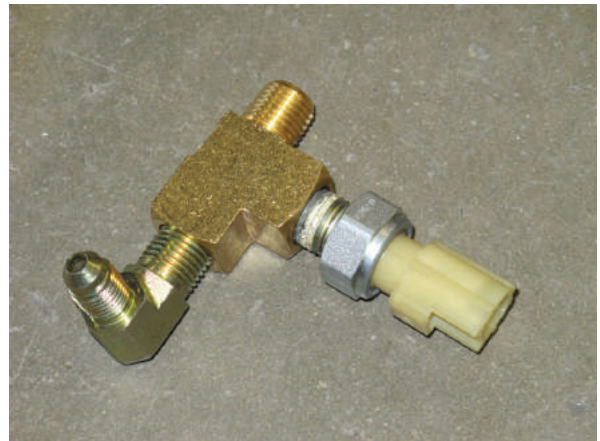

Fig. 13H: Oil Feed Assembly
(shown removed for clarity)

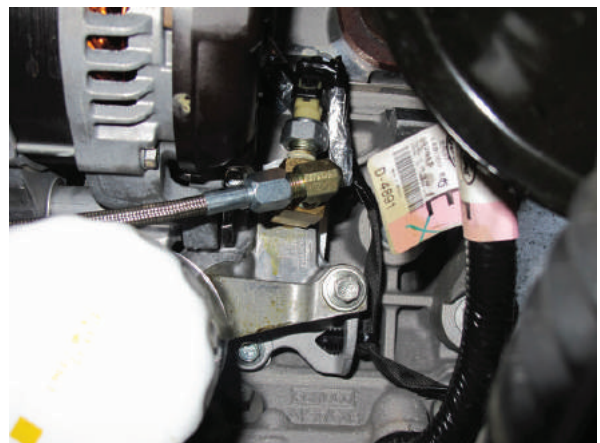

Fig. 13K: Oil Feed Assembly Orientation

14. OIL DRAIN INSTALLATION (OIL-FED UNITS ONLY)

NOTE: To provide an oil drain for the supercharger, it is necessary to make a hole in the oil pan. It is best to *punch* the hole rather than to drill it.

- A. Locate the wiring harness secured to the front edge of the oil pan. Remove the two (2) 10mm nuts securing the wiring harness mounting brackets (one on each side of the crankshaft), allowing the harness to be pulled downward for improved access to the front face of the oil pan. (See Fig. 14A)
- B. Mark the location for the oil drain fitting on the smooth portion of the front face of the oil pan toward the passenger side, approximately 5/8" down from the oil pan mounting flange. (See Fig. 14B; also see Fig. 14-1 at the end of this section)
- C. Remove paint from the area around the hole location.
- D. Use a small center punch to perforate the pan and expand the hole. Switch to a larger diameter punch and expand the hole further to approximately $\text{Ø}9/16$ ". Most punches are made from hexagon material and may be placed in a socket with an extension to make this procedure easier. (See Fig. 14D)
- E. Tap the hole with a 3/8" NPT tap approximately 1/4" deep. Pack the flutes of the tap with heavy grease to hold chips. Use a small magnet to check for any stray chips.

NOTE: This method of rolling over the lip of the hole and tapping it works very well if carefully done and should cause no problems.

- F. Thoroughly clean the threaded area. Apply a small amount of silicone sealer or Teflon paste to the new threads. Apply more sealer to the included 3/8" NPT hose barb fitting and install the fitting into the hole, making sure a seal is formed all around the fitting.
- G. Change the engine oil and filter to flush out any contaminants that may have entered the oil pan.



Fig. 14A: Wiring Harness Mounting Location (pass. side shown, driver side similar)



Fig. 14B: Oil Drain Fitting Installation Location



Fig. 14D: Punching Hole in Oil Pan

14. OIL DRAIN INSTALLATION (OIL-FED UNITS ONLY), cont'd

- H. Locate the oil drain hose previously attached to the barb fitting on the bottom of the supercharger. Trim the hose to length and secure to the barbed drain fitting on the front of the oil pan with an included worm gear clamp.

NOTE: Use extra care to secure the drain hose away from moving parts and sharp edges. It is important that the hose travels downhill for its entire length.

- I. Resecure the wiring harness running in front of the oil pan, using the included brass spacers to relocate the harness downward for drain hose clearance. (See Fig. 14I)

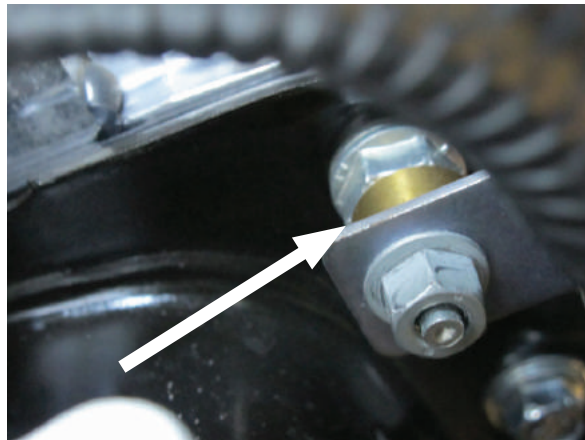

Fig. 14I: Wiring Harness Spacer

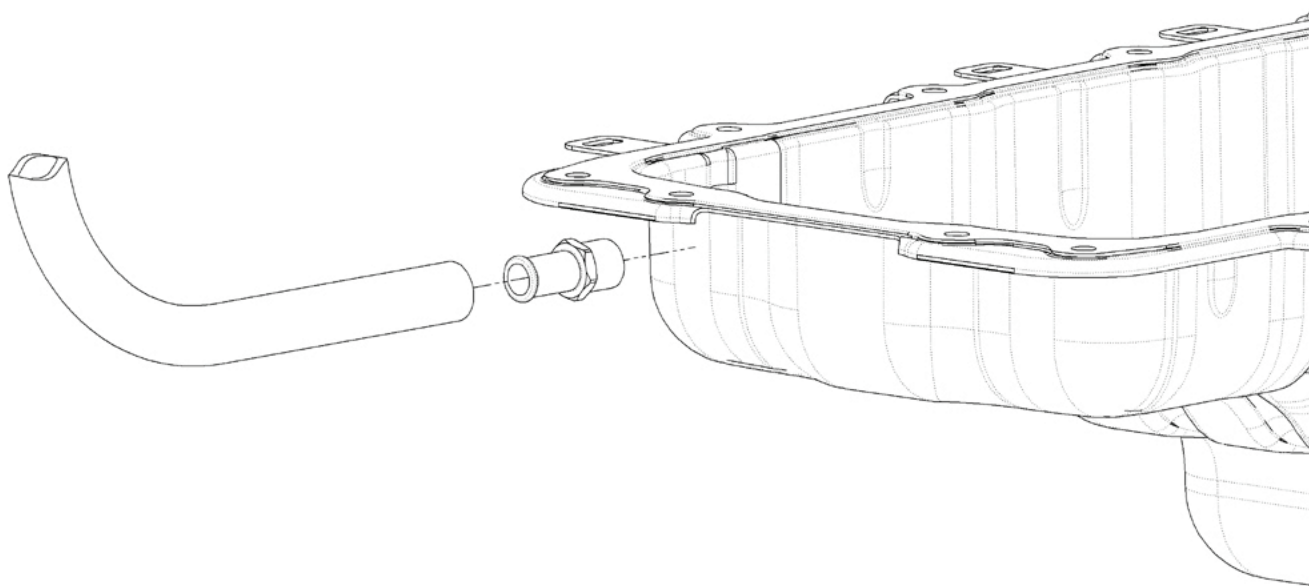

Fig. 14-1: Oil Drain Fitting Placement

15. REFLASH COMPUTER

IMPORTANT! To ensure trouble-free programming of your vehicle's computer:

- Make sure the vehicle's battery is sufficiently charged.
- Turn off all accessories and close doors to prevent unnecessary drain on the battery.
- Do not attempt to program your vehicle while a battery charger is connected.
- Improper battery voltage will result in failure of the programming process.
- Do not disconnect the cable or turn off the ignition during programming unless prompted to do so.

- Reconnect the battery.
- With the vehicle off, locate the vehicle's OBD2 port located in the lower left hand corner of the dash on the driver side of the vehicle. (See Fig. 15B) Make sure this connector is seated all the way into the vehicle's OBD2 port. Do not allow this connector to become disconnected during programming or damage may occur to the vehicle's ECM.
- The Reflash tool will power up and display "Program Vehicle". Press ENTER.
- In order to use the SCT Flash tool, you must agree to the terms set forth by SCT Flash. Press ENTER to agree.
- Follow the on-screen prompts to step through the reflash process.
 - When prompted to turn the key on, do so and wait for the vehicle to fully "boot up" When ready, press ENTER.
 - When prompted to "Select Vehicle" select "Mustang GT HO", then press ENTER.
 - The name of the tune being loaded will come up on the screen. Press ENTER.
 - The first phase of the reflash process will now begin.
 - After the process is done finalizing, you will be prompted to turn the key off. Once the key is off, the reflash tool will automatically proceed to the next step.
 - The reflash tool will now prompt you to turn the key on, but do not turn on the engine. Proceed to turn the key to the on position. The reflash tool will automatically proceed to unlock the processor and begin to set it up.
 - Now the reflash tool will begin to load the Vortech tune to your vehicle.
 - When the tune is loaded, the reflash tool will proceed to clear any DTC's.
- The reflash process is now complete. You may unplug the reflash tool from the OBD2 port at this time.



Fig. 15B: OBD2 Connector and Port



Fig. 15C: Flash Tool

NOTE: The red dot at the center of the D-Pad on the SCT Flash tool acts as the "ENTER" button.

16. FINAL CHECK

WARNING: Do not attempt to operate the vehicle until all components are installed and all operations are completed including the final check.

- A. If your vehicle has gone over 15,000 miles since its last spark plug change, you will need to change the spark plugs now *before* test driving the vehicle.
- B. Check all fittings, nuts, bolts and clamps for tightness. Pay particular attention to oil and fuel lines around moving parts, sharp edges, and exhaust system parts. Make sure all wires and lines are properly secured with clamps or tie-wraps.
- C. Check all fluid levels, making sure that your tank is filled with 91 octane or higher fuel before commencing test drive.
- D. Start the engine and allow to idle a few minutes, then shut off.
- E. Recheck to be sure that no hoses, wires, etc. are near exhaust headers or moving parts. Look also for any signs of fluid leakage.
- F. **PLEASE TAKE SPECIAL NOTE:** Operating the vehicle without ALL of the subassemblies completely and properly installed may cause **FAILURE OF MAJOR COMPONENTS.**
- G. Test drive the vehicle.
- H. Always listen carefully for engine detonation. Discontinue heavy throttle usage if detonation is heard.
- I. Read the **STREET SUPERCHARGER SYSTEM OWNER'S MANUAL AND RETURN THE WARRANTY REGISTRATION FORM** within thirty (30) days of purchasing your supercharger system to qualify.

For internally lubricated SL units only

This supercharger has been factory pre-filled with special Paxton synthetic lubricant. Oil does not need to be added to a brand new unit, however a fluid level check should be performed.

Prior to operating the supercharger on the vehicle and after installation onto the vehicle:

Remove the factory installed flat-head brass shipping plug (not the dipstick) from the top of the supercharger case. Replace the sealed shipping plug with the supplied vented plug. Do not operate the supercharger without it. Check the supercharger fluid level using the dipstick as follows:

Fluid level checking procedure:

1. Ensure that the .06" copper sealing washer is located on the dipstick base.
2. Thread the clean dipstick into the unit until it seats.
3. Once the dipstick has seated, remove the dipstick from the unit. Fluid should register in the crosshatched area on the dipstick.
4. **DO NOT OVERFILL!!!** Drain excess fluid from the unit if it is above the maximum level on the dipstick.

Check the fluid level using the dipstick at least every 2,500 miles.

Initial supercharger fluid change must be performed at 2,500 miles. The supercharger fluid must be changed every 7,500 miles maximum thereafter.

Drain the fluid, refill the unit with 4 oz. of Paxton SL lubricating fluid, and then confirm proper oil level using the dipstick. **DO NOT OVERFILL!!!**

WARNING: Use of any fluid other than the special Paxton lubricant will void the warranty and may cause component failure.



**Paxton Automotive . 1300 Beacon Place . Oxnard CA 93033
888 9-PAXTON • FAX 805 247-0669**