

Ford 4.6L 3V Mustang GT Supercharger System Installation Instructions

2005-2010 Model Year*
50-State Smog Legal per C.A.R.B. EO #D-213-27

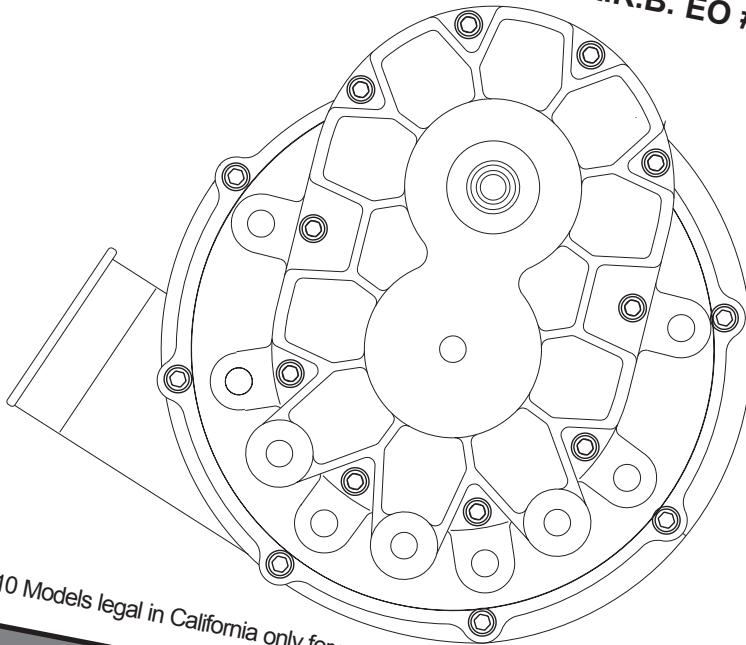

* 2007-2010 Models legal in California only for racing vehicles which may never be used upon a highway.



ENGINEERING, LLC

1650 Pacific Avenue, Channel Islands CA 93033-9901 • Phone: 805 247-0226
Fax: 805 247-0669 • www.vortechsuperchargers.com • M-F 8:00AM - 4:30PM (PST)

FOREWORD

This manual provides information on the installation, maintenance and service of the Vortech supercharger kit expressly designed for this vehicle. All information, illustrations and specifications contained herein are based on the latest product information available at the time of this publication. Changes to the manual may be made at any time without notice. Contact Vortech Engineering for any additional information regarding this kit and any of these modifications at (805) 247-0226 8:00am-4:30pm PST.



Take note of the following before proceeding:

1. Proper installation of this supercharger kit requires general automotive mechanic knowledge and experience. Please browse through each step of this instruction manual prior to beginning the installation to determine if you should refer the job to a professional installer/technician. Please contact your dealer or Vortech Engineering for possible installers in your area.
2. This product was designed for use on stock (un-modified, OEM) vehicles. The PCM (computer), engine, transmission, drive axle ratios and tire O.D. must be stock. If the vehicle or engine has been modified in any way, check with Vortech prior to installation and use of this product.
3. Use only premium grade fuel with a minimum of 91 octane (*R+M/2*).
4. Always listen for any sign of detonation (*knocking/pinging*) and discontinue hard use (*no boost*) until problem is resolved.
5. Vortech is not responsible for any clutch, transmission, drive-line or engine damage.

Exclusions from Vortech warranty coverage considerations include, but not limited to:

1. Neglect, abuse, lack of maintenance, abnormal operation or improper installation.
2. Continued operation with an impaired vehicle or sub-system.
3. The combined use of Vortech components with other modifications such as, but not limited to, exhaust headers, aftermarket camshafts, nitrous oxide, third party PCM programming or other such changes.

©2010 b VORTECH ENGINEERING, LLC

All rights reserved. No part of this publication may be reproduced, transmitted, transcribed, or translated into another language in any form, by any means without written permission of Vortech Engineering, LLC.

TABLE OF CONTENTS

FOREWORD	ii
TABLE OF CONTENTS	
IMPORTANT NOTES	iv
TOOL & SUPPLY REQUIREMENTS	v
PARTS LIST (2005-2006 Mustang GT, Standard)	vi
PARTS LIST (2005-2006 Mustang GT, Standard) Internally Lubricated	vii
PARTS LIST (2005-2006 Mustang GT, H.O.)	vii
PARTS LIST (2005-2006 Mustang GT, H.O.) Internally Lubricated	x
PARTS LIST (2007-2008 Mustang GT, Standard)	ix
PARTS LIST (2007-2008 Mustang GT, Standard) Internally Lubricated	xiii
PARTS LIST (2007-2008 Mustang GT, H.O.)	x
PARTS LIST (2007-2008 Mustang GT, H.O.) Internally Lubricated	xvi
PARTS LIST (2008 Mustang Bullitt) Internally Lubricated	xviii
PARTS LIST (2010 Mustang GT, Standard) Internally Lubricated	xx
PARTS LIST (2010 Mustang GT, H.O.) Internally Lubricated	xxii
1. PREPARATION/REMOVAL	1
2. OIL FEED INSTALLATION	5
3. OIL DRAIN ASSEMBLY INSTALLATION	6
4. POWER STEERING RELOCATION	7
4.1 POWER STEERING RELOCATION (2010 Only)	8
5.1 COOLANT TUBE RELOCATION (2005-2006 Only)	9
5.2 THERMOSTAT HOUSING/RADIATOR HOSE MODIFICATION (2007-2010 Model Year Only)	12
6.1 PULLEY AND SPACER REPLACEMENT (Bullet/V-Power Only)	14
6.2 SUPERCHARGER MOUNTING PLATE INSTALLATION	18
7. THERMOSTAT HOUSING RELOCATION (2005-2006 Only)	21
8. CHARGE AIR COOLER INSTALLATION (H.O. Kits Only)	23
8.A BUMPER COVER AND SPLASH PAN	23
8.B CHARGE AIR COOLER ASSEMBLY INSTALLATION (H.O. Kits Only)	26
8.C ENGINE COOLANT RESERVOIR INSTALLATION (2005-2006 Models Only)	34
8.D RADIATOR HOSE MODIFICATIONS (2005-2006 Models Only)	37
8.E ENGINE COOLANT RESERVOIR INSTALLATION (2007-2010 Models Only)	38
8.F COOLER CORE INSTALLATION	41
8.G COOLANT RESERVOIR FILL	42
8.1 2010 MUSTANG BUMPER TRIMMING (2010 Models Only)	43
8.2 COMPRESSOR BYPASS VALVE ASSEMBLY INSTALLATION	45
8.3 COMPRESSOR BYPASS VALVE ASSEMBLY INSTALLATION (V-Power/Bullitt)	46
9. AIR DISCHARGE ASSEMBLY (Non-cooled Kits Only)	47
10. COMPRESSOR BY-PASS VALVE INSTALLATION (Non-cooled kits only)	48
11. COOLANT RESERVOIR RE-INSTALLATION (Non-cooled Kits Only)	49
12. CRANK CASE BREATHER AND PCV INSTALLATION	50
13. AIR INLET ASSEMBLY	51
14. FUEL PUMP UPGRADE	54
15. REFLASH COMPUTER	57
16. FINAL CHECK	58

NOTICE

This product is protected by state common law, copyright and/or patent. All legal rights therein are reserved. The design, layout, dimensions, geometry, and engineering features shown in this product are the exclusive property of Vortech Engineering, LLC. This product may not be copied or duplicated in whole or part, abstractly or fundamentally, intentionally or fortuitously, nor shall any design, dimension, or other information be incorporated into any product or apparatus without prior written consent of Vortech Engineering, LLC.

2005-2010 Mustang GT

Installation Instructions

Congratulations on selecting the best performing and best backed automotive supercharger available today... the VORTECH® supercharger!

Before beginning this installation, please read through this entire instruction booklet and the Street Supercharger System Owner's Manual which includes the Limited Warranty Program, the Warranty Registration form and return envelope.

Vortech supercharger systems are performance improving devices. In most cases, increases in torque of 30-35% and horsepower between 35-45% can be expected with the boost levels specified by Vortech Engineering. This product is intended for use on healthy, well maintained engines. Installation on a worn-out or damaged engine is not recommended and may result in failure of the engine as well as the supercharger. Vortech Engineering is not responsible for engine damage.

Installation on new vehicles will not harm or adversely affect the break-in period so long as factory break-in procedures are followed.

For best performance and continued durability, please take note of the following key points:

1. Use only premium grade fuel 91 octane or higher (R+M/2).
2. The engine must have stock compression ratio.
3. If the engine has been modified in any way, check with Vortech prior to using this product.
4. Always listen for any sign of detonation (pinging) and discontinue hard use (no boost) until problem is resolved.
5. Perform an oil and filter change upon completion of this installation and prior to test driving your vehicle. Thereafter, always use a high grade SF rated engine oil or a high quality synthetic, and change the oil and filter at least every 3,000 miles. Never attempt to extend the oil change interval beyond 3,000 miles, regardless of oil manufacturer's claims as potential damage to the supercharger may result.
6. Before beginning installation, replace all spark plugs that are older than 1-year or 15,000 miles with original heat range plugs as specified by the manufacturer and reset timing to factory specifications (follow the procedures indicated within the factory repair manual and/or as indicated on the factory underhood emissions tag). Do not use platinum spark plugs unless they are original equipment. Change spark plugs every 20,000 miles.

TOOL & SUPPLY REQUIREMENTS

- Factory repair manual
- 3/8" socket and drive set: SAE & metric
- 1/2" socket and drive set: SAE & metric
- 3/8"NPT tap, 3/8-18 tap & handle
- Adjustable wrench
- Open end wrenches: 3/8", 7/16", 1/2", 9/16"
- Center punch and a 5/8" tapered punch
- 6 quarts (or what is specified in your owner's manual)
SF rated quality engine oil, oil filter and wrench

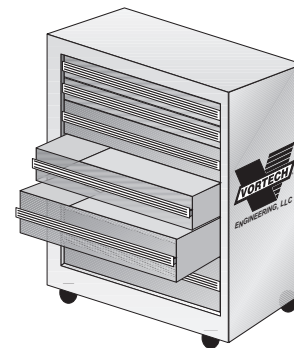

If it has been 15,000 miles or more since your vehicle's last spark plug change, then you will also need:

- Spark plug socket
- NEW spark plugs



2005-2006 Mustang GT, Standard

Part No. 4FU218-010SQ/018SQ

PARTS LIST

IMPORTANT: Before beginning installation, verify that all parts are included in the kit. Report any shortages or damaged parts immediately.

PART NO.	DESCRIPTION	QTY.	PART NUMBER	DESCRIPTION	QTY.
2E229-230	V2-S SUPERCHARGER ASY	1	7U133-050	1.5" X 90° HOSE, LONG LEG	1
4FU130-036	OIL DRAIN ASSY	1	7U133-190	HOSE, COOLNT DRIV SIDE 05 MUST	1
7U030-036	1/2" OIL DRAIN HOSE	2.5	7U038-000	3/4" HEATER HOSE	3.5
7R001-008	#8 HOSE CLAMP	2	7P375-075	3/4" HOSE BARB UNION, BRASS	1
7P375-017	3/8NPT X 1/2 BEADED HSE BRB	1	7R002-020	#20 HOSE CLAMP	4
4FU130-026	OIL FEED ASY	1	7R002-024	#24 HOSE CLAMP	2
7U250-090-260	OIL FEED HOSE, 26" -4X90°	1	7P125-002	FREEZE PLUG, 1.25 DIA, .25 TAL	1
7P125-005	1/8 NPT STR. X -4 JIC FTG STL	1	7R002-010	#10 HOSE CLAMP	4
7P250-091	1/4 NPT 90° X -4JIC FTG STL	1	7P125-016	1/8 NPT PLUG	1
7P250-034	1/4 NPT X 1/4 NPT STRT T	1	4FU110-010	P/S RESERVOIR RELOCATION	1
4FU112-020	DISCHARGE ASY	1	7P375-075	3/4" HOSE BARB UNION, BRASS	1
4FU012-020	DUCT, DISCH, MUST GT STD	1	7P375-050	3/8" HOSE UNION, BRASS	1
7S450-200	SLEEVE, 4 1/2 X 2, BLUE	1	7R001-004	#4 HOSE CLAMP	2
7S300-276	REDUCER, 3.0 X 2.75 X 2.5L	1	7R001-008	#8 HOSE CLAMP	2
7R002-044	#44 HOSE CLAMP	1	7U038-030	HOSE, P/S, 3/4 ID	3
7R002-048	#48 HOSE CLAMP	1	7U032-016	3/8" EFI FUEL HSE HI-PSR	3
7R002-072	#72 HOSE CLAMP	2	7A250-075	1/4-20 X .75 SHCS PLTD	1
7R002-016	#16 HOSE CLAMP	4	7J250-001	1/4 WASHER, SAE, PLTD	2
7U030-046	5/32" VACUUM LINE	5	7F250-021	1/4-20 NYLOCK NUT ZINC PLATED	1
8D001-001	STD COMPRESS BYPASS VALVE	1	4FU010-010	P/S RELOC BRKT, 05 GT MUST	1
7U034-016	1" GS HEATER HOSE	1.25	7U100-055	TIE WRAP, 7.5" NYLON	4
7U034-016	1" GS HEATER HOSE	0.583	8F060-048	FUEL INJ, 39LB EV6, OEM 03 COB	8
7P218-156	VAC TEE, 7/32,7/32,5/32	1	008110	SMALL SILVER DIE CUT DECAL	2
4FU112-010	AIR INTAKE ASY	1	008444	3 YR S/C WARRANTY PKG	1
4FU012-010	INLET DUCT,"A"	1	008130	LICENSE PLATE FRAME, VORTECH	1
4FU012-015	INLET DUCT,"B"	1	4FU020-010	INSTR MAN 05-08 MUST GT	1
7R002-056	#56 HOSE CLAMP	1	5A003-035	PREDATOR, 05-08 MUSTANG	1
7S400-200	SLEEVE, 4 X 2, BLUE	2	8F101-262	FUEL PMP ASY,05 MUST TWIN INTA	1
7S400-351	REDUCER SLV 4.00 X 3.5 X 2.35L	1	7U032-018	3/8" SUBMERSIBLE EFI FUEL HOSE	2.75
7R002-064	#64 HOSE CLAMP	5	7U100-055	TIE WRAP, 7.5" NYLON	4
8H040-235	AIR FILTER, 4.0FLG X 7.0L	1	7R004-002	STEPLESS CLAMP, 17.0-70	2
8A003-071	MAF, 3.8 I.D. MUSTANG GT	1	8F001-255	255 INTANK FUEL PUMP '86-'97	1
7P750-102	3/4NPT X 1" X 90° HSE FIT	1	7R002-044	#44 HOSE CLAMP	1
7P250-047	1/4NPT TO 3/8"BARB 90°	1	7R004-006	STEPLESS CLAMP, 11.3 X 5MM WID	4
4FU010-071	BRKT, INTAKE SUPPORT	1	5W001-022	T-TAP CONN,14-16 AWG	2
7U032-016	3/8" EFI FUEL HSE HI-PSR	4	5W001-009	16-14GA MALE SLIDE INSULATED	2
4FU013-010	COVER, AIR FILTER, MUST GT	1	5W001-080	FUSE, 20 AMP. MINI BLADE	1
7C040-008	M4-.7X8MM SCHD SS	2	7P375-099	Y-UNION, 3/8" BARBED TEFLON	1
4FU111-044	S/C MOUNTING BRKT ASY	1	7U032-025	HOSE, 5/16" ID,3/8"OD, 1/32" W	0.125
4FU010-044	S/C MOUNT PLT, MUST GT	1	7U032-030	HOSE, SPIRAL 3/8" CUFF ID, 1" L	2
4FU010-034	IDLER MOUNT PLATE, MUST	1	4FU101-001	MAF EXT MOD 05+ MUSTANG	1
4FU017-011	SPACER, STUDDER MUST GT	2	5W018-030	18GA STRD WIRE GREY	1
2A017-750-05	SPACER, .750 OD X 2.691 LONG	2	5W018-010	18GA STRD WIRE RED	1
2A017-750-06	SPACER, .750 OD X 2.712 LONG	1	5W018-020	18GA STRD WIRE BLK, UL1015	1
2A017-879-08	SPACER, .875 OD X 1.776 LONG	1	5W018-080	18GA STRD WIRE BLUE BULK	1
2A017-750-07	SPACER, .750 OD X .097 LONG	1	5W018-090	18GA STRD WIRE BROWN BULK	1
4FU017-021	SPACER, IDLER, MUST GT	1	5W018-100	18GA STRD WIRE PURPLE	1
4PCS016-160	PULLEY, IDLER	1	5W001-007	3/16" HEAT-SHRINK TUBING	1.5
2A046-120	BELT, GATES K061203	1	5W001-005	3/8" PLASTIC WIRE LOOM	1.5
7A375-375	3/8-16 X 3-3/4 HX HD	1	5W001-012	18-22 GA BUTT CONN RED INSUL	12
7C080-150	M8 X 1.25 X 150MM HXHD CL10.9	1			
7C080-140	M8 X 1.25 X 140 HXHD CL8.8	2			
7A375-100	3/8-16 X 1 G5 HHCS, PLT	7			
7K312-030	5/16 AN WASHER, S.S.	2			
7K375-040	3/8 AN960 FLAT WASHR PLATED	10			
4FU139-096	PCV MOD ASY	1			
7P375-106	PCV VALVE, FORD, 3/8" HOSE	1			
7P625-377	5/8" -3/8" REDUCER BARB UNION	1			
7R004-002	STEPLESS CLAMP, 17.0-70	2			
7R004-004	STEPLESS CLAMP, 1.0 OD HOSE	3			
7R004-007	STEPLESS CLAMP, 28.6 X 7MM WID	1			
7U032-016	3/8" EFI FUEL HSE HI-PSR	0.25			
7U033-020	HOSE, 5/8"ID CLASS 1 EMISSIONS	0.66667			
4FU214-021	COOL BYP HOSE RELOC ASY	1			
4FU114-021	ASY, WATER OUTLET, 05 MUST GT	1			
7J875-010	7/8 SEALING WASHER	1			
7F875-010	NUT, 7/8-14, SHORT/JAM	1			

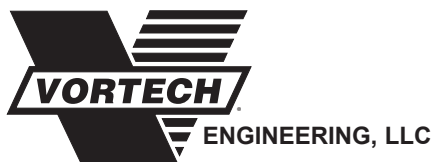

2005-2006 Mustang GT, Standard

Part No. 4FU218-010L/018L

PARTS LIST

IMPORTANT: Before beginning installation, verify that all parts are included in the kit. Report any shortages or damaged parts immediately.

PART NO.	DESCRIPTION	QTY.	PART NUMBER	DESCRIPTION	QTY.
008110	SMALL SILVER DIE CUT DECAL	2	7P625-377	5/8" -3/8" REDUCER BARB UNION	1
008130	LICENSE PLATE FRAME	1	7R004-002	STEPLESS CLAMP, 17.0-70	2
008447	1 YR S/C WARRANTY PKG	1	7R004-004	STEPLESS CLAMP, 1.0 OD HOSE	3
009035	S/C LUBE, BOTTLED, 3-PACK	1	7R004-007	STEPLESS CLAMP, 28.6 X 7MM WID	1
2F329-010	V3 SUPERCHARGER ASY, STD	1	7U032-016	3/8" EFI FUEL HSE HI-PSR	0.25
4FU020-010	INSTR MAN 05-08 MUST GT	1	7U033-020	HOSE, 5/8"ID CLASS 1 EMISSIONS	0.66667
4FU110-010	P/S RESERVOIR RELOCATION	1	4FU214-021	COOL BYP HOSE RELOC ASY	1
7P375-075	3/4" HOSE BARB UNION, BRASS	1	4FU114-021	ASY, WATER OUTLET, 05 MUST GT	1
7P375-050	3/8" HOSE UNION, BRASS	1	7J875-010	7/8 SEALING WASHER	1
7R001-004	#4 HOSE CLAMP	2	7F875-010	NUT, 7/8-14, SHORT/JAM	1
7R001-008	#8 HOSE CLAMP	2	7U133-050	1.5" X 90° HOSE, LONG LEG	1
7U038-030	HOSE, P/S, 3/4 ID	3	7U133-190	HOSE, COOLNT DRIV SIDE 05 MUST	1
7U032-016	3/8" EFI FUEL HSE HI-PSR	3	7U038-000	3/4" HEATER HOSE	3.5
7A250-075	1/4-20 X .75 SHCS PLTD	1	7P375-075	3/4" HOSE BARB UNION, BRASS	1
7J250-001	1/4 WASHER, SAE, PLTD	2	7R002-020	#20 HOSE CLAMP	4
7F250-021	1/4-20 NYLOCK NUT ZINC PLATED	1	7R002-024	#24 HOSE CLAMP	4
4FU010-010	P/S RELOC BRKT, 05 GT MUST	1	7P125-002	FREEZE PLUG, 1.25 DIA, .25 TAL	1
7U100-055	TIE WRAP, 7.5" NYLON	4	7R002-010	#10 HOSE CLAMP	4
4FU111-044	S/C MOUNTING BRKT ASY	1	7P125-016	1/8 NPT PLUG	1
4FU010-044	S/C MOUNT PLT, MUST GT	1	5A003-035	PREDATOR, 05-08 MUSTANG	1
4FU010-034	IDLER MOUNT PLATE, MUST	1	8F060-048	FUEL INJ, 39LB EV6, OEM 03 COB	8
4FU017-011	SPACER, STUDDED MUST GT	2	8F101-262	FUEL PMP ASY,05 MUST TWIN INTA	1
2A017-750-05	SPACER, .750 OD X 2.691 LONG	2	7U032-018	3/8" SUBMERSIBLE EFI FUEL HOSE	2.75
2A017-750-06	SPACER, .750 OD X 2.712 LONG	1	7U100-055	TIE WRAP, 7.5" NYLON	4
2A017-879-08	SPACER, .875 OD X 1.776 LONG	1	7R004-002	STEPLESS CLAMP, 17.0-70	2
2A017-750-07	SPACER, .750 OD X .097 LONG	1	8F001-255	255 INTANK FUEL PUMP '86-'97	1
4FU017-021	SPACER, IDLER, MUST GT	1	7R002-044	#44 HOSE CLAMP	1
4PCS016-160	PULLEY, IDLER	1	7R004-006	STEPLESS CLAMP, 11.3 X 5MM WID	4
2A046-120	BELT, GATES K061203	1	5W001-022	T-TAP CONN,14-16 AWG	2
7A375-375	3/8-16 X 3-3/4 HX HD	1	5W001-009	16-14GA MALE SLIDE INSULATED	2
7C080-150	M8 X 1.25 X 150MM HXHD CL10.9	1	5W001-080	FUSE, 20 AMP, MINI BLADE	1
7C080-140	M8 X 1.25 X 140 HXHD CL8.8	2	7P375-099	Y-UNION, 3/8" BARBED TEFLON	1
7A375-100	3/8-16 X 1 G5 HHCS, PLT	7	7U032-025	HOSE, 5/16" ID,3/8"OD, 1/32" W	0.125
7K312-030	5/16 AN WASHER, S.S.	2	7U032-030	HOSE, SPIRAL 3/8" CUFF ID, 1' L	2
7K375-040	3/8 AN960 FLAT WASHR PLATED	10	4FU101-001	MAF EXT MOD 05+ MUSTANG	1
4FU112-010	AIR INTAKE ASY	1	5W018-030	18GA STRD WIRE GREY	1
4FU012-010	INLET DUCT,"A"	1	5W018-010	18GA STRD WIRE RED	1
4FU012-015	INLET DUCT,"B"	1	5W018-020	18GA STRD WIRE BLK, UL1015	1
7R002-056	#56 HOSE CLAMP	1	5W018-080	18GA STRD WIRE BLUE BULK	1
7S400-200	SLEEVE, 4 X 2, BLUE	2	5W018-090	18GA STRD WIRE BROWN BULK	1
7S400-351	REDUCER SLV 4.00 X 3.5 X 2.35L	1	5W018-100	18GA STRD WIRE PURPLE	1
7R002-064	#64 HOSE CLAMP	5	5W001-007	3/16" HEAT-SHRINK TUBING	1.5
8H040-235	AIR FILTER, 4.0FLG X 7.0L	1	5W001-005	3/8" PLASTIC WIRE LOOM	1.5
8A003-071	MAF, 3.8 I.D. MUSTANG GT	1	5W001-012	18-22 GA BUTT CONN RED INSUL	12
7P750-102	3/4NPT X 1" X 90° HSE FIT	1			
7P250-047	1/4NPT TO 3/8"BARB 90°	1			
4FU010-071	BRKT, INTAKE SUPPORT	1			
7U032-016	3/8" EFI FUEL HSE HI-PSR	4			
4FU013-010	COVER, AIR FILTER, MUST GT	1			
7C040-008	M4-.7X8MM SCHD SS	2			
4FU112-020	DISCHARGE ASY	1			
4FU012-020	DUCT, DISCH, MUST GT STD	1			
7S450-200	SLEEVE, 4 1/2 X 2, BLUE	1			
7S300-276	REDUCER, 3.0 X 2.75 X 2.5L	1			
7R002-044	#44 HOSE CLAMP	1			
7R002-048	#48 HOSE CLAMP	1			
7R002-072	#72 HOSE CLAMP	2			
7R002-016	#16 HOSE CLAMP	4			
7U030-046	5/32" VACUUM LINE	5			
8D001-001	STD COMPRESS BYPASS VALVE	1			
7U034-016	1" GS HEATER HOSE	1.25			
7U034-016	1" GS HEATER HOSE	0.583			
7P218-156	VAC TEE, 7/32,7/32,5/32	1			
4FU139-096	PCV MOD ASY	1			
7P375-106	PCV VALVE, FORD, 3/8" HOSE	1			



ENGINEERING, LLC

2005-2006 Mustang GT, H.O.

Part No. 4FU218-020SQ

PARTS LIST

IMPORTANT: Before beginning installation, verify that all parts are included in the kit. Report any shortages or damaged parts immediately.

PART NO.	DESCRIPTION	QTY.	PART NUMBER	DESCRIPTION	QTY.
008110	SMALL SILVER DIE CUT DECAL	2	7R004-004	STEPLESS CLAMP, 1.0 OD HOSE	3
008130	LICENSE PLATE FRAME	1	7R004-007	STEPLESS CLAMP, 28.6 X 7MM WID	1
008444	3 YR S/C WARRANTY PKG	1	7U032-016	3/8" EFI FUEL HSE HI-PSR	0.25
2E229-240	V2-S SUPERCHARGER ASY, H.O.	1	7U033-020	HOSE, 5/8"ID CLASS 1 EMISSIONS	0.66667
4FU020-010	INSTR MAN 05-08 MUST GT	1	4FU214-021	COOL BYP HOSE RELOC ASY	1
4FU110-010	P/S RESERVOIR RELOCATION	1	4FU114-021	ASY, WATER OUTLET, 05 MUST GT	1
7P375-075	3/4" HOSE BARB UNION, BRASS	1	7J875-010	7/8 SEALING WASHER	1
7P375-050	3/8" HOSE UNION, BRASS	1	7F875-010	NUT, 7/8-14, SHORT/JAM	1
7R001-004	#4 HOSE CLAMP	2	7U133-050	1.5" X 90° HOSE, LONG LEG	1
7R001-008	#8 HOSE CLAMP	2	7U133-190	HOSE, COOLNT DRIV SIDE 05 MUST	1
7U038-030	HOSE, P/S, 3/4 ID	3	7U038-000	3/4" HEATER HOSE	3.5
7U032-016	3/8" EFI FUEL HSE HI-PSR	3	7P375-075	3/4" HOSE BARB UNION, BRASS	1
7A250-075	1/4-20 X .75 SHCS PLTD	1	7R002-020	#20 HOSE CLAMP	4
7J250-001	1/4 WASHER, SAE, PLTD	2	7R002-024	#24 HOSE CLAMP	2
7F250-021	1/4-20 NYLOCK NUT ZINC PLATED	2	7P125-002	FREEZE PLUG, 1.25 DIA, .25 TAL	1
4FU010-010	P/S RELOC BRKT, 05 GT MUST	1	7R002-010	#10 HOSE CLAMP	4
7U100-055	TIE WRAP, 7.5" NYLON	4	7P125-016	1/8 NPT PLUG	1
4FU111-044	S/C MOUNTING BRKT ASY	1	5A001-025	DIABLO MAFIA	1
4FU010-044	S/C MOUNT PLT, MUST GT	1	5A003-035	PREDATOR, 05-08 MUSTANG	1
4FU010-034	IDLER MOUNT PLATE, MUST	1	8F060-048	FUEL INJ, 39LB EV6, OEM 03 COB	8
4FU017-011	SPACER, STUDDERED MUST GT	2	8F101-262	FUEL PMP ASY,05 MUST TWIN INTA	1
2A017-750-05	SPACER, .750 OD X 2.691 LONG	2	7U032-018	3/8" SUBMERSIBLE EFI FUEL HOSE	2.75
2A017-750-06	SPACER, .750 OD X 2.712 LONG	1	7U100-055	TIE WRAP, 7.5" NYLON	4
2A017-879-08	SPACER, .875 OD X 1.776 LONG	1	7R004-002	STEPLESS CLAMP, 17.0-70	2
2A017-750-07	SPACER, .750 OD X .097 LONG	1	8F001-255	255 INTANK FUEL PUMP '86-'97	1
4FU017-021	SPACER, IDLER, MUST GT	1	7R002-044	#44 HOSE CLAMP	1
4PCS016-160	PULLEY, IDLER	1	7R004-006	STEPLESS CLAMP, 11.3 X 5MM WID	4
2A046-120	BELT, GATES K061203	1	5W001-022	T-TAP CONN,14-16 AWG	2
7A375-375	3/8-16 X 3-3/4 HX HD	1	5W001-009	16-14GA MALE SLIDE INSULATED	2
7C080-150	M8 X 1.25 X 150MM HXHD CL10.9	1	5W001-080	FUSE, 20 AMP. MINI BLADE	1
7C080-140	M8 X 1.25 X 140 HXHD CL8.8	2	7P375-099	Y-UNION, 3/8" BARBED TEFLON	1
7A375-100	3/8-16 X 1 G5 HHCS, PLT	7	7U032-025	HOSE, 5/16" ID, 3/8"OD, 1/32" W	0.125
7K312-030	5/16 AN WASHER, S.S.	2	7U032-030	HOSE, SPIRAL 3/8" CUFF ID, 1' L	2
7K375-040	3/8 AN960 FLAT WASHR PLATED	10	8N101-290	WELDED CORE ASY	1
4FU112-010	AIR INTAKE ASY	1	8N104-125	SUPRT PCS, 05-08 MUST GT CLR G	1
4FU012-010	INLET DUCT,"A"	1	4FE014-010	RADIATOR PIPE-STAINLESS	1
4FU012-015	INLET DUCT,"B"	1	5W001-009	16-14GA MALE SLIDE INSULATED	1
7R002-056	#56 HOSE CLAMP	1	5W001-011	16-14 GA RING TERM. .26" HOLE	1
7S400-200	SLEEVE, 4 X 2, BLUE	2	5W001-015	FUSE, BLADE TYPE 20 AMP	1
7S400-351	REDUCER SLV 4.00 X 3.5 X 2.35L	1	5W001-022	T-TAP CONN,14-16 AWG	1
7R002-064	#64 HOSE CLAMP	5	5W001-032	1/4" PLASTIC WIRE LOOM	60
8H040-235	AIR FILTER, 4.0FLG X 7.0L	1	5W001-050	HARNES, FUEL INJ PLUG W/WIRES	1
8A003-071	MAF, 3.8 I.D. MUSTANG GT	1	5W001-071	FUSE HOLDER,16GA WIRE	1
7P750-102	3/4NPT X 1" X 90° HSE FIT	1	5W018-010	18GA STRD WIRE RED	5
7P250-047	1/4NPT TO 3/8"BARB 90°	1	7A250-050	1/4-20 X .50 SHCS ZINC PLTD	3
4FU010-071	BRKT, INTAKE SUPPORT	1	7A250-051	1/4-20 X .50 HHCS ZINC PLTD	2
7U032-016	3/8" EFI FUEL HSE HI-PSR	4	7A250-074	1/4-20 X .75 HHCS PLTD	2
4FU013-010	COVER, AIR FILTER, MUST GT	1	7F250-020	1/4-20 HEX NUT	2
7C040-008	M4-.7X8MM SCHED SS	2	7J006-093	6MM WASHER, PLATED	5
4FU114-010	RAD PIPE RELOC ASY, MUST GT	1	7J250-001	1/4 WASHER, SAE, PLTD	4
4FU014-010	RADIATOR PIPE, 05 GT MUST	1	7P156-082	5/32 TEE	1
7R002-024	#24 HOSE CLAMP	2	7P218-156	VAC TEE, 7/32,7/32,5/32	1
4FU130-026	OIL FEED ASY	1	7P375-075	3/4" HOSE BARB UNION, BRASS	4
7U250-090-260	OIL FEED HOSE, 26" -4X90°	1	7P500-026	1/2NPT X 3/4 BARB 90° BRASS	2
7P125-005	1/8 NPT STR. X -4 JIC FTG STL	1	7P500-078	1/2NPT X 3/4 HOSE FIT STRT	2
7P250-091	1/4 NPT 90° X -4JIC FTG STL	1	7R002-016	#16 HOSE CLAMP	4
7P250-034	1/4 NPT X 1/4 NPT STRT T	1	7R002-024	#24 HOSE CLAMP	2
4FU130-036	OIL DRAIN ASSY	1	7R002-044	#44 HOSE CLAMP	2
7U030-036	1/2" OIL DRAIN HOSE	2.5	7R002-072	#72 HOSE CLAMP	2
7R001-008	#8 HOSE CLAMP	2	7R003-016	ADEL CLAMP, 1.0"	1
7P375-017	3/8NPT X 1/2 BEADED HSE BRB	1	7R003-028	ADEL CLAMP, 2-3/8" .26 HOLE	2
4FU139-096	PCV MOD ASY	1	7R007-001	NYLON RATCHET CLAMP 1-1/8"	16
7P375-106	PCV VALVE, FORD, 3/8" HOSE	1	7S275-055	ELBOW, Ø.75 X 55° SILICONE	1
7P625-377	5/8" -3/8" REDUCER BARB UNION	1	7S450-200	SLEEVE, 4 1/2 X 2, BLUE	1
7R004-002	STEPLESS CLAMP, 17.0-70	2	7U030-046	5/32" VACUUM LINE	5
			7U030-065	3/4"X90° RUBBER HOSE, SHORT	1
			7U034-016	1" GS HEATER HOSE	1



ENGINEERING, LLC

2005-2006 Mustang GT, H.O. cont'd

Part No. 4FU218-020SQ

PARTS LIST

IMPORTANT: Before beginning installation, verify that all parts are included in the kit. Report any shortages or damaged parts immediately.

PART NO.	DESCRIPTION	QTY.
7U034-016	1" GS HEATER HOSE	1.25
7U038-000	3/4" HEATER HOSE	12
7U038-012	HOSE, 3/4" DIA 90°, 4X12 LEGS	1
7U038-020	HOSE, Ø3/4 'S' MOLDED RUBBER	1
7U038-150	HOSE, 3/4"X150" MOLDED HOSE	1
7U100-055	TIE WRAP, 7.5" NYLON	6
7U375-054	3/4" VINYL CAP	1
8D001-001	STD COMPRESS BYPASS VALVE	1
8F001-403	PUMP, WATER, BOSCH	1
8N010-160	SURGE TANK BRKT, MUST GT	1
8N010-220	MTG BRKT, 05-07 MUST BOSCH PMP	1
8N055-050	PLASTIC CAP, SURGE TANK	1
8N056-061	SURGE TANK INTEGRA GSR MODIFIE	1
8N106-135	WATER CLR ASY, MUST GEN.II	1
8N006-020	WATER COOLR, FLDYN DUAL PASS	1
8N010-171	BRACKET, DRVR SIDE CLR MNT,PLT	1
8N010-173	BRACKET, PASS SIDE CLR MNT	1
2A017-036	SPACER,PLT.BRG.HSG.,.0.186"	4
7C080-030	M8 X 1.25 X 30 HXHD CL10.9	6
7F008-020	NUT, M8 X 1.25	6
7J312-000	5/16 FLAT WASHER-SAE	12
7A250-051	1/4-20 X .50 HHCS ZINC PLTD	4
7J250-001	1/4 WASHER, SAE, PLTD	4
8N155-080	COOLANT RES RELOC, MUST	1
4FU010-051	MTG BRKT A, RES RELOC MUST	1
4FU010-061	BRKT B, COOL RES RELOC MUST	1
7A250-051	1/4-20 X .50 HHCS ZINC PLTD	4
7C060-020	M6 X 1.0 X 20MM HHCS ZN	3
7J006-093	6MM WASHER, PLATED	4
7J006-093	6MM WASHER, PLATED	3
7P250-045	1/4 MALE NPT X 3/8 MALE BARB	1
7P375-050	3/8" HOSE UNION, BRASS	1
7R002-010	#10 HOSE CLAMP	1
7R004-002	STEPLESS CLAMP, 17.0-70	3
7U030-056	3/8 PCV/VAC RUBBER HOSE	2.5
8N055-080	TANK, RAD OVERFLOW, MUST	1
008341	CHARGE COOLER DECAL	1



ENGINEERING, LLC

2005-2006 Mustang GT, H.O.

Part No. 4FU218-020L/028L

PARTS LIST

IMPORTANT: Before beginning installation, verify that all parts are included in the kit. Report any shortages or damaged parts immediately.

PART NO.	DESCRIPTION	QTY.	PART NUMBER	DESCRIPTION	QTY.
008110	SMALL SILVER DIE CUT DECAL	2	7J875-010	7/8 SEALING WASHER	1
008130	LICENSE PLATE FRAME	1	7F875-010	NUT, 7/8-14, SHORT/JAM	1
008341	CHARGE COOLER DECAL	1	7U133-050	1.5" X 90° HOSE, LONG LEG	1
008447	1 YR S/C WARRANTY PKG	1	7U133-190	HOSE, COOLNT DRIV SIDE 05 MUST	1
009035	S/C LUBE, BOTTLED, 3-PACK	1	7U038-000	3/4" HEATER HOSE	3.5
2F329-020	V3 SUPERCHARGER ASY, H.O.	1	7P375-075	3/4" HOSE BARB UNION, BRASS	1
4FU020-010	INSTR MAN 05-08 MUST GT	1	7R002-020	#20 HOSE CLAMP	4
4FU110-010	P/S RESERVOIR RELOCATION	1	7R002-024	#24 HOSE CLAMP	2
7P375-075	3/4" HOSE BARB UNION, BRASS	1	7P125-002	FREEZE PLUG, 1.25 DIA, .25 TAL	1
7P375-050	3/8" HOSE UNION, BRASS	1	7R002-010	#10 HOSE CLAMP	4
7R001-004	#4 HOSE CLAMP	2	7P125-016	1/8 NPT PLUG	1
7R001-008	#8 HOSE CLAMP	2	5A001-025	DIABLO MAFIA	1
7U038-030	HOSE, P/S, 3/4 ID	3	5A003-035	PREDATOR, 05-08 MUSTANG	1
7U032-016	3/8" EFI FUEL HSE HI-PSR	3	8F060-048	FUEL INJ, 39LB EV6, OEM 03 COB	8
7A250-075	1/4-20 X .75 SHCS PLTD	1	8F101-262	FUEL PMP ASY,05 MUST TWIN INTA	1
7J250-001	1/4 WASHER, SAE, PLTD	2	7U032-018	3/8" SUBMERSIBLE EFI FUEL HOSE	2.75
7F250-021	1/4-20 NYLOCK NUT ZINC PLATED	1	7U100-055	TIE WRAP, 7.5" NYLON	4
4FU010-010	P/S RELOC BRKT, 05 GT MUST	1	7R004-002	STEPLESS CLAMP, 17.0-70	2
7U100-055	TIE WRAP, 7.5" NYLON	4	8F001-255	255 INTANK FUEL PUMP '86-'97	1
4FU111-044	S/C MOUNTING BRKT ASY	1	7R002-044	#44 HOSE CLAMP	1
4FU010-044	S/C MOUNT PLT, MUST GT	1	7R004-006	STEPLESS CLAMP, 11.3 X 5MM WID	4
4FU010-034	IDLER MOUNT PLATE, MUST	1	5W001-022	T-TAP CONN,14-16 AWG	2
4FU017-011	SPACER, STUDDLED MUST GT	2	5W001-009	16-14GA MALE SLIDE INSULATED	2
2A017-750-05	SPACER, .750 OD X 2.691 LONG	2	5W001-080	FUSE, 20 AMP, MINI BLADE	1
2A017-750-06	SPACER, .750 OD X 2.712 LONG	1	7P375-099	Y-UNION, 3/8" BARBED TEFLON	1
2A017-879-08	SPACER, .875 OD X 1.776 LONG	1	7U032-025	HOSE, 5/16" ID,3/8"OD, 1/32" W	0.125
2A017-750-07	SPACER, .750 OD X .097 LONG	1	7U032-030	HOSE, SPIRAL 3/8" CUFF ID, 1' L	2
4FU017-021	SPACER, IDLER, MUST GT	1	8N101-290	WELDED CORE ASY	1
4PCS016-160	PULLEY, IDLER	1	8N104-125	SUPRT PCS, 05-08 MUST GT CLR G	1
2A046-120	BELT, GATES K061203	1	4FE014-010	RADIATOR PIPE-STAINLESS	1
7A375-375	3/8-16 X 3-3/4 HX HD	1	5W001-009	16-14GA MALE SLIDE INSULATED	1
7C080-150	M8 X 1.25 X 150MM HXHD CL10.9	1	5W001-011	16-14 GA RING TERM .26" HOLE	1
7C080-140	M8 X 1.25 X 140 HXHD CL8.8	2	5W001-015	FUSE, BLADE TYPE 20 AMP	1
7A375-100	3/8-16 X 1 G5 HHCS, PLT	7	5W001-022	T-TAP CONN,14-16 AWG	1
7K312-030	5/16 AN WASHER, S.S.	2	5W001-032	1/4" PLASTIC WIRE LOOM	60
7K375-040	3/8 AN960 FLAT WASHR PLATED	10	5W001-050	HARNES, FUEL INJ PLUG W/WIRES	1
4FU112-010	AIR INTAKE ASY	1	5W001-071	FUSE HOLDER,16GA WIRE	1
4FU012-010	INLET DUCT,"A"	1	5W018-010	18GA STRD WIRE RED	5
4FU012-015	INLET DUCT,"B"	1	7A250-050	1/4-20 X .50 SHCS ZINC PLTD	3
7R002-056	#56 HOSE CLAMP	1	7A250-051	1/4-20 X .50 HHCS ZINC PLTD	2
7S400-200	SLEEVE, 4 X 2, BLUE	2	7A250-074	1/4-20 X .75 HHCS PLTD	2
7S400-351	REDUCER SLV 4.00 X 3.5 X 2.35L	1	7F250-020	1/4-20 HEX NUT	2
7R002-064	#64 HOSE CLAMP	5	7J006-093	6MM WASHER, PLATED	5
8H040-235	AIR FILTER, 4.0FLG X 7.0L	1	7J250-001	1/4 WASHER, SAE, PLTD	4
8A003-071	MAF, 3.8 I.D. MUSTANG GT	1	7P156-082	5/32 TEE	1
7P750-102	3/4NPT X 1" X 90° HSE FIT	1	7P218-156	VAC TEE, 7/32,7/32,5/32	1
7P250-047	1/4NPT TO 3/8"BARB 90°	1	7P375-075	3/4" HOSE BARB UNION, BRASS	4
4FU010-071	BRKT, INTAKE SUPPORT	1	7P500-026	1/2NPT X 3/4 BARB 90° BRASS	2
7U032-016	3/8" EFI FUEL HSE HI-PSR	4	7P500-078	1/2NPT X 3/4 HOSE FIT STRT	2
4FU013-010	COVER, AIR FILTER, MUST GT	1	7R002-016	#16 HOSE CLAMP	4
7C040-008	M4-.7X8MM SCHED SS	2	7R002-024	#24 HOSE CLAMP	2
4FU114-010	RAD PIPE RELOC ASY, MUST GT	1	7R002-044	#44 HOSE CLAMP	2
4FU014-010	RADIATOR PIPE, 05 GT MUST	1	7R002-072	#72 HOSE CLAMP	2
7R002-024	#24 HOSE CLAMP	2	7R003-016	ADEL CLAMP, 1.0"	1
4FU139-096	PCV MOD ASY	1	7R003-028	ADEL CLAMP, 2-3/8" .26 HOLE	2
7P375-106	PCV VALVE, FORD, 3/8" HOSE	1	7R007-001	NYLON RATCHET CLAMP 1-1/8"	16
7P625-377	5/8" -3/8" REDUCER BARB UNION	1	7S275-055	ELBOW, Ø2.75 X 55° SILICONE	1
7R004-002	STEPLESS CLAMP, 17.0-70	2	7S450-200	SLEEVE, 4 1/2 X 2, BLUE	1
7R004-004	STEPLESS CLAMP, 1.0 OD HOSE	3	7U030-046	5/32" VACUUM LINE	5
7R004-007	STEPLESS CLAMP, 28.6 X 7MM WID	1	7U030-065	3/4"X90° RUBBER HOSE, SHORT	1
7U032-016	3/8" EFI FUEL HSE HI-PSR	0.25	7U034-016	1" GS HEATER HOSE	1
7U033-020	HOSE, 5/8"ID CLASS 1 EMISSIONS	0.66667	7U034-016	1" GS HEATER HOSE	1.25
4FU214-021	COOL BYP HOSE RELOC ASY	1	7U038-000	3/4" HEATER HOSE	12
4FU114-021	ASY, WATER OUTLET, 05 MUST GT	1	7U038-012	HOSE,3/4"DIA 90°,4X12 LEGS	1
			7U038-020	HOSE, Ø3/4 'S' MOLDED RUBBER	1
			7U038-150	HOSE, 3/4"X150° MOLDED HOSE	1



ENGINEERING, LLC

2005-2006 Mustang GT, H.O. cont'd

Part No. 4FU218-020L/028L

PARTS LIST

IMPORTANT: Before beginning installation, verify that all parts are included in the kit. Report any shortages or damaged parts immediately.

PART NO.	DESCRIPTION	QTY.
7U100-055	TIE WRAP, 7.5" NYLON	6
7U375-054	3/4" VINYL CAP	1
8D001-001	STD COMPRESS BYPASS VALVE	1
8F001-403	PUMP, WATER, BOSCH	1
8N010-160	SURGE TANK BRKT, MUST GT	1
8N010-220	MTG BRKT, 05-07 MUST BOSCH PMP	1
8N055-050	PLASTIC CAP, SURGE TANK	1
8N056-061	SURGE TANK INTEGRA GSR MODIFIE	1
8N106-135	WATER CLR ASY, MUST GEN.II	1
8N006-020	WATER COOLR, FLDYN DUAL PASS	1
8N010-171	BRACKET, DRVR SIDE CLR MNT,PLT	1
8N010-173	BRACKET, PASS SIDE CLR MNT	1
2A017-036	SPACER,PLT.BRG.HSG.,0.186"	4
7C080-030	M8 X 1.25 X 30 HXHD CL10.9	6
7F008-020	NUT, M8 X 1.25	6
7J312-000	5/16 FLAT WASHER-SAE	12
7A250-051	1/4-20 X .50 HHCS ZINC PLTD	4
7J250-001	1/4 WASHER, SAE, PLTD	4
8N155-080	COOLANT RES RELOC, MUST	1
4FU010-051	MTG BRKT A, RES RELOC MUST	1
4FU010-061	BRKT B, COOL RES RELOC MUST	1
7A250-051	1/4-20 X .50 HHCS ZINC PLTD	4
7C060-020	M6 X 1.0 X 20MM HHCS ZN	3
7J006-093	6MM WASHER, PLATED	4
7J006-093	6MM WASHER, PLATED	3
7P250-045	1/4 MALE NPT X 3/8 MALE BARB	1
7P375-050	3/8" HOSE UNION, BRASS	1
7R002-010	#10 HOSE CLAMP	1
7R004-002	STEPLESS CLAMP, 17.0-70	3
7U030-056	3/8 PCV/VAC RUBBER HOSE	2.5
8N055-080	TANK, RAD OVERFLOW, MUST	1

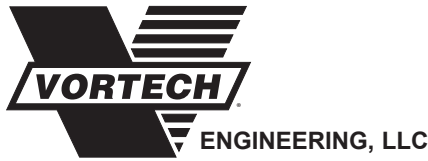

2007-2008 Mustang GT, Standard

Part No. 4FU218-030SQ/038SQ

PARTS LIST

IMPORTANT: Before beginning installation, verify that all parts are included in the kit. Report any shortages or damaged parts immediately.

PART NO.	DESCRIPTION	QTY.	PART NUMBER	DESCRIPTION	QTY.
2E229-230	V2-S SUPERCHARGER ASY	1	4FU114-030	WATER PIPE ASSY, 07-08 MUST GT	1
4FU130-036	OIL DRAIN ASSY	1	4FU014-051	HOUSING, THRMST RELC 07 MUST GT	1
7U030-036	1/2" OIL DRAIN HOSE	2.5	4FU014-060	WATER PIPE, Ø1.5 X 90°, 07 MUST	1
7R001-008	#8 HOSE CLAMP	2	5W001-085	SLEEVE, FLEX BRD Ø1.5" NOM.	0.83
7P375-017	3/8NPT X 1/2 BEADED HSE BRB	1	7C060-015	M6 X 1.0 X 16MM SHCS CL10.9+ Z	2
4FU130-026	OIL FEED ASY	1	7C060-020	M6 X 1.0 X 20MM HX	2
7U250-090-260	OIL FEED HOSE, 26" -4X90°	1	7J006-094	6MM WASHER S.S.	2
7P125-005	1/8 NPT STR. X -4 JIC FTG STL	1	7R002-024	#24 HOSE CLAMP	3
7P250-091	1/4 NPT 90° X -4JIC FTG STL	1	7U012-018	O-RING, 07 MUST GT THERM HSG	1
7P250-034	1/4 NPT X 1/4 NPT STRT T	1	8F101-262	FUEL PMP ASY,05 MUST TWIN INTA	1
4FU112-020	DISCHARGE ASY	1	7U032-018	3/8" SUBMERSIBLE EFI FUEL HOSE	2.75
4FU012-020	DUCT, DISCH, MUST GT STD	1	7U100-055	TIE WRAP, 7.5" NYLON	4
7S450-200	SLEEVE, 4 1/2 X 2, BLUE	1	7R004-002	STEPLESS CLAMP, 17.0-70	2
7S300-276	REDUCER, 3.0 X 2.75 X 2.5L	1	8F001-255	255 INTANK FUEL PUMP '86-'97	1
7R002-044	#44 HOSE CLAMP	1	7R002-044	#44 HOSE CLAMP	1
7R002-048	#48 HOSE CLAMP	1	7R004-006	STEPLESS CLAMP, 11.3 X 5MM WID	4
7R002-072	#72 HOSE CLAMP	2	5W001-022	T-TAP CONN, 14-16 AWG	2
7R002-016	#16 HOSE CLAMP	4	5W001-009	16-14GA MALE SLIDE INSULATED	2
7U030-046	5/32" VACUUM LINE	5	5W001-080	FUSE, 20 AMP. MINI BLADE	1
8D001-001	STD COMPRESS BYPASS VALVE	1	7P375-099	Y-UNION, 3/8" BARBED TEFLON	1
7U034-016	1" GS HEATER HOSE	1.25	7U032-025	HOSE, 5/16" ID, 3/8" OD, 1/32" W	0.125
7U034-016	1" GS HEATER HOSE	0.583	7U032-030	HOSE, SPIRAL 3/8" CUFF ID, 1" L	2
7P218-156	VAC TEE, 7/32, 7/32, 5/32	1	5A003-035	PREDATOR, 05-08 MUSTANG	1
4FU111-044	S/C MOUNTING BRKT ASY	1	4FU112-010	AIR INTAKE ASY	1
4FU010-044	S/C MOUNT PLT, MUST GT	1	4FU012-010	INLET DUCT,"A"	1
4FU010-034	IDLER MOUNT PLATE, MUST	1	4FU012-015	INLET DUCT,"B"	1
4FU017-011	SPACER, STUDDED MUST GT	2	7R002-056	#56 HOSE CLAMP	1
2A017-750-05	SPACER, .750 OD X 2.691 LONG	2	7S400-200	SLEEVE, 4 X 2, BLUE	2
2A017-750-06	SPACER, .750 OD X 2.712 LONG	1	7S400-351	REDUCER SLV 4.00 X 3.5 X 2.35L	1
2A017-879-08	SPACER, .875 OD X 1.776 LONG	1	7R002-064	#64 HOSE CLAMP	5
2A017-750-07	SPACER, .750 OD X .097 LONG	1	8H040-235	AIR FILTER, 4.0FLG X 7.0L	1
4FU017-021	SPACER, IDLER, MUST GT	1	8A003-071	MAF, 3.8 I.D. MUSTANG GT	1
4PCS016-160	PULLEY, IDLER	1	7P750-102	3/4NPT X 1" X 90° HSE FIT	1
2A046-120	BELT, GATES K061203	1	7P250-047	1/4NPT TO 3/8" BARB 90°	1
7A375-375	3/8-16 X 3-3/4 HX HD	1	4FU010-071	BRKT, INTAKE SUPPORT	1
7C080-150	M8 X 1.25 X 150MM HXHD CL10.9	1	7U032-016	3/8" EFI FUEL HSE HI-PSR	4
7C080-140	M8 X 1.25 X 140 HXHD CL8.8	2	4FU013-010	COVER, AIR FILTER, MUST GT	1
7A375-100	3/8-16 X 1 G5 HHCS, PLT	7	7C040-008	M4-.7X8MM SCHED SS	2
7K312-030	5/16 AN WASHER, S.S.	2	4FU101-001	MAF EXT MOD 05+ MUSTANG	1
7K375-040	3/8 AN960 FLAT WASHR PLATED	10	5W018-030	18GA STRD WIRE GREY	1
4FU110-010	P/S RESERVOIR RELOCATION	1	5W018-010	18GA STRD WIRE RED	1
7P375-075	3/4" HOSE BARB UNION, BRASS	1	5W018-020	18GA STRD WIRE BLK, UL1015	1
7P375-050	3/8" HOSE UNION, BRASS	1	5W018-080	18GA STRD WIRE BLUE BULK	1
7R001-004	#4 HOSE CLAMP	2	5W018-090	18GA STRD WIRE BROWN BULK	1
7R001-008	#8 HOSE CLAMP	2	5W018-100	18GA STRD WIRE PURPLE	1
7U038-030	HOSE, P/S, 3/4 ID	3	5W001-007	3/16" HEAT-SHRINK TUBING	1.5
7U032-016	3/8" EFI FUEL HSE HI-PSR	3	5W001-005	3/8" PLASTIC WIRE LOOM	1.5
7A250-075	1/4-20 X .75 SHCS PLTD	1	5W001-012	18-22 GA BUTT CONN RED INSUL	12
7J250-001	1/4 WASHER, SAE, PLTD	2			
7F250-021	1/4-20 NYLOCK NUT ZINC PLATED	1			
4FU010-010	P/S RELOC BRKT, 05 GT MUST	1			
7U100-055	TIE WRAP, 7.5" NYLON	4			
4FU139-096	PCV MOD ASY	1			
7P375-106	PCV VALVE, FORD, 3/8" HOSE	1			
7P625-377	5/8" -3/8" REDUCER BARB UNION	1			
7R004-002	STEPLESS CLAMP, 17.0-70	2			
7R004-004	STEPLESS CLAMP, 1.0 OD HOSE	3			
7R004-007	STEPLESS CLAMP, 28.6 X 7MM WID	1			
7U032-016	3/8" EFI FUEL HSE HI-PSR	0.25			
7U033-020	HOSE, 5/8" ID CLASS 1 EMISSIONS	0.6667			
8F060-048	FUEL INJ, 39LB EV6, OEM 03 COB	8			
008110	SMALL SILVER DIE CUT DECAL	2			
008444	3 YR S/C WARRANTY PKG	1			
008130	LICENSE PLATE FRAME, VORTECH	1			
4FU020-010	INSTR MAN 05-08 MUST GT	1			



ENGINEERING, LLC

2007-2008 Mustang GT, Standard

Part No. 4FU218-030L/038L

PARTS LIST

IMPORTANT: Before beginning installation, verify that all parts are included in the kit. Report any shortages or damaged parts immediately.

PART NO.	DESCRIPTION	QTY.	PART NUMBER	DESCRIPTION	QTY.
008110	SMALL SILVER DIE CUT DECAL	2	5W001-085	SLEEVE, FLEX BRD Ø1.5" NOM.	0.83
008130	LICENSE PLATE FRAME	1	7C060-015	M6 X 1.0 X 16MM SHCS CL10.9+ Z	2
008447	1 YR S/C WARRANTY PKG	1	7C060-020	M6 X 1.0 X 20MM HX	2
009035	S/C LUBE, BOTTLED, 3-PACK	1	7J006-094	6MM WASHER S.S.	2
2F329-010	V3 SUPERCHARGER ASY, STD	1	7R002-024	#24 HOSE CLAMP	3
4FU020-010	INSTR MAN 05-08 MUST GT	1	7U012-018	O-RING, 07 MUST GT THERM HSG	1
4FU110-010	P/S RESERVOIR RELOCATION	1	4FU139-096	PCV MOD ASY	1
7P375-075	3/4" HOSE BARB UNION, BRASS	1	7P375-106	PCV VALVE, FORD, 3/8" HOSE	1
7P375-050	3/8" HOSE UNION, BRASS	1	7P625-377	5/8" -3/8" REDUCER BARB UNION	1
7R001-004	#4 HOSE CLAMP	2	7R004-002	STEPLESS CLAMP, 17.0-70	2
7R001-008	#8 HOSE CLAMP	2	7R004-004	STEPLESS CLAMP, 1.0 OD HOSE	3
7U038-030	HOSE, P/S, 3/4 ID	3	7R004-007	STEPLESS CLAMP, 28.6 X 7MM WID	1
7U032-016	3/8" EFI FUEL HSE HI-PSR	3	7U032-016	3/8" EFI FUEL HSE HI-PSR	0.25
7A250-075	1/4-20 X .75 SHCS PLTD	1	7U033-020	HOSE, 5/8"ID CLASS 1 EMISSIONS	0.6667
7J250-001	1/4 WASHER, SAE, PLTD	2	5A003-035	PREDATOR, 05-08 MUSTANG	1
7F250-021	1/4-20 NYLOCK NUT ZINC PLATED	1	8F060-048	FUEL INJ, 39LB EV6, OEM 03 COB	8
4FU010-010	P/S RELOC BRKT, 05 GT MUST	1	8F101-262	FUEL PMP ASY,05 MUST TWIN INTA	1
7U100-055	TIE WRAP, 7.5" NYLON	4	7U032-018	3/8" SUBMERSIBLE EFI FUEL HOSE	2.75
4FU111-044	S/C MOUNTING BRKT ASY	1	7U100-055	TIE WRAP, 7.5" NYLON	4
4FU010-044	S/C MOUNT PLT, MUST GT	1	7R004-002	STEPLESS CLAMP, 17.0-70	2
4FU010-034	IDLER MOUNT PLATE, MUST	1	8F001-255	255 INTANK FUEL PUMP '86-'97	1
4FU017-011	SPACER, STUDDED MUST GT	2	7R002-044	#44 HOSE CLAMP	1
2A017-750-05	SPACER, .750 OD X 2.691 LONG	2	7R004-006	STEPLESS CLAMP, 11.3 X 5MM WID	4
2A017-750-06	SPACER, .750 OD X 2.712 LONG	1	5W001-022	T-TAP CONN,14-16 AWG	2
2A017-879-08	SPACER, .875 OD X 1.776 LONG	1	5W001-009	16-14GA MALE SLIDE INSULATED	2
2A017-750-07	SPACER, .750 OD X .097 LONG	1	5W001-080	FUSE, 20 AMP. MINI BLADE	1
4FU017-021	SPACER, IDLER, MUST GT	1	7P375-099	Y-UNION, 3/8" BARBED TEFLON	1
4PCS016-160	PULLEY, IDLER	1	7U032-025	HOSE, 5/16" ID,3/8"OD, 1/32" W	0.125
2A046-120	BELT, GATES K061203	1	7U032-030	HOSE, SPIRAL 3/8" CUFF ID, 1' L	2
7A375-375	3/8-16 X 3-3/4 HX HD	1	4FU101-001	MAF EXT MOD 05+ MUSTANG	1
7C080-150	M8 X 1.25 X 150MM HXHD CL10.9	1	5W018-030	18GA STRD WIRE GREY	1
7C080-140	M8 X 1.25 X 140 HXHD CL8.8	2	5W018-010	18GA STRD WIRE RED	1
7A375-100	3/8-16 X 1 G5 HHCS, PLT	7	5W018-020	18GA STRD WIRE BLK, UL1015	1
7K312-030	5/16 AN WASHER, S.S.	2	5W018-080	18GA STRD WIRE BLUE BULK	1
7K375-040	3/8 AN960 FLAT WASHR PLATED	10	5W018-090	18GA STRD WIRE BROWN BULK	1
4FU112-010	AIR INTAKE ASY	1	5W018-100	18GA STRD WIRE PURPLE	1
4FU012-010	INLET DUCT,"A"	1	5W001-007	3/16" HEAT-SHRINK TUBING	1.5
4FU012-015	INLET DUCT,"B"	1	5W001-005	3/8" PLASTIC WIRE LOOM	1.5
7R002-056	#56 HOSE CLAMP	1	5W001-012	18-22 GA BUTT CONN RED INSUL	12
7S400-200	SLEEVE, 4 X 2, BLUE	2			
7S400-351	REDUCER SLV 4.00 X 3.5 X 2.35L	1			
7R002-064	#64 HOSE CLAMP	5			
8H040-235	AIR FILTER, 4.0FLG X 7.0L	1			
8A003-071	MAF, 3.8 I.D. MUSTANG GT	1			
7P750-102	3/4NPT X 1" X 90° HSE FIT	1			
7P250-047	1/4NPT TO 3/8"BARB 90°	1			
4FU010-071	BRKT, INTAKE SUPPORT	1			
7U032-016	3/8" EFI FUEL HSE HI-PSR	4			
4FU013-010	COVER, AIR FILTER, MUST GT	1			
7C040-008	M4-.7X8MM SCHD SS	2			
4FU112-020	DISCHARGE ASY	1			
4FU012-020	DUCT, DISCH, MUST GT STD	1			
7S450-200	SLEEVE, 4 1/2 X 2, BLUE	1			
7S300-276	REDUCER, 3.0 X 2.75 X 2.5L	1			
7R002-044	#44 HOSE CLAMP	1			
7R002-048	#48 HOSE CLAMP	1			
7R002-072	#72 HOSE CLAMP	2			
7R002-016	#16 HOSE CLAMP	4			
7U030-046	5/32" VACUUM LINE	5			
8D001-001	STD COMPRESS BYPASS VALVE	1			
7U034-016	1" GS HEATER HOSE	1.25			
7U034-016	1" GS HEATER HOSE	0.583			
7P218-156	VAC TEE, 7/32,7/32,5/32	1			
4FU114-030	WATER PIPE ASSY, 07-08 MUST GT	1			
4FU014-051	HOUSING, THRMST RELC 07 MUST G	1			
4FU014-060	WATER PIPE, Ø1.5 X 90°,07 MUST	1			

P/N: 4FU020-010 v6.2, 06-08-10
 ©2010 Vortech Engineering, LLC
 All Rights Reserved, Intl. Corp. Secured

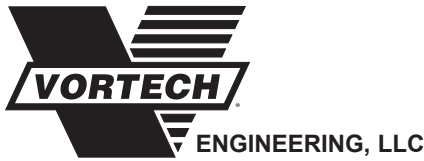

2007-2008 Mustang GT, H.O.

Part No. 4FU218-040SQ/048SQ

PARTS LIST

IMPORTANT: Before beginning installation, verify that all parts are included in the kit. Report any shortages or damaged parts immediately.

PART NO.	DESCRIPTION	QTY.	PART NUMBER	DESCRIPTION	QTY.
008110	SMALL SILVER DIE CUT DECAL	2	7U030-036	1/2" OIL DRAIN HOSE	2.5
008130	LICENSE PLATE FRAME	1	7R001-008	#8 HOSE CLAMP	2
008444	3 YR S/C WARRANTY PKG	1	7P375-017	3/8NPT X 1/2 BEADED HSE BRB	1
2E229-240	V2-S SUPERCHARGER ASY, H.O.	1	4FU139-096	PCV MOD ASY	1
4FU020-010	INSTR MAN 05-08 MUST GT	1	7P375-106	PCV VALVE, FORD, 3/8" HOSE	1
4FU110-010	P/S RESERVOIR RELOCATION	1	7P625-377	5/8" -3/8" REDUCER BARB UNION	1
7P375-075	3/4" HOSE BARB UNION, BRASS	1	7R004-002	STEPLESS CLAMP, 17.0-70	2
7P375-050	3/8" HOSE UNION, BRASS	1	7R004-004	STEPLESS CLAMP, 1.0 OD HOSE	3
7R001-004	#4 HOSE CLAMP	2	7R004-007	STEPLESS CLAMP, 28.6 X 7MM WID	1
7R001-008	#8 HOSE CLAMP	2	7U032-016	3/8" EFI FUEL HSE HI-PSR	0.25
7U038-030	HOSE, P/S, 3/4 ID	3	7U033-020	HOSE, 5/8"ID CLASS 1 EMISSIONS	0.6667
7U032-016	3/8" EFI FUEL HSE HI-PSR	3	5A001-025	DIABLO MAFIA	1
7A250-075	1/4-20 X .75 SHCS PLTD	1	5A003-035	PREDATOR, 05-08 MUSTANG	1
7J250-001	1/4 WASHER, SAE, PLTD	2	8F060-048	FUEL INJ, 39LB EV6, OEM 03 COB	8
7F250-021	1/4-20 NYLOCK NUT ZINC PLATED	1	8F101-262	FUEL PMP ASY,05 MUST TWIN INTA	1
4FU010-010	P/S RELOC BRKT, 05 GT MUST	1	7U032-018	3/8" SUBMERSIBLE EFI FUEL HOSE	2.75
7U100-055	TIE WRAP, 7.5" NYLON	4	7U100-055	TIE WRAP, 7.5" NYLON	4
4FU111-044	S/C MOUNTING BRKT ASY	1	7R004-002	STEPLESS CLAMP, 17.0-70	2
4FU010-044	S/C MOUNT PLT, MUST GT	1	8F001-255	255 INTANK FUEL PUMP '86-'97	1
4FU010-034	IDLER MOUNT PLATE, MUST	1	7R002-044	#44 HOSE CLAMP	1
4FU017-011	SPACER, STUDDED MUST GT	2	7R004-006	STEPLESS CLAMP, 11.3 X 5MM WID	4
2A017-750-05	SPACER, .750 OD X 2.691 LONG	2	5W001-022	T-TAP CONN,14-16 AWG	2
2A017-750-06	SPACER, .750 OD X 2.712 LONG	2	5W001-009	16-14GA MALE SLIDE INSULATED	2
2A017-879-08	SPACER, .875 OD X 1.776 LONG	1	5W001-080	FUSE, 20 AMP. MINI BLADE	1
2A017-750-07	SPACER, .750 OD X .097 LONG	1	7P375-099	Y-UNION, 3/8" BARBED TEFLON	1
4FU017-021	SPACER, IDLER, MUST GT	1	7U032-025	HOSE, 5/16" ID, 3/8"OD, 1/32" W	0.125
4PCS016-160	PULLEY, IDLER	1	7U032-030	HOSE, SPIRAL 3/8" CUFF ID, 1' L	2
2A046-120	BELT, GATES K061203	1	8N101-290	WELDED CORE ASY	1
7A375-375	3/8-16 X 3-3/4 HX HD	1	8N104-125	SUPRT PCS, 05-08 MUST GT CLR G	1
7C080-150	M8 X 1.25 X 150MM HXHD CL10.9	1	4FE014-010	RADIATOR PIPE-STAINLESS	1
7C080-140	M8 X 1.25 X 140 HXHD CL8.8	2	5W001-009	16-14GA MALE SLIDE INSULATED	1
7A375-100	3/8-16 X 1 G5 HHCS, PLT	7	5W001-011	16-14 GA RING TERM .26" HOLE	1
7K312-030	5/16 AN WASHER, S.S.	2	5W001-015	FUSE, BLADE TYPE 20 AMP	1
7K375-040	3/8 AN960 FLAT WASHR PLATED	10	5W001-022	T-TAP CONN,14-16 AWG	1
4FU112-010	AIR INTAKE ASY	1	5W001-032	1/4" PLASTIC WIRE LOOM	60
4FU012-010	INLET DUCT,"A"	1	5W001-050	HARNES, FUEL INJ PLUG W/WIRES	1
4FU012-015	INLET DUCT,"B"	1	5W001-071	FUSE HOLDER,16GA WIRE	1
7R002-056	#56 HOSE CLAMP	1	5W018-010	18GA STRD WIRE RED	5
7S400-200	SLEEVE, 4 X 2, BLUE	2	7A250-050	1/4-20 X .50 SHCS ZINC PLTD	3
7S400-351	REDUCER SLV 4.00 X 3.5 X 2.35L	1	7A250-051	1/4-20 X .50 HHCS ZINC PLTD	2
7R002-064	#64 HOSE CLAMP	5	7A250-074	1/4-20 X .75 HHCS PLTD	2
8H040-235	AIR FILTER, 4.0FLG X 7.0L	1	7F250-020	1/4-20 HEX NUT	2
8A003-071	MAF, 3.8 I.D. MUSTANG GT	1	7J006-093	6MM WASHER, PLATED	5
7P750-102	3/4NPT X 1" X 90° HSE FIT	1	7J250-001	1/4 WASHER, SAE, PLTD	4
7P250-047	1/4NPT TO 3/8"BARB 90°	1	7P156-082	5/32 TEE	1
4FU010-071	BRKT, INTAKE SUPPORT	1	7P218-156	VAC TEE, 7/32,7/32,5/32	1
7U032-016	3/8" EFI FUEL HSE HI-PSR	4	7P375-075	3/4" HOSE BARB UNION, BRASS	4
4FU013-010	COVER, AIR FILTER, MUST GT	1	7P500-026	1/2NPT X 3/4 BARB 90° BRASS	2
7C040-008	M4-.7X8MM SCHD SS	2	7P500-078	1/2NPT X 3/4 HOSE FIT STRT	2
4FU114-030	WATER PIPE ASSY, 07-08 MUST GT	1	7R002-016	#16 HOSE CLAMP	4
4FU014-051	HOUSING, THRMST RELC 07 MUST G	1	7R002-024	#24 HOSE CLAMP	2
4FU014-060	WATER PIPE, Ø1.5 X 90°,07 MUST	1	7R002-044	#44 HOSE CLAMP	2
5W001-085	SLEEVE, FLEX BRD Ø1.5" NOM.	0.83	7R002-072	#72 HOSE CLAMP	2
7C060-015	M6 X 1.0 X 16MM SHCS CL10.9+ Z	2	7R003-016	ADEL CLAMP, 1.0"	1
7C060-020	M6 X 1.0 X 20MM HX	2	7R003-028	ADEL CLAMP, 2-3/8" .26 HOLE	2
7J006-094	6MM WASHER S.S.	2	7R007-001	NYLON RATCHET CLAMP 1-1/8"	16
7R002-024	#24 HOSE CLAMP	3	7S275-055	ELBOW, Ø2.75 X 55° SILICONE	1
7U012-018	O-RING, 07 MUST GT THERM HSG	1	7S450-200	SLEEVE, 4 1/2 X 2, BLUE	1
4FU130-026	OIL FEED ASY	1	7U030-046	5/32" VACUUM LINE	5
7U250-090-260	OIL FEED HOSE, 26" -4X90°	1	7U030-065	3/4"X90° RUBBER HOSE, SHORT	1
7P125-005	1/8 NPT STR. X -4 JIC FTG STL	1	7U034-016	1" GS HEATER HOSE	1
7P250-091	1/4 NPT 90° X -4JIC FTG STL	1	7U034-016	1" GS HEATER HOSE	1.25
7P250-034	1/4 NPT X 1/4 NPT STRT T	1	7U038-000	3/4" HEATER HOSE	12
4FU130-036	OIL DRAIN ASSY	1	7U038-012	HOSE,3/4"DIA 90°,4X12 LEGS	1
			7U038-020	HOSE, Ø3/4 'S' MOLDED RUBBER	1



ENGINEERING, LLC

2007-2008 Mustang GT, H.O. cont'd

Part No. 4FU218-040SQ/048SQ

PARTS LIST

IMPORTANT: Before beginning installation, verify that all parts are included in the kit. Report any shortages or damaged parts immediately.

PART NO.	DESCRIPTION	QTY.
7U038-150	HOSE, 3/4"X150° MOLDED HOSE	1
7U100-055	TIE WRAP, 7.5" NYLON	6
7U375-054	3/4" VINYL CAP	1
8D001-001	STD COMPRESS BYPASS VALVE	1
8F001-403	PUMP, WATER, BOSCH	1
8N010-160	SURGE TANK BRKT, MUST GT	1
8N010-220	MTG BRKT, 05-07 MUST BOSCH PMP	1
8N055-050	PLASTIC CAP, SURGE TANK	1
8N056-061	SURGE TANK INTEGRA GSR MODIFIE	1
8N106-135	WATER CLR ASY, MUST GEN.II	1
8N006-020	WATER COOLR, FLDYN DUAL PASS	1
8N010-171	BRACKET, DRVR SIDE CLR MNT,PLT	1
8N010-173	BRACKET, PASS SIDE CLR MNT	1
2A017-036	SPACER,PLT.BRG.HSG.,0.186"	4
7C080-030	M8 X 1.25 X 30 HXHD CL10.9	6
7F008-020	NUT, M8 X 1.25	6
7J312-000	5/16 FLAT WASHER-SAE	12
7A250-051	1/4-20 X .50 HHCS ZINC PLTD	4
7J250-001	1/4 WASHER, SAE, PLTD	4
8N155-082	COOLANT RES RELOC, 07-08 MUST	1
4FU010-061	BRKT B, COOL RES RELOC MUST	1
4FU010-091	BRKT, COOL RES RELOC, 07 GT	1
7A250-051	1/4-20 X .50 HHCS ZINC PLTD	4
7A250-074	1/4-20 X .75 HHCS PLTD	3
7F250-021	1/4-20 NYLOCK NUT ZINC PLATED	3
7J006-093	6MM WASHER, PLATED	10
7P100-076	HOSE REDUCER, 1"->3/4" PLSTC	1
7P250-045	1/4 MALE NPT X 3/8 MALE BARB	1
7P375-050	3/8" HOSE UNION, BRASS	1
7R002-010	#10 HOSE CLAMP	2
7R004-002	STEPLESS CLAMP, 17.0-70	3
7U030-056	3/8 PCV/VAC RUBBER HOSE	2.5
7U038-000	3/4" HEATER HOSE	1.83
8N055-080	TANK, RAD OVERFLOW, MUST	1
008341	VORTECH CHARGE COOLER DECAL	1

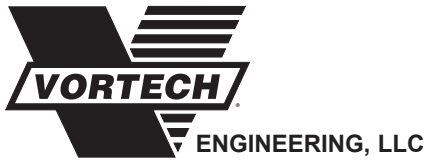

2007-2008 Mustang GT, H.O.

Part No. 4FU218-040L/048L

PARTS LIST

IMPORTANT: Before beginning installation, verify that all parts are included in the kit. Report any shortages or damaged parts immediately.

PART NO.	DESCRIPTION	QTY.	PART NUMBER	DESCRIPTION	QTY.
008110	SMALL SILVER DIE CUT DECAL	2	4FU139-096	PCV MOD ASY	1
008130	LICENSE PLATE FRAME, VORTECH	1	7P375-106	PCV VALVE, FORD, 3/8" HOSE	1
008341	VORTECH CHARGE COOLER DECAL	1	7P625-377	5/8" -3/8" REDUCER BARB UNION	1
008447	1 YR S/C WARRANTY PKG	1	7R004-002	STEPLESS CLAMP, 17.0-70	2
009035	S/C LUBE, BOTTLED, VORT 3-PACK	1	7R004-004	STEPLESS CLAMP, 1.0 OD HOSE	3
2F329-020	V3 SUPERCHARGER ASY, H.O.	1	7R004-007	STEPLESS CLAMP, 28.6 X 7MM WID	1
4FU020-010	INSTR MAN 05-08 MUST GT	1	7U032-016	3/8" EFI FUEL HSE HI-PSR	0.25
4FU110-010	P/S RESERVOIR RELOCATION	1	7U033-020	HOSE, 5/8"ID CLASS 1 EMISSIONS	0.6667
7P375-075	3/4" HOSE BARB UNION, BRASS	1	5A001-025	DIABLO MAFIA	1
7P375-050	3/8" HOSE UNION, BRASS	1	5A003-035	PREDATOR, 05-08 MUSTANG	1
7R001-004	#4 HOSE CLAMP	2	8F060-048	FUEL INJ, 39LB EV6, OEM 03 COB	8
7R001-008	#8 HOSE CLAMP	2	8F101-262	FUEL PMP ASY,05 MUST TWIN INTA	1
7U038-030	HOSE, P/S, 3/4 ID	3	7U032-018	3/8" SUBMERSIBLE EFI FUEL HOSE	2.75
7U032-016	3/8" EFI FUEL HSE HI-PSR	3	7U100-055	TIE WRAP, 7.5" NYLON	4
7A250-075	1/4-20 X .75 SHCS PLTD	1	7R004-002	STEPLESS CLAMP, 17.0-70	2
7J250-001	1/4 WASHER, SAE, PLTD	2	8F001-255	255 INTANK FUEL PUMP '86-'97	1
7F250-021	1/4-20 NYLOCK NUT ZINC PLATED	1	7R002-044	#44 HOSE CLAMP	1
4FU010-010	P/S RELOC BRKT, 05 GT MUST	1	7R004-006	STEPLESS CLAMP, 11.3 X 5MM WID	4
7U100-055	TIE WRAP, 7.5" NYLON	4	5W001-022	T-TAP CONN,14-16 AWG	2
4FU111-044	S/C MOUNTING BRKT ASY	1	5W001-009	16-14GA MALE SLIDE INSULATED	2
4FU010-044	S/C MOUNT PLT, MUST GT	1	5W001-080	FUSE, 20 AMP, MINI BLADE	1
4FU010-034	IDLER MOUNT PLATE, MUST	1	7P375-099	Y-UNION, 3/8" BARBED TEFLON	1
4FU017-011	SPACER, STUDDED MUST GT	2	7U032-025	HOSE, 5/16" ID,3/8"OD, 1/32" W	0.125
2A017-750-05	SPACER, .750 OD X 2.691 LONG	2	7U032-030	HOSE, SPIRAL 3/8" CUFF ID, 1' L	2
2A017-750-06	SPACER, .750 OD X 2.712 LONG	1	8N101-290	WELDED CORE ASY	1
2A017-879-08	SPACER, .875 OD X 1.776 LONG	1	8N104-125	SUPRT PCS, 05-08 MUST GT CLR G	1
2A017-750-07	SPACER, .750 OD X .097 LONG	1	4FE014-010	RADIATOR PIPE-STAINLESS	1
4FU017-021	SPACER, IDLER, MUST GT	1	5W001-009	16-14GA MALE SLIDE INSULATED	1
4PCS016-160	PULLEY, IDLER	1	5W001-011	16-14 GA RING TERM .26" HOLE	1
2A046-120	BELT, GATES K061203	1	5W001-015	FUSE, BLADE TYPE 20 AMP	1
7A375-375	3/8-16 X 3-3/4 HX HD	1	5W001-022	T-TAP CONN,14-16 AWG	1
7C080-150	M8 X 1.25 X 150MM HXHD CL10.9	1	5W001-032	1/4" PLASTIC WIRE LOOM	60
7C080-140	M8 X 1.25 X 140 HXHD CL8.8	2	5W001-050	HARNASS, FUEL INJ PLUG W/WIRES	1
7A375-100	3/8-16 X 1 G5 HHCS, PLT	7	5W001-071	FUSE HOLDER,16GA WIRE	1
7K312-030	5/16 AN WASHER, S.S.	2	5W018-010	18GA STRD WIRE RED	5
7K375-040	3/8 AN960 FLAT WASHR PLATED	10	7A250-050	1/4-20 X .50 SHCS ZINC PLTD	3
4FU112-010	AIR INTAKE ASY	1	7A250-051	1/4-20 X .50 HHCS ZINC PLTD	2
4FU012-010	INLET DUCT,"A"	1	7A250-074	1/4-20 X .75 HHCS PLTD	2
4FU012-015	INLET DUCT,"B"	1	7F250-020	1/4-20 HEX NUT	2
7R002-056	#56 HOSE CLAMP	1	7J006-093	6MM WASHER, PLATED	5
7S400-200	SLEEVE, 4 X 2, BLUE	2	7J250-001	1/4 WASHER, SAE, PLTD	4
7S400-351	REDUCER SLV 4.00 X 3.5 X 2.35L	1	7P156-082	5/32 TEE	1
7R002-064	#64 HOSE CLAMP	5	7P218-156	VAC TEE, 7/32,7/32,5/32	1
8H040-235	AIR FILTER, 4.0FLG X 7.0L	1	7P375-075	3/4" HOSE BARB UNION, BRASS	4
8A003-071	MAF, 3.8 I.D. MUSTANG GT	1	7P500-026	1/2NPT X 3/4 BARB 90° BRASS	2
7P750-102	3/4NPT X 1" X 90° HSE FIT	1	7P500-078	1/2NPT X 3/4 HOSE FIT STRT	2
7P250-047	1/4NPT TO 3/8"BARB 90°	1	7R002-016	#16 HOSE CLAMP	4
4FU010-071	BRKT, INTAKE SUPPORT	1	7R002-024	#24 HOSE CLAMP	2
7U032-016	3/8" EFI FUEL HSE HI-PSR	4	7R002-044	#44 HOSE CLAMP	2
4FU013-010	COVER, AIR FILTER, MUST GT	1	7R002-072	#72 HOSE CLAMP	2
7C040-008	M4-.7X8MM SCHD SS	2	7R003-016	ADEL CLAMP, 1.0"	1
4FU114-030	WATER PIPE ASSY, 07-08 MUST GT	1	7R003-028	ADEL CLAMP, 2-3/8" .26 HOLE	2
4FU014-051	HOUSING, THRMST RELC 07 MUST G	1	7R007-001	NYLON RATCHET CLAMP 1-1/8"	16
4FU014-060	WATER PIPE, Ø1.5 X 90°,07 MUST	1	7S275-055	ELBOW, Ø2.75 X 55° SILICONE	1
5W001-085	SLEEVE, FLEX BRD Ø1.5" NOM.	0.83	7S450-200	SLEEVE, 4 1/2 X 2, BLUE	1
7C060-015	M6 X 1.0 X 16MM SHCS CL10.9+ Z	2	7U030-046	5/32" VACUUM LINE	5
7C060-020	M6 X 1.0 X 20MM HX	2	7U030-065	3/4"X90° RUBBER HOSE, SHORT	1
7J006-094	6MM WASHER S.S.	2	7U034-016	1" GS HEATER HOSE	1
7R002-024	#24 HOSE CLAMP	3	7U034-016	1" GS HEATER HOSE	1.25
7U012-018	O-RING, 07 MUST GT THERM HSG	1	7U038-000	3/4" HEATER HOSE	12
			7U038-012	HOSE,3/4"DIA 90°,4X12 LEGS	1
			7U038-020	HOSE, Ø3/4 'S' MOLDED RUBBER	1



ENGINEERING, LLC

2007-2008 Mustang GT, H.O. cont'd

Part No. 4FU218-040L/048L

PARTS LIST

IMPORTANT: Before beginning installation, verify that all parts are included in the kit. Report any shortages or damaged parts immediately.

PART NO.	DESCRIPTION	QTY.	PART NUMBER	DESCRIPTION	QTY.
7U038-150	HOSE, 3/4"X150° MOLDED HOSE	1			
7U100-055	TIE WRAP, 7.5" NYLON	6			
7U375-054	3/4" VINYL CAP	1			
8D001-001	STD COMPRESS BYPASS VALVE	1			
8F001-403	PUMP, WATER, BOSCH	1			
8N010-160	SURGE TANK BRKT, MUST GT	1			
8N010-220	MTG BRKT, 05-07 MUST BOSCH PMP	1			
8N055-050	PLASTIC CAP, SURGE TANK	1			
8N056-061	SURGE TANK INTEGRA GSR MODIFIE	1			
8N106-135	WATER CLR ASY, MUST GEN.II	1			
8N006-020	WATER COOLR, FLDYN DUAL PASS	1			
8N010-171	BRACKET, DRVR SIDE CLR MNT,PLT	1			
8N010-173	BRACKET, PASS SIDE CLR MNT	1			
2A017-036	SPACER,PLT.BRG.HSG.,0.186"	4			
7C080-030	M8 X 1.25 X 30 HXHD CL10.9	6			
7F008-020	NUT, M8 X 1.25	6			
7J312-000	5/16 FLAT WASHER-SAE	12			
7A250-051	1/4-20 X .50 HHCS ZINC PLTD	4			
7J250-001	1/4 WASHER, SAE, PLTD	4			
8N155-082	COOLANT RES RELOC, 07-08 MUST	1			
4FU010-061	BRKT B, COOL RES RELOC MUST	1			
4FU010-091	BRKT, COOL RES RELOC, 07 GT	1			
7A250-051	1/4-20 X .50 HHCS ZINC PLTD	4			
7A250-074	1/4-20 X .75 HHCS PLTD	3			
7F250-021	1/4-20 NYLOCK NUT ZINC PLATED	3			
7J006-093	6MM WASHER, PLATED	10			
7P100-076	HOSE REDUCER, 1"->3/4" PLSTC	1			
7P250-045	1/4 MALE NPT X 3/8 MALE BARB	1			
7P375-050	3/8" HOSE UNION, BRASS	1			
7R002-010	#10 HOSE CLAMP	2			
7R004-002	STEPLESS CLAMP, 17.0-70	3			
7U030-056	3/8 PCV/VAC RUBBER HOSE	2.5			
7U038-000	3/4" HEATER HOSE	1.83			
8N055-080	TANK, RAD OVERFLOW, MUST	1			



ENGINEERING, LLC

2008 Mustang Bullitt

Part No. 4FU218-050L/058L

PARTS LIST

IMPORTANT: Before beginning installation, verify that all parts are included in the kit. Report any shortages or damaged parts immediately.

PART NO.	DESCRIPTION	QTY.	PART NUMBER	DESCRIPTION	QTY.
2F329-070	V3 SUPERCHARGER ASY	1	7C040-008	M4-.7X8MM SCHD SS	2
008110	SMALL SILVER DIE CUT DECAL	2	4FU114-030	WATER PIPE ASSY, 07-08 MUST GT	1
008130	LICENSE PLATE FRAME	1	4FU014-051	HOUSING, THRMST RELC 07 MUST G	1
008341	CHARGE COOLER DECAL	1	4FU014-060	WATER PIPE, Ø1.5 X 90°, 07 MUST	1
008447	1 YR S/C WARRANTY PKG	1	5W001-085	SLEEVE, FLEX BRD Ø1.5" NOM.	0.83
009035	S/C LUBE, BOTTLED, 3-PACK	1	7C060-015	M6 X 1.0 X 16MM SHCS CL10.9+ Z	2
4FU020-010	INSTR MAN 05-08 MUST GT	1	7C060-020	M6 X 1.0 X 20MM HX	2
4FU110-010	P/S RESERV RELOC MUST GT	1	7J006-094	6MM WASHER S.S.	2
7P375-075	3/4" HOSE BARB UNION, BRASS	1	7R002-024	#24 HOSE CLAMP	3
7P375-050	3/8" HOSE UNION, BRASS	1	7U012-018	O-RING, 07 MUST GT THERM HSG	1
7R001-004	#4 HOSE CLAMP	2	4FU139-096	PCV MOD ASSY, 05 GT	1
7R001-008	#8 HOSE CLAMP	2	7P375-106	PCV VALVE, FORD, 3/8" HOSE	1
7U038-030	HOSE, P/S, 3/4 ID	3	7P625-377	5/8" -3/8" REDUCER BARB UNION	1
7U032-016	3/8" EFI FUEL HSE HI-PSR	3	7R004-002	STEPLESS CLAMP, 17.0-70	2
7A250-075	1/4-20 X .75 SHCS PLTD	1	7R004-004	STEPLESS CLAMP, 1.0 OD HOSE	3
7J250-001	1/4 WASHER, SAE, PLTD	2	7R004-007	STEPLESS CLAMP, 28.6 X 7MM WID	1
7F250-021	1/4-20 NYLOCK NUT ZINC PLATED	1	7U032-016	3/8" EFI FUEL HSE HI-PSR	0.25
4FU010-010	P/S RELOC BRKT	1	7U033-020	HOSE, 5/8"ID CLASS 1 EMISSIONS	0.6667
7U100-055	TIE WRAP, 7.5" NYLON	4	5A001-025	DIABLO MAFIA, MUST	1
4FU111-051	S/C MTG BRKT ASSY, V-PWR	1	5A003-035	PREDATOR, 05-08 MUSTANG	1
4FU010-044	S/C MOUNT PLT	1	8F060-061	FUEL INJ. 60 LB LONG, US CAR,	8
4FU010-034	IDLER MOUNT PLATE	1	8F101-262	FUEL PMP ASY,05 MUST TWIN INTA	1
4FU017-041	SPCR, STD BLT BRNG PLT 1.597"	2	7U032-018	3/8" SUBMERSIBLE EFI FUEL HOSE	2.75
2A017-750-05	SPACER, .750 OD X 2.691 LONG	2	7U100-055	TIE WRAP, 7.5" NYLON	4
2A017-750-06	SPACER, .750 OD X 2.712 LONG	2	7R004-002	STEPLESS CLAMP, 17.0-70	2
2A017-879-07	SPACER, .875 OD X 1.597 LNG	1	8F001-255	255 INTANK FUEL PUMP '86-'97	1
2A017-750-07	SPACER, .750 OD X .097 LONG	1	7R002-044	#44 HOSE CLAMP	1
4FU017-031	SPACER, IDLR 1OD X .375 ID X .	1	7R004-006	STEPLESS CLAMP, 11.3 X 5MM WID	4
4FU016-021	PULLEY, IDLR 3.5" 8-RIB (SMOOT	1	5W001-022	T-TAP CONN, 14-16 AWG	2
2A048-121	BELT, DAYCO-5081213, 8-RIB	1	5W001-009	16-14GA MALE SLIDE INSULATED	2
7A375-375	3/8-16 X 3-3/4 HX HD	1	5W001-080	FUSE, 20 AMP. MINI BLADE	1
7C080-150	M8 X 1.25 X 150MM HXHD CL10.9	1	7P375-099	Y-UNION, 3/8" BARBED TEFLON	1
7C080-140	M8 X 1.25 X 140 HXHD CL8.8	2	7U032-025	HOSE, 5/16" ID, 3/8"OD, 1/32" W	0.125
7A375-100	3/8-16 X 1 G5 HHCS, PLT	2	7U032-030	HOSE, SPIRAL 3/8" CUFF ID, 1' L	2
7A375-124	3/8-16 X 1-1/4 HHCS, G5, PLATE	5	8N104-160	SUPPORT PCS, LG, 05+ MUST GT V	1
2A017-878-08	SPACER, .875OD X .406 ID X .280	5	4FE014-010	RADIATOR PIPE-STAINLESS	1
7K312-030	5/16 AN WASHER, S.S.	2	5W001-009	16-14GA MALE SLIDE INSULATED	1
7K375-040	3/8 AN960 FLAT WASHR PLATED	10	5W001-011	16-14 GA RING TERM .26" HOLE	1
4FR016-021	PULLEY, 8 RIB A/C PLY 03 COBRA	1	5W001-015	FUSE, BLADE TYPE 20 AMP	1
4FR016-031	PULLEY, 8 RIB P/S 03 COBRA	1	5W001-022	T-TAP CONN, 14-16 AWG	1
4FR016-041	DAMPER, CRANK, 8 RIB 03 COBRA	1	5W001-032	1/4" PLASTIC WIRE LOOM	60
4FU016-011	PULLEY, FORD, ALT, 8-RIB, 2.5" OD	1	5W001-050	HARNES, FUEL INJ PLUG W/WIRES	1
7G016-150	NUT, M16 X 1.50 FLANGED	1	5W001-071	FUSE HOLDER, 16GA WIRE	1
4FU016-021	PULLEY, IDLR 3.5" 8-RIB (SMOOT	2	5W018-010	18GA STRD WIRE RED	5
4FU016-041	PULLEY, IDLR 3.5" 8-RIB (RIBD)	1	7A250-050	1/4-20 X .50 SHCS ZINC PLTD	3
2A017-882-02	SPACER, .875 OD X .101 LNG	3	7A250-051	1/4-20 X .50 HHCS ZINC PLTD	2
2A017-750-014	SPACER .75"OD X .328"ID X .140"	3	7A250-074	1/4-20 X .75 HHCS PLTD	2
7C080-041	M8 X 1.25 X 40 HXHD ZINC	3	7F250-020	1/4-20 HEX NUT	2
7J312-000	5/16 FLAT WASHER-SAE	3	7J006-093	6MM WASHER, PLATED	5
4FU116-031	IDLER ASSY, 3" 8-RIB (SMOOTH)	1	7J250-001	1/4 WASHER, SAE, PLTD	4
4FU112-010	AIR INLET ASSY, 05 MUST GT	1	7P156-082	5/32 TEE	1
4FU012-010	INLET DUCT,"A"	1	7P175-100	COMP BYPASS "Y", 1.75 X 1.00	1
4FU012-015	INLET DUCT,"B"	1	7P218-156	VAC TEE, 7/32, 7/32, 5/32	1
7R002-056	#56 HOSE CLAMP	1	7P375-075	3/4" HOSE BARB UNION, BRASS	4
7S400-200	SLEEVE, 4 X 2, BLUE	2	7P500-026	1/2NPT X 3/4 BARB 90° BRASS	3
7S400-351	REDUCER SLV 4.00 X 3.5 X 2.35L	1	7P500-078	1/2NPT X 3/4 HOSE FIT STRT	1
7R002-064	#64 HOSE CLAMP	5	7P750-102	3/4NPT X 1" X 90° HSE FIT	1
8H040-235	AIR FILTER, 4.0FLG X 7.0L	1	7R002-016	#16 HOSE CLAMP	10
8A003-071	MAF, 3.8 I.D., 05 MUSTANG GT,	1	7R002-024	#24 HOSE CLAMP	2
7P750-102	3/4NPT X 1" X 90° HSE FIT	1	7R002-028	#28 HOSE CLAMP	2
7P250-047	1/4NPT TO 3/8" BARB 90°	1	7R002-044	#44 HOSE CLAMP	1
4FU010-071	BRKT, INTAKE SUPPORT	1	7R002-048	#48 HOSE CLAMP	1
7U032-016	3/8" EFI FUEL HSE HI-PSR	4	7R002-072	#72 HOSE CLAMP	2
4FU013-010	COVER, AIR FILTER, MUST GT	1	7R003-016	ADEL CLAMP, 1.0"	1
			7R003-028	ADEL CLAMP, 2-3/8" .26 HOLE	2



ENGINEERING, LLC

2008 Mustang Bullitt cont'd

Part No. 4FU218-050L/058L

PARTS LIST

IMPORTANT: Before beginning installation, verify that all parts are included in the kit. Report any shortages or damaged parts immediately.

PART NO.	DESCRIPTION	QTY.
7R007-001	NYLON RATCHET CLAMP 1-1/8"	16
7S175-400	SLEEVE, Ø1.75" X 4", BLUE	1
7S300-055	SLEEVE, 3.0 X 55 SILICONE	1
7S450-200	SLEEVE, 4 1/2 X 2, BLUE	1
7U030-046	5/32" VACUUM LINE	5
7U030-065	3/4"X90° RUBBER HOSE, SHORT	1
7U034-016	1" GS HEATER HOSE	3
7U038-000	3/4" HEATER HOSE	12
7U038-012	HOSE,3/4"DIA 90°,4X12 LEGS	2
7U038-150	HOSE, 3/4"X150° MOLDED HOSE	1
7U100-055	TIE WRAP, 7.5" NYLON	6
7U375-054	3/4" VINYL CAP	1
8D204-001	RACE BYPASS VALVE-BLUE/SATIN	1
8F001-403	PUMP, WATER, BOSCH	1
8N010-160	SURGE TANK BRKT, MUST GT	1
8N010-220	MTG BRKT, 05-07 MUST BOSCH PMP	1
8N055-050	PLASTIC CAP, SURGE TANK	1
8N056-061	SURGE TANK	1
8N106-135	WATER CLR ASY, 05 MUST GEN.II	1
8N006-020	WATER COOLR, FLDYN DUAL PASS	1
8N010-171	BRACKET, DRVR SIDE CLR MNT,PLT	1
8N010-173	BRACKET, PASS SIDE CLR MNT	1
2A017-036	SPACER,PLT.BRG.HSG.,0.186"	4
7C080-030	M8 X 1.25 X 30 HXHD CL10.9	6
7F008-020	NUT, M8 X 1.25	6
7J312-000	5/16 FLAT WASHER-SAE	12
7A250-051	1/4-20 X .50 HHCS ZINC PLTD	4
7J250-001	1/4 WASHER, SAE, PLTD	4
8N155-082	COOLANT RES RELOC, 07-08 MUST	1
4FU010-061	BRKT B, COOL RES RELOC MUST	1
4FU010-091	BRKT, COOL RES RELOC, 07 GT	1
7A250-051	1/4-20 X .50 HHCS ZINC PLTD	4
7A250-074	1/4-20 X .75 HHCS PLTD	3
7F250-021	1/4-20 NYLOCK NUT ZINC PLATED	3
7J006-093	6MM WASHER, PLATED	10
7P100-076	HOSE REDUCER, 1"->3/4" PLSTC	1
7P250-045	1/4 MALE NPT X 3/8 MALE BARB	1
7P375-050	3/8" HOSE UNION, BRASS	1
7R002-010	#10 SAE TYPE F SS HOSE CLAMP	2
7R004-002	STEPLESS CLAMP, 17.0-70	3
7U030-056	3/8 PCV/VAC RUBBER HOSE	2.5
7U038-000	3/4" HEATER HOSE	1.83
8N055-080	TANK, RAD OVERFLOW, MUST	1
8N201-200	CAC ASSY, LARGE, 05+ MUST GT P	1



ENGINEERING, LLC

2010 Mustang GT, Standard

Part No. 4FU218-080L/088L

PARTS LIST

IMPORTANT: Before beginning installation, verify that all parts are included in the kit. Report any shortages or damaged parts immediately.

PART NO.	DESCRIPTION	QTY.	PART NUMBER	DESCRIPTION	QTY.
008110	SMALL SILVER DIE CUT DECAL	2	7C060-015	M6 X 1.0 X 16MM SHCS CL10.9+ Z	2
008130	LICENSE PLATE FRAME	1	7C060-020	M6 X 1.0 X 20MM HX	2
008447	1 YR S/C WARRANTY PKG	1	7J006-094	6MM WASHER S.S.	2
009035	S/C LUBE, BOTTLED, 3-PACK	1	7R002-024	#24 HOSE CLAMP	3
2F329-010	V3 SUPERCHARGER ASY, STD	1	7U012-018	O-RING, 07 MUST GT THERM HSG	1
4FU020-010	INSTR MAN 05-10 MUST GT	1	4FU139-096	PCV MOD ASY	1
4FU110-101	P/S RELOCATE ASSY	1	7P375-106	PCV VALVE, FORD, 3/8" HOSE	1
4FU010-101	BRACKET P/S 2010 GT	1	7P625-377	5/8" -3/8" REDUCER BARB UNION	1
7A250-075	1/4-20 X .75 SHCS PLTD	1	7R004-002	STEPLESS CLAMP, 17.0-70	2
7F250-021	1/4-20 NYLOCK NUT ZINC PLATED	1	7R004-004	STEPLESS CLAMP, 1.0 OD HOSE	3
7J250-001	1/4 WASHER, SAE, PLTD	2	7R004-007	STEPLESS CLAMP, 28.6 X 7MM WID	1
7P375-050	3/8" HOSE UNION, BRASS	1	7U032-016	3/8" EFI FUEL HSE HI-PSR	0.25
7P375-075	3/4" HOSE BARB UNION, BRASS	2	7U033-020	HOSE, 5/8"ID CLASS 1 EMISSIONS	0.6667
7R004-002	STEPLESS CLAMP, 17.0-70	2	5A003-035	PREDATOR, 05-08 MUSTANG	1
7R004-007	STEPLESS CLAMP, 28.6 X 7MM WID	4	8F060-048	FUEL INJ, 39LB EV6, OEM 03 COB	8
7U032-016	3/8" EFI FUEL HSE HI-PSR	3FT	8F101-262	FUEL PMP ASY,05 MUST TWIN INTA	1
7U038-030	HOSE, P/S, 3/4 ID	4FT	7U032-018	3/8" SUBMERSIBLE EFI FUEL HOSE	2.75
4FU111-044	S/C MOUNTING BRKT ASY	1	7U100-055	TIE WRAP, 7.5" NYLON	4
4FU010-044	S/C MOUNT PLT, MUST GT	1	7R004-002	STEPLESS CLAMP, 17.0-70	2
4FU010-034	IDLER MOUNT PLATE, MUST	1	8F001-255	255 INTANK FUEL PUMP '86-'97	1
4FU017-011	SPACER, STUDDDED MUST GT	2	7R002-044	#44 HOSE CLAMP	1
2A017-750-05	SPACER, .750 OD X 2.691 LONG	2	7R004-006	STEPLESS CLAMP, 11.3 X 5MM WID	4
2A017-750-06	SPACER, .750 OD X 2.712 LONG	1	5W001-022	T-TAP CONN,14-16 AWG	2
2A017-879-08	SPACER, .875 OD X 1.776 LONG	1	5W001-009	16-14GA MALE SLIDE INSULATED	2
2A017-750-07	SPACER, .750 OD X .097 LONG	1	5W001-080	FUSE, 20 AMP. MINI BLADE	1
4FU017-021	SPACER, IDLER, MUST GT	1	7P375-099	Y-UNION, 3/8" BARBED TEFLON	1
4PCS016-160	PULLEY, IDLER	1	7U032-025	HOSE, 5/16" ID,3/8"OD, 1/32" W	0.125
2A046-120	BELT, GATES K061203	1	7U032-030	HOSE, SPIRAL 3/8" CUFF ID, 1' L	2
7A375-375	3/8-16 X 3-3/4 HX HD	1	4FU101-001	MAF EXT MOD 05+ MUSTANG	1
7C080-150	M8 X 1.25 X 150MM HXHD CL10.9	1	5W018-030	18GA STRD WIRE GREY	1
7C080-140	M8 X 1.25 X 140 HXHD CL8.8	2	5W018-010	18GA STRD WIRE RED	1
7A375-100	3/8-16 X 1 G5 HHCS, PLT	7	5W018-020	18GA STRD WIRE BLK, UL1015	1
7K312-030	5/16 AN WASHER, S.S.	2	5W018-080	18GA STRD WIRE BLUE BULK	1
7K375-040	3/8 AN960 FLAT WASHR PLATED	10	5W018-090	18GA STRD WIRE BROWN BULK	1
4FU112-010	AIR INTAKE ASY	1	5W018-100	18GA STRD WIRE PURPLE	1
4FU012-010	INLET DUCT,"A"	1	5W001-007	3/16" HEAT-SHRINK TUBING	1.5
4FU012-015	INLET DUCT,"B"	1	5W001-005	3/8" PLASTIC WIRE LOOM	1.5
7R002-056	#56 HOSE CLAMP	1	5W001-012	18-22 GA BUTT CONN RED INSUL	12
7S400-200	SLEEVE, 4 X 2, BLUE	2			
7S400-351	REDUCER SLV 4.00 X 3.5 X 2.35L	1			
7R002-064	#64 HOSE CLAMP	5			
8H040-235	AIR FILTER, 4.0FLG X 7.0L	1			
8A003-071	MAF, 3.8 I.D. MUSTANG GT	1			
7P750-102	3/4NPT X 1" X 90° HSE FIT	1			
7P250-047	1/4NPT TO 3/8" BARB 90°	1			
4FU010-071	BRKT, INTAKE SUPPORT	1			
7U032-016	3/8" EFI FUEL HSE HI-PSR	4			
4FU013-010	COVER, AIR FILTER, MUST GT	1			
7C040-008	M4-.7X8MM SCHD SS	2			
4FU112-020	DISCHARGE ASY	1			
4FU012-020	DUCT, DISCH, MUST GT STD	1			
7S450-200	SLEEVE, 4 1/2 X 2, BLUE	1			
7S300-276	REDUCER, 3.0 X 2.75 X 2.5L	1			
7R002-044	#44 HOSE CLAMP	1			
7R002-048	#48 HOSE CLAMP	1			
7R002-072	#72 HOSE CLAMP	2			
7R002-016	#16 HOSE CLAMP	4			
7U030-046	5/32" VACUUM LINE	5			
8D001-001	STD COMPRESS BYPASS VALVE	1			
7U034-016	1" GS HEATER HOSE	1.25			
7U034-016	1" GS HEATER HOSE	0.583			
7P218-156	VAC TEE, 7/32,7/32,5/32	1			
4FU114-030	WATER PIPE ASSY, 07-08 MUST GT	1			
4FU014-051	HOUSING, THRST RELC 07 MUST G	1			
4FU014-060	WATER PIPE, Ø1.5 X 90°,07 MUST	1			
5W001-085	SLEEVE, FLEX BRD Ø1.5" NOM.	0.83			



ENGINEERING, LLC

2010 Mustang GT, H.O.

Part No. 4FU218-100L/108L

PARTS LIST

IMPORTANT: Before beginning installation, verify that all parts are included in the kit. Report any shortages or damaged parts immediately.

PART NO.	DESCRIPTION	QTY.	PART NUMBER	DESCRIPTION	QTY.
008110	SMALL SILVER DIE CUT DECAL	2	4FU139-096	PCV MOD ASY	1
008130	LICENSE PLATE FRAME, VORTECH	1	7P375-106	PCV VALVE, FORD, 3/8" HOSE	1
008341	VORTECH CHARGE COOLER DECAL	1	7P625-377	5/8" -3/8" REDUCER BARB UNION	1
008447	1 YR S/C WARRANTY PKG	1	7R004-002	STEPLESS CLAMP, 17.0-70	2
009035	S/C LUBE, BOTTLED, VORT 3-PACK	1	7R004-004	STEPLESS CLAMP, 1.0 OD HOSE	3
2F329-020	V3 SUPERCHARGER ASY, H.O.	1	7R004-007	STEPLESS CLAMP, 28.6 X 7MM WID	1
4FU020-010	INSTR MAN 05-10 MUST GT	1	7U032-016	3/8" EFI FUEL HSE HI-PSR	0.25
4FU110-101	P/S RELOCATE ASSY	1	7U033-020	HOSE, 5/8"ID CLASS 1 EMISSIONS	0.6667
4FU010-101	BRACKET P/S 2010 GT	1	5A001-025	DIABLO MAFIA	1
7A250-075	1/4-20 X .75 SHCS PLTD	1	5A003-035	PREDATOR, 05-08 MUSTANG	1
7F250-021	1/4-20 NYLOCK NUT ZINC PLATED	1	8F060-048	FUEL INJ, 39LB EV6, OEM 03 COB	8
7J250-001	1/4 WASHER, SAE, PLTD	2	8F101-262	FUEL PMP ASY,05 MUST TWIN INTA	1
7P375-050	3/8" HOSE UNION, BRASS	1	7U032-018	3/8" SUBMERSIBLE EFI FUEL HOSE	2.75
7P375-075	3/4" HOSE BARB UNION, BRASS	2	7U100-055	TIE WRAP, 7.5" NYLON	4
7R004-002	STEPLESS CLAMP, 17.0-70	2	7R004-002	STEPLESS CLAMP, 17.0-70	2
7R004-007	STEPLESS CLAMP, 28.6 X 7MM WID	4	8F001-255	255 INTANK FUEL PUMP '86-'97	1
7U032-016	3/8" EFI FUEL HSE HI-PSR	3FT	7R002-044	#44 HOSE CLAMP	1
7U038-030	HOSE, P/S, 3/4 ID	4FT	7R004-006	STEPLESS CLAMP, 11.3 X 5MM WID	4
4FU111-044	S/C MOUNTING BRKT ASY	1	5W001-022	T-TAP CONN,14-16 AWG	2
4FU010-044	S/C MOUNT PLT, MUST GT	1	5W001-009	16-14GA MALE SLIDE INSULATED	2
4FU010-034	IDLER MOUNT PLATE, MUST	1	5W001-080	FUSE, 20 AMP, MINI BLADE	1
4FU017-011	SPACER, STUDDER MUST GT	2	7P375-099	Y-UNION, 3/8" BARBED TEFLON	1
2A017-750-05	SPACER, .750 OD X 2.691 LONG	2	7U032-025	HOSE, 5/16" ID,3/8"OD, 1/32" W	0.125
2A017-750-06	SPACER, .750 OD X 2.712 LONG	1	7U032-030	HOSE, SPIRAL 3/8" CUFF ID, 1' L	2
2A017-879-08	SPACER, .875 OD X 1.776 LONG	1	8N101-290	WELDED CORE ASY	1
2A017-750-07	SPACER, .750 OD X .097 LONG	1	8N104-125	SUPRT PCS, 05-08 MUST GT CLR G	1
4FU017-021	SPACER, IDLER, MUST GT	1	4FE014-010	RADIATOR PIPE-STAINLESS	1
4PCS016-160	PULLEY, IDLER	1	5W001-009	16-14GA MALE SLIDE INSULATED	1
2A046-120	BELT, GATES K061203	1	5W001-011	16-14 GA RING TERM .26" HOLE	1
7A375-375	3/8-16 X 3-3/4 HX HD	1	5W001-015	FUSE, BLADE TYPE 20 AMP	1
7C080-150	M8 X 1.25 X 150MM HXHD CL10.9	1	5W001-022	T-TAP CONN,14-16 AWG	1
7C080-140	M8 X 1.25 X 140 HXHD CL8.8	2	5W001-032	1/4" PLASTIC WIRE LOOM	60
7A375-100	3/8-16 X 1 G5 HHCS, PLT	7	5W001-050	HARNESS, FUEL INJ PLUG W/WIRES	1
7K312-030	5/16 AN WASHER, S.S.	2	5W001-071	FUSE HOLDER,16GA WIRE	1
7K375-040	3/8 AN960 FLAT WASHR PLATED	10	5W018-010	18GA STRD WIRE RED	5
4FU112-010	AIR INTAKE ASY	1	7A250-050	1/4-20 X .50 SHCS ZINC PLTD	3
4FU012-010	INLET DUCT,"A"	1	7A250-051	1/4-20 X .50 HHCS ZINC PLTD	2
4FU012-015	INLET DUCT,"B"	1	7A250-074	1/4-20 X .75 HHCS PLTD	2
7R002-056	#56 HOSE CLAMP	1	7F250-020	1/4-20 HEX NUT	2
7S400-200	SLEEVE, 4 X 2, BLUE	2	7J006-093	6MM WASHER, PLATED	5
7S400-351	REDUCER SLV 4.00 X 3.5 X 2.35L	1	7J250-001	1/4 WASHER, SAE, PLTD	4
7R002-064	#64 HOSE CLAMP	5	7P156-082	5/32 TEE	1
8H040-235	AIR FILTER, 4.0FLG X 7.0L	1	7P218-156	VAC TEE, 7/32,7/32,5/32	1
8A003-071	MAF, 3.8 I.D. MUSTANG GT	1	7P375-075	3/4" HOSE BARB UNION, BRASS	4
7P750-102	3/4NPT X 1" X 90° HSE FIT	1	7P500-026	1/2NPT X 3/4 BARB 90° BRASS	2
7P250-047	1/4NPT TO 3/8"BARB 90°	1	7P500-078	1/2NPT X 3/4 HOSE FIT STRT	2
4FU010-071	BRKT, INTAKE SUPPORT	1	7R002-016	#16 HOSE CLAMP	4
7U032-016	3/8" EFI FUEL HSE HI-PSR	4	7R002-024	#24 HOSE CLAMP	2
4FU013-010	COVER, AIR FILTER, MUST GT	1	7R002-044	#44 HOSE CLAMP	2
7C040-008	M4-.7X8MM SCHD SS	2	7R002-072	#72 HOSE CLAMP	2
4FU114-030	WATER PIPE ASSY, 07-08 MUST GT	1	7R003-016	ADEL CLAMP, 1.0"	1
4FU014-051	HOUSING, THRMST RELC 07 MUST G	1	7R003-028	ADEL CLAMP, 2-3/8", .26 HOLE	2
4FU014-060	WATER PIPE, Ø1.5 X 90°,07 MUST	1	7R007-001	NYLON RATCHET CLAMP 1-1/8"	16
5W001-085	SLEEVE, FLEX BRD Ø1.5" NOM.	0.83	7S275-055	ELBOW, Ø2.75 X 55° SILICONE	1
7C060-015	M6 X 1.0 X 16MM SHCS CL10.9+ Z	2	7S450-200	SLEEVE, 4 1/2 X 2, BLUE	1
7C060-020	M6 X 1.0 X 20MM HX	2	7U030-046	5/32" VACUUM LINE	5
7J006-094	6MM WASHER S.S.	2	7U030-065	3/4"X90° RUBBER HOSE, SHORT	1
7R002-024	#24 HOSE CLAMP	3	7U034-016	1" GS HEATER HOSE	1
7U012-018	O-RING, 07 MUST GT THERM HSG	1	7U034-016	1" GS HEATER HOSE	1.25
			7U038-000	3/4" HEATER HOSE	12
			7U038-012	HOSE,3/4"DIA 90°,4X12 LEGS	1
			7U038-020	HOSE, Ø3/4 'S' MOLDED RUBBER	1



ENGINEERING, LLC

2010 Mustang GT, H.O. cont'd

Part No. 4FU218-108L/108L

PARTS LIST

IMPORTANT: Before beginning installation, verify that all parts are included in the kit. Report any shortages or damaged parts immediately.

PART NO.	DESCRIPTION	QTY.	PART NUMBER	DESCRIPTION	QTY.
7U038-150	HOSE, 3/4"X150° MOLDED HOSE	1	7S450-200	SLEEVE, 4 1/2 X 2, BLUE	1
7U100-055	TIE WRAP, 7.5" NYLON	6	7U030-046	5/32" VACUUM LINE	5FT
7U375-054	3/4" VINYL CAP	1	7U030-065	HOSE, 3/4 X 90° RUBBER, SHORT	1
8D001-001	STD COMPRESS BYPASS VALVE	1	7U034-016	1" GS HEATER HOSE	1FT
8F001-403	PUMP, WATER, BOSCH	1	7U034-016	1" GS HEATER HOSE	1.25FT
8N010-160	SURGE TANK BRKT, MUST GT	1	7U038-000	3/4" HEATER HOSE	12FT
8N010-220	MTG BRKT, 05-07 MUST BOSCH PMP	1	7U038-012	HOSE, 3/4 DIA 90°, 4 X 12 LEGS	1
8N055-050	PLASTIC CAP, SURGE TANK	1	7U038-020	HOSE, 3/4 DIA 'S' MOLDED RUBBE	1
8N056-061	SURGE TANK INTEGRA GSR MODIFIE	1	7U038-150	HOSE, 3/4 D X 150° MOLDED HOSE	1
8N106-135	WATER CLR ASY, MUST GEN.II	1	7U100-055	TIE WRAP, 7.5" NYLON	6
8N006-020	WATER COOLR, FLDYN DUAL PASS	1	7U375-054	3/4" VINYL CAP	1
8N010-171	BRACKET, DRVR SIDE CLR MNT,PLT	1	8D001-001	STD COMPRESS BYPASS VALVE	1
8N010-173	BRACKET, PASS SIDE CLR MNT	1	8F001-403	PUMP, WATER, BOSCH	1
2A017-036	SPACER,PLT.BRG.HSG.,0.186"	4	8N010-160	SURGE TANK BRKT, 05 MUST GT	1
7C080-030	M8 X 1.25 X 30 HHXD CL10.9	6	8N055-050	PLASTIC CAP, SURGE TANK	1
7F008-020	NUT, M8 X 1.25	6	8N056-061	SURGE TANK INTEGRA GSR MODIFIE	1
7J312-000	5/16 FLAT WASHER-SAE	12	8N010-340	MTG BRKT 2010 MUST GT BOSCH PM	1
7A250-051	1/4-20 X .50 HHCS ZINC PLTD	4	7U133-060	3/4" X 90° HOSE 5"X3.5" LEGS	1
7J250-001	1/4 WASHER, SAE, PLTD	4	7A250-376	1/4-20 X 3/4 SHOULDER SHCS NYL	2
8N155-082	COOLANT RES RELOC, 07-08 MUST	1	7F250-021	1/4-20 NYLOCK NUT ZINC PLATED	2
4FU010-061	BRKT B, COOL RES RELOC MUST	1	7C010-075	M8 X 1.25 X75 STUD	4
4FU010-091	BRKT, COOL RES RELOC, 07 GT	1	2A017-753-02	SPACER, 750 OD X .880 LONG	4
7A250-051	1/4-20 X .50 HHCS ZINC PLTD	4	7J008-001	5/16" FENDER WASHERS	4
7A250-074	1/4-20 X .75 HHCS PLTD	3	7F008-023	NUT, M8 X 1.25 NYLOCK NUT	8
7F250-021	1/4-20 NYLOCK NUT ZINC PLATED	3	7A250-376	1/4-20 X 3/4 SHOULDER SHCS NYL	2
7J006-093	6MM WASHER, PLATED	10	7F250-021	1/4-20 NYLOCK NUT ZINC PLATED	2
7P100-076	HOSE REDUCER, 1"->3/4" PLSTC	1			
7P250-045	1/4 MALE NPT X 3/8 MALE BARB	1			
7P375-050	3/8" HOSE UNION, BRASS	1			
7R002-010	#10 HOSE CLAMP	2			
7R004-002	STEPLESS CLAMP, 17.0-70	3			
7U030-056	3/8 PCV/VAC RUBBER HOSE	2.5			
7U038-000	3/4" HEATER HOSE	1.83			
8N055-080	TANK, RAD OVERFLOW, MUST	1			
8N104-127	SUPRT PCS, 2010 MUST GT CLR	1			
4FE014-010	RADIATOR PIPE-STAINLESS	1			
5W001-009	16-14GA MALE SLIDE INSULATED	1			
5W001-011	16-14 GA RING TERM .26" HOLE	1			
5W001-015	FUSE, BLADE TYPE 20 AMP	1			
5W001-022	T-TAP CONN,14-16 AWG	1			
5W001-032	1/4" PLASTIC WIRE LOOM	60IN			
5W001-050	HARNES, FUEL INJ PLUG W/WIRES	1			
5W001-071	FUSE HOLDER,16GA WIRE	1			
5W018-010	18GA STRD WIRE RED	5FT			
7A250-050	1/4-20 X .50 SHCS GR8 ZINC PLT	3			
7A250-051	1/4-20 X .50 HHCS GR5 ZINC PLT	2			
7A250-074	1/4-20 X .75 HHCS PLTD	2			
7F250-020	1/4-20 HEX NUT	2			
7J006-093	6MM WASHER, PLATED	5			
7J250-001	1/4 WASHER, SAE, PLTD	4			
7P156-082	5/32 TEE	1			
7P218-156	VAC TEE, 7/32,7/32,5/32	1			
7P375-075	3/4" HOSE BARB UNION, BRASS	5			
7P500-026	1/2NPT X 3/4 BARB 90° BRASS	2			
7P500-078	1/2NPT X 3/4 HOSE FIT STRT	2			
7R002-016	#16 SAE TYPE F SS HOSE CLAMP	4			
7R002-024	#24 SAE TYPE F SS HOSE CLAMP	2			
7R002-044	#44 SAE TYPE F SS HOSE CLAMP	2			
7R002-072	#72 SAE TYPE F SS HOSE CLAMP	2			
7R003-016	ADEL CLAMP, 1.0"	1			
7R003-028	ADEL CLAMP, 2-3/8" .26 HOLE	2			
7R007-001	NYLON RATCHET CLAMP 1-1/8"	18			
7S275-055	ELBOW, °2.75 X 55° SILICONE	1			

1. PREPARATION/REMOVAL

- A. Disconnect the battery before proceeding.
- B. Loosen the hose clamp at the throttle body. Disconnect the plastic 3/8" tube assembly attached to the passenger's side valve cover. Remove the plastic 3/8" x 90° connector from the plastic tube that was connected at the passenger's side valve cover. Set this connector aside to be re-used in a later step. Discard the remainder of the hose assembly, as it will not be re-used. (See Fig. 1-c.)

NOTE: The preferred method of removing the 90° connector from its original plastic tube is to apply a small amount of heat to the tube and slide the connector free.

- C. Disconnect the mass air flow (MAF) sensor plug and remove the inlet duct and upper air filter cover from the car if applicable. (See Figs. 1-a, 1-b, 1-c.)
- D1. Remove the 10mm headed bolt (located next to the inner fender) which secures the lower portion of the air filter enclosure. Remove the lower portion from the car - it will not be reused. (See Fig. 1-d.)
- D2. (Bullitt Only) Remove silver nut washer securing the front of the intake shroud. (see Fig 1-d1.)
- E. Remove the six plastic push pins securing the radiator cover. Remove the cover and set aside to be reinstalled later. (See Fig. 1-e.)

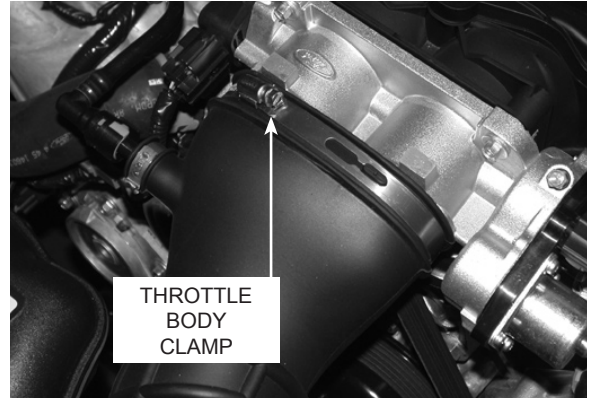

Fig. 1-a



Fig. 1-b

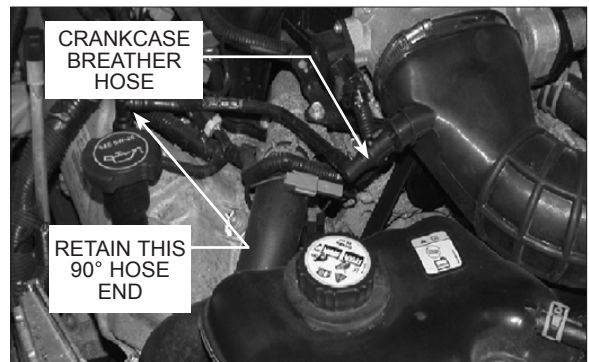

Fig. 1-c



Fig. 1-d1 (Bullitt Only)

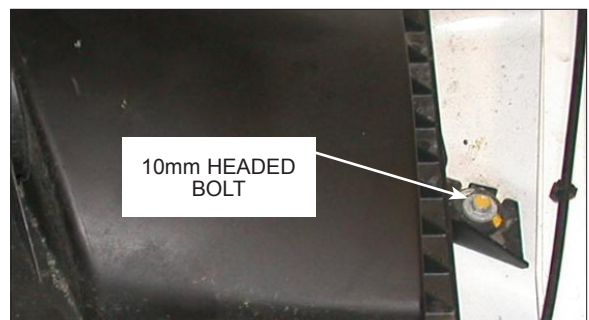

Fig. 1-d

1. PREPARATION/REMOVAL, cont'd

- F. Locate the coolant drain plug on the passenger's side of the radiator. Next drain the coolant into a clean container. This coolant will be reused in a later step.

NOTE: Loosening the coolant reservoir cap will allow for coolant to drain more freely.

- G. Remove the two 8mm headed bolts securing the coolant overflow reservoir to the plastic fan shroud. (See Fig. 1-f.)
- H. Disconnect the small overflow hose (running across the top of the radiator) from the overflow reservoir. (See Fig. 1-f.)
- I.1 (2007-2010 Models and Bullitt Only) Remove the large hose connected to the bottom of the coolant overflow reservoir. (See Fig. 1-g.)
- I.2 (2005-2006 Only) Remove the large hose connecting the thermostat housing to the bottom of the overflow reservoir. Set the hose and reservoir aside to be reinstalled in a later step. (See Fig. 1-g.)

NOTE: If you are installing H.O. (charge cooled) kit, the coolant reservoir will not be reused. Retain only the fill cap for reuse.

- J.1. (2005-2006 Only) Remove the two upper radiator hoses from the engine coolant crossover tube and set aside. The radiator hose located on the driver's side will not be reused. (See Fig. 1-g.)
- J.2. (2007-2010 Only) Remove single upper radiator hose. This hose will be reused in a later step.
- K. (2005-2006 Only) Remove the thermostat housing from the large formed hose leading to the engine block and the lower outlet of the radiator. (See Fig. 1-h.) Set the thermostat housing aside to be reinstalled in a later step.
- L. (2005-2006 Only) Remove the lower hose on the radiator and set the hose aside, as it will not be reused.
- M. Drain and remove the power steering reservoir. This reservoir will be relocated in a later step.
- N.1 Disconnect and remove the factory 5/8" plastic breather hose assembly attached to the driver's side valve cover and intake manifold. Remove the two fittings from the ends of the plastic tube for reuse. Discard the striped plastic tube. (See Fig. 1-i.)
- N.2 (Bullitt Only) Remove strut tower brace two nuts each side with a 13mm socket.

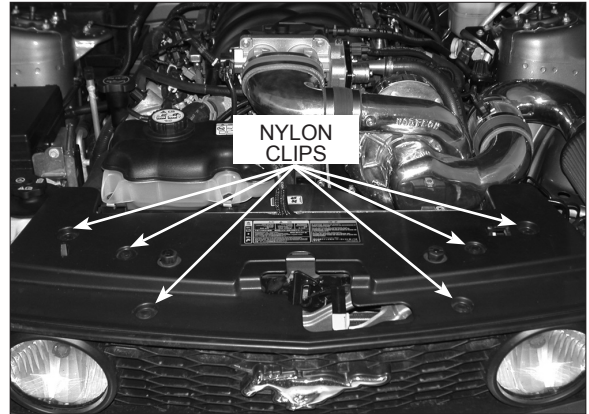

Fig. 1-e

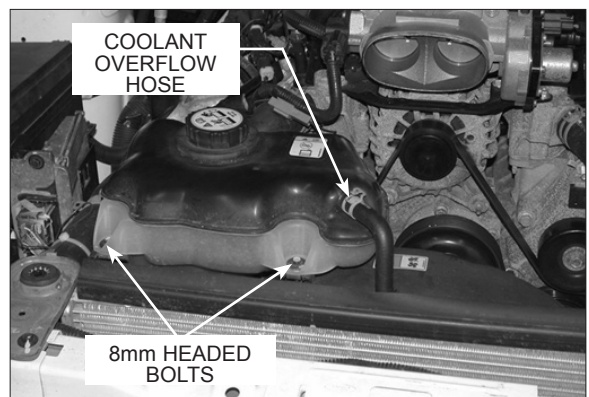

Fig. 1-f

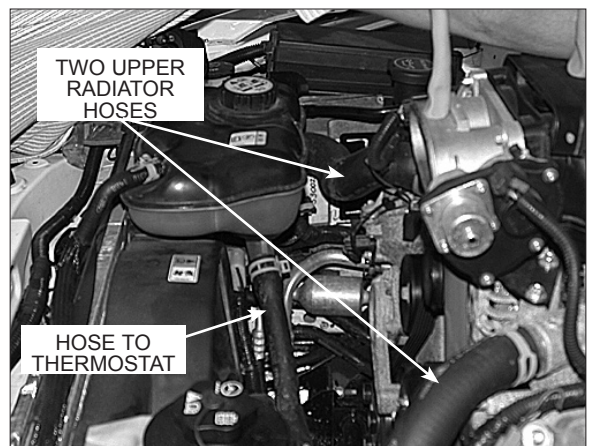

Fig. 1-g

1. PREPARATION/REMOVAL, cont'd

O. The installation of this supercharger system requires the removal, in part or whole, of the intake manifold so that modifications can be made to the coolant crossover tube or thermostat housing depending on year of application:

1. **(2005-2006 Only)** Unplug the wire connectors from each of the eight injectors. Remove all of the vacuum hoses and connectors located at the front and rear of the intake manifold. Remove the connector attached to the intake manifold runner control (IMRC) unit located at the rear of the manifold on the passenger's side.
2. **(2007-2010 Only):** Unplug the wire connectors from each of the eight injectors.
3. Remove the four 8mm headed bolts securing the injector rails to the intake manifold. Do not remove the small clips that retain the injectors to the fuel rails. Using a 5/8" spring lock tool, disconnect the fuel feed line from the fuel rail. Remove the vacuum line from the fuel regulator. Remove the rails and injectors as a complete unit and set aside. New injectors will be installed in a later step. (See Figs. 1-i, 1-j.)
4. Locate and remove the remaining 10mm headed bolts retaining the intake manifold to the cylinder heads. There are **five** on each side.
5. **(2005-2006 Only):** Remove the intake manifold and set aside so it can be reinstalled after modifications to the coolant crossover tube are made.

NOTE: Modification to the crossover tube will be completed in a later step

6. **(2007-2010 Only):** It is not necessary to remove the intake manifold from the vehicle completely. Raise the front of the manifold 3-4" and support between the throttle-body and alternator.

NOTE: Modification to the thermostat will be completed in a later step.

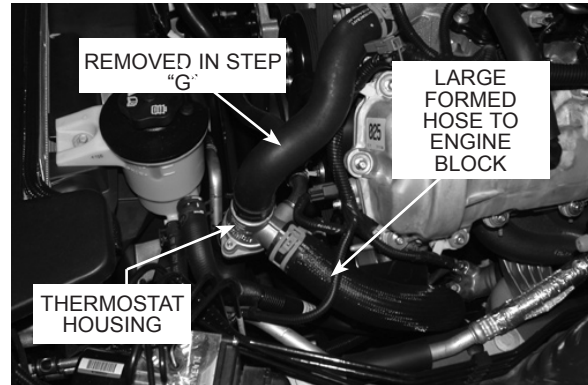

Fig. 1-h

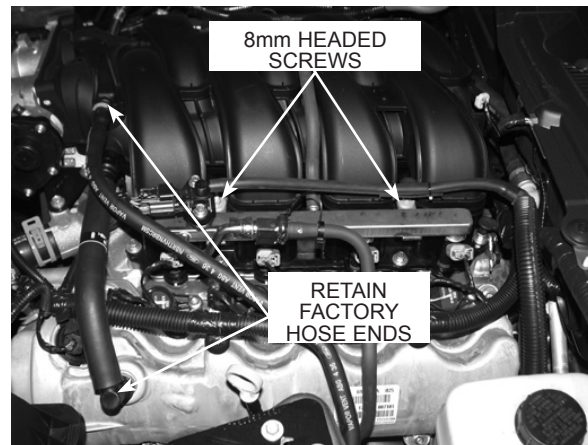

Fig. 1-i

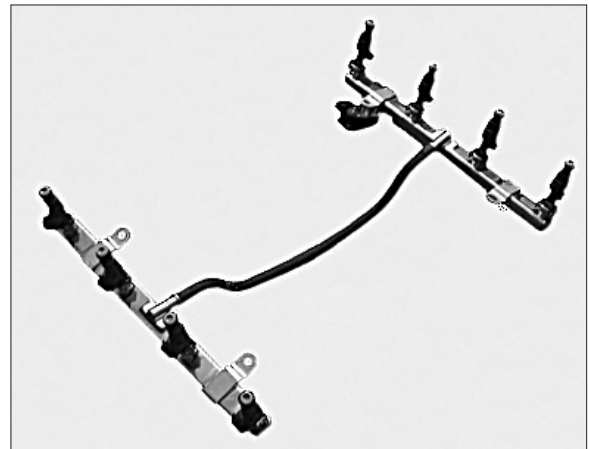

Fig. 1-j

1. PREPARATION/REMOVAL, cont'd

- P. Using a 1/2" ratchet, release the tension from the accessory drive belt and remove it from the car. This drive belt will be replaced with a longer one later in the installation.
- Q. Locate and remove the stud bolt that secures the alternator in place as well as the bolt located to the right of the alternator. (See Fig. 1-o.) Using a 15mm socket or wrench, remove the nut that secures the capacitor, resistor and coolant hose support bracket to the stud bolt. Using an 18mm socket or wrench, remove the stud bolt, it will be modified and replaced in a later step.

On **2010 Models**, no coolant hose support bracket is used.

- R. There is a small tab that secures the wiring harness in place on the valve cover that will need to be removed to gain clearance for the supercharger belt. This tab is best removed with a small air saw but a grinder will work. After removal, smooth the area to prevent damage to the belt. (See Figs. 1-r, 1-r1.)
- S. As seen in Fig. 1-o, the upper bolt is removed from the timing chain cover. This bolt will have to be modified by cutting off the threaded end where the resistor attaches. Modify and reinstall the bolt. (See Fig. 1-s.)
- T. Disconnect the plug to the cam position sensor. Remove the wiring harness from the retaining clips that hold it to the valve cover. Move the harness out of the way. This harness will have to be relocated to gain clearance for the supercharger.

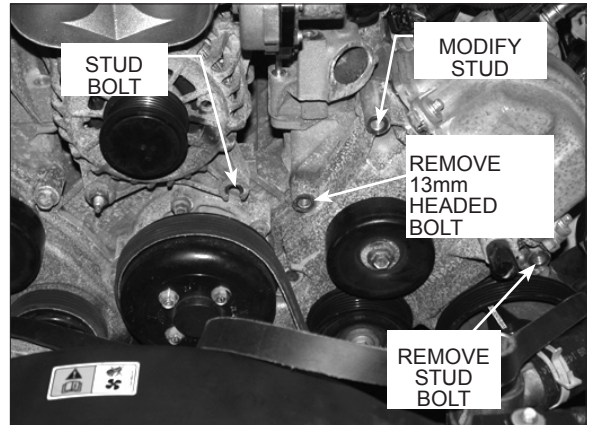

Fig. 1-o



Fig. 1-r

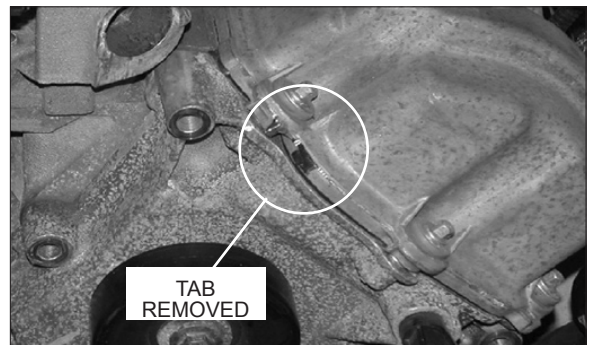

Fig. 1-r1

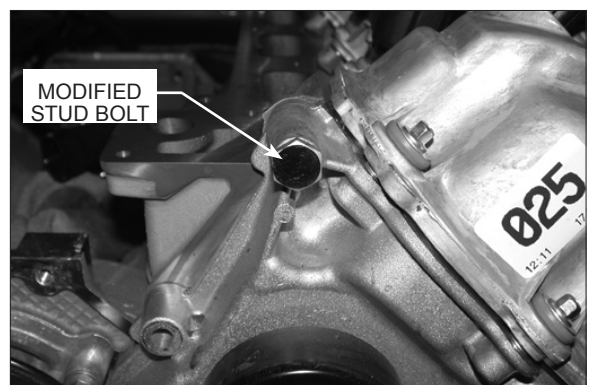

Fig. 1-s

2. OIL FEED INSTALLATION (Engine oil-fed kits only. Applications with V-3 superchargers skip ahead to step 4.)

- A. Locate the factory oil sensor on the driver's side of the vehicle near the oil filter.
- B. Remove the sending unit and set aside.
- C. Locate the supplied 1/4"NPT street TEE fitting. Install the TEE in the same location as the factory sending unit with the 1/4" x -4 x 90° installed on the TEE at the location noted. (See Fig. 2-a.)
- D. Attach the stainless steel -4 hose to the -4 fitting installed in the street TEE. (See Fig. 2-a.)
- E. Route the hose away from hot, sharp or moving parts and move to the top of the engine where it will be attached to the supercharger oil feed.
- F. Reinstall the factory sensor in the branch of the TEE as shown. (See Fig. 2-a.)

NOTE: The oil feed hose to the S/C will be installed in a later step of the installation. Temporarily cap the open end of the hose to prevent contamination to the inside of the hose.



Fig. 2-a

3. OIL DRAIN ASSEMBLY INSTALLATION (Engine oil-fed kits only. Applications with V-3 superchargers skip ahead to step 4.)

- A. To provide an oil drain for the supercharger, it is necessary to make a hole in the oil pan. It is best to *punch* the hole rather than to drill it.
- B. Remove paint from the area around the hole.
- C. Mark the oil pan 5/8" down from the oil pan mounting rail on the driver's side of the engine. Measure forward 3/4" from the first bolt on the side of the oil pan. (See Fig. 3-a.)
- D. Use a small center punch to perforate the pan and expand the hole. Switch to a larger diameter punch and expand the hole further to approximately $\text{Ø}9/16"$. Most punches are made from hexagon material and may be placed in a socket with an extension to make this procedure easier.
- E. Tap the hole with a 3/8"NPT tap approximately 1/4" deep. Pack the flutes of the tap with heavy grease to hold chips. Use a small magnet to check for any stray chips.

NOTE: This method of rolling over the lip of the hole and tapping it works very well if carefully done and should cause no problems.

- F. Thoroughly clean the threaded area. Apply a small amount of silicone sealer or teflon paste to the new threads. Apply more sealer to the 3/8"NPT hose fitting and secure in the hole. Make sure a seal is formed all around the fitting. (See Fig. 3-b.)
- G. Drain the engine oil and change the filter.

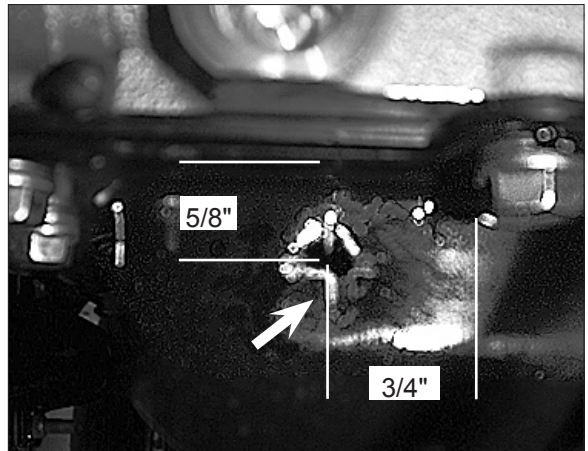

Fig. 3-a

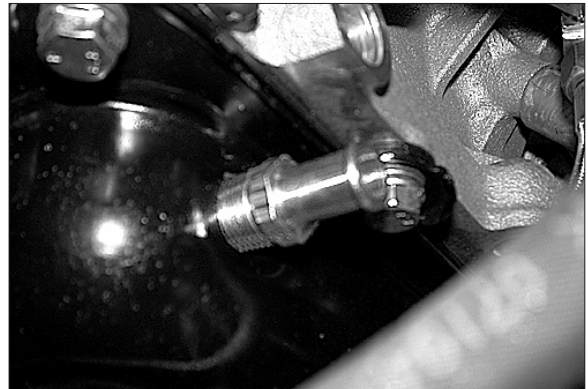

Fig. 3-b

4. POWER STEERING RELOCATION (2010 Models Skip to Step 4.1)

- A. Locate the power steering assembly 4FU110-010.
- B. Attach the power steering (P/S) relocation bracket 4FU010-010 with the hardware provided to the P/S reservoir removed in an earlier section. (See Fig. 4-a.)
- C. Attach the 3/4" P/S hose along with the 3/8" P/S hose to the outlets of the reservoir with the clamps provided. (See Fig. 4-b.)
- D. Attach the 3/4" and the 3/8" hose barb unions to the factory hoses using the factory clamps.
- E. Attach the reservoir to the passenger's side radiator core support using one of the factory ground strap retaining bolts. (See Fig. 4-c.)
- F. Attach the hoses from the reservoir to the factory P/S hoses and secure with the supplied clamps. Trim for best fit. Secure the hose to the fan shroud away from heat and moving objects.
- G. It will be necessary to trim the corner of the radiator core support cover to clear the relocated P/S reservoir. (See Fig. 4-d)



Fig. 4-b

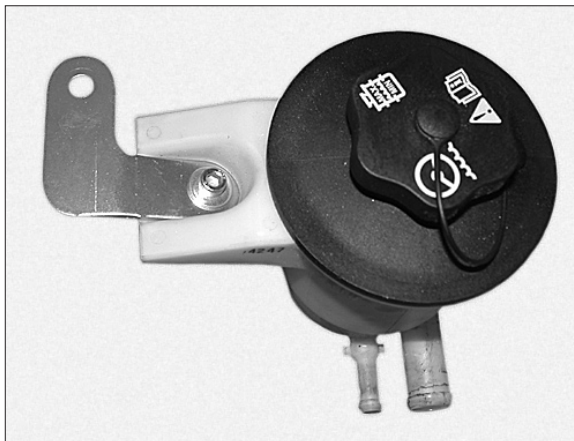

Fig. 4-a



Fig. 4-c



Fig. 4-d

4.1 POWER STEERING RELOCATION (2010 Models Only)

- A. Locate the power steering assembly 4FU110-010.
- B. Attach the power steering (P/S) relocation bracket P/N 4FU010-101 (R) with the hardware provided to the P/S reservoir removed in an earlier section.
- C. Locate the factory 3/4" PS hose and cut off the 90° bend as shown. See fig 4.1a.
- D. Using a 3/4" brass union and two stepless clamps, attach the 90° bend to a length of supplied 3/4" hose as shown. See fig 4.1b.
- E. Attach 90° 3/4" and a length of supplied 3/8" hose to reservoir using the factory clamps. Remove the inboard 13mm headed strut mount nuts and install PS reservoir assembly in location shown. See fig 4.1c.
- F. Route hoses towards front of vehicle away from exhaust and moving objects.
- G. Connect previously installed PS hoses from reservoir to the factory PS hoses using the appropriate brass unions and hose clamps. See fig 4.1d.



Fig. 4.1a



Fig. 4.1b



Fig. 4.1d



Fig. 4.1c

5.1 COOLANT TUBE RELOCATION (2005-2006 Models Years Only)

NOTE: For 2007-2010 Models skip to Section 5.2.

- A. Locate assembly 4FU214-021.
- B. Remove the hose connected to the back, lower portion of the engine coolant crossover tube. (See Fig. 5.1-a.)
- C. Remove the nylon clip retaining the wire harness to the alternator brace and the four 10mm headed bolts securing the alternator brace. Set the brace aside to be reinstalled. (See Fig. 5.1-b.)
- D. Remove the factory coolant bleed plug and set the plug aside. It will not be reused. (See Fig. 5.1-c.)
- E. Remove the remaining two 10mm head bolts securing the crossover tube to the cylinder heads.

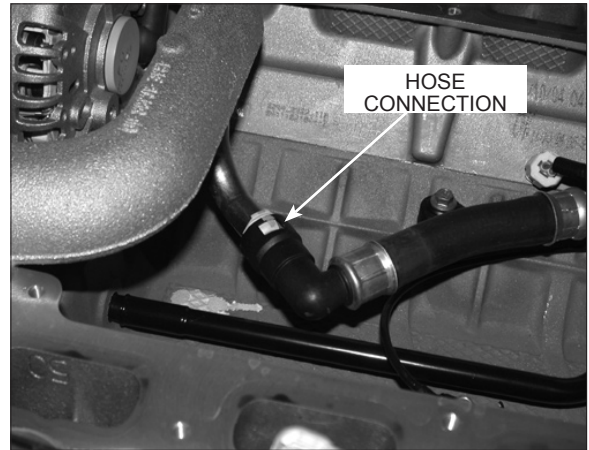

Fig. 5.1-a

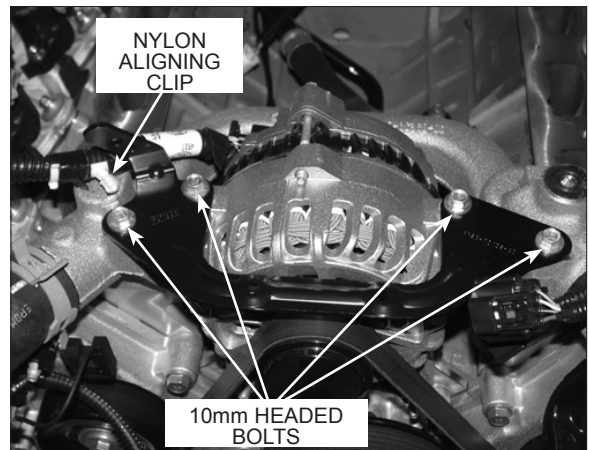

Fig. 5.1-b

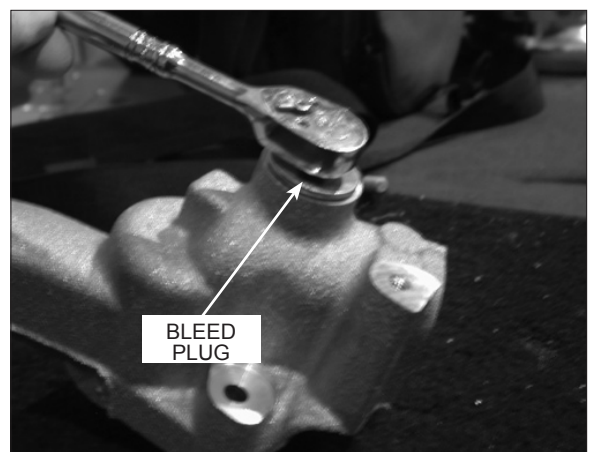

Fig. 5.1-c

5.1 COOLANT TUBE RELOCATION (2005-2006 Models Years Only), cont'd

- F. Remove the factory O-ring type gaskets to prevent damage from heat. Clamp the steel hose barb end of the coolant crossover tube in a vise as shown. Using a small amount of heat, heat the aluminum crossover tube. Using a twisting motion, remove the steel insert. (See Fig. 5.1-d.) Penetrating oil will also aid in this step.
- G. Locate the supplied 1-1/4" expansion plug (7P125-002).
- H. Coat the expansion plug with sealant. Using a tube or socket that matches the recessed diameter of the plug, install the plug flush with the machined surface sealing the outlet of the crossover tube. (See Figs. 5.1-e, 5.1-f.)
- I. Locate the supplied coolant relocation fitting, sealing nut and O-ring washer. (See Fig. 5.1-g.)
- J. Install the fitting in the location of the factory coolant bleed plug. (See Fig. 5.1-h.) Screw the jam nut all the way onto the fitting. Tighten the fitting in the position shown. (See Fig. 5.1-h.) Secure with the jam nut.

NOTE: It is recommended that sealant be used to seal the thread of the fitting.

- K. Reinstall the factory O-ring gaskets to the crossover tube.
- L. Set the coolant crossover tube back in its original location.
- M. Reinstall the two 10mm headed bolts through the crossover tube into the cylinder heads. Temporarily install two intake manifold retaining bolts through the crossover tube into the cylinder heads, where the manifold will be secured. Leave these loose as they are there only as a pilot for the crossover tube.
- N. Tighten the crossover tube retaining bolts, and remove the two manifold retaining bolts.



Fig. 5.1-d

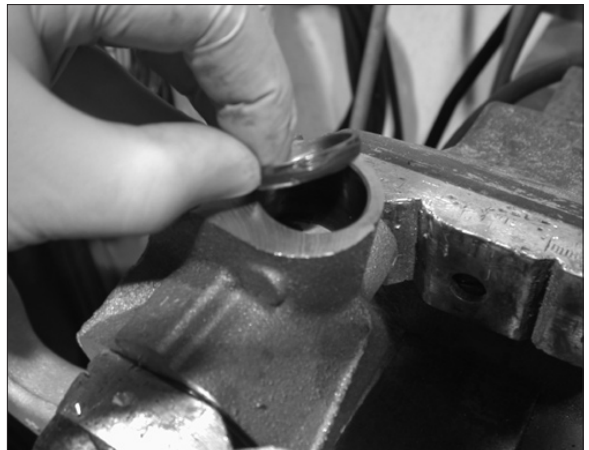

Fig. 5.1-e



Fig. 5.1-f

5.1 COOLANT TUBE RELOCATION (2005-2006 Models Years Only), cont'd

- O. Reconnect the coolant crossover tube hose at the lower rear portion of the coolant crossover tube. Remove any coolant that may have spilled into the engine valley.
- P. Reinstall the alternator support bracket and the four 10mm headed retaining bolts removed earlier. Attach the capacitor resistor removed from the stud bolt on the front cover to one of the 10mm bracket retainers. Route the resistor and its wire away from moving parts.

NOTE: Leave two 10mm headed bolts that attach the bracket to the crossover tube loose.

- Q. Reinstall the Intake Manifold removed in a previous step. Check to see that the rubber intake runner gaskets are in place and undamaged. Make sure the cylinder head surface is clean.
- R. Lower the intake manifold onto the cylinder heads.
- S. Install the ten factory 10mm headed manifold retainers and tighten to factory specifications. Tighten the two 10mm headed bracket bolts that were previously left loose.
- T. Reconnect the IMRC control unit at the rear of the manifold along with the vacuum hose.
- U. Remove the small clips that retain the factory fuel injectors to the fuel rail. Remove the factory fuel injectors and set aside - they will not be reused.
- V. Locate the supplied fuel injectors. Lubricate the injector O-rings with clean motor oil and install into the fuel rail. Reinstall the small retaining clips onto the injectors.
- W. Lower the fuel rail/injector assembly onto the manifold, making sure that the injectors seat properly into the manifold. Secure with the four factory 8mm headed bolts.
- X. Reconnect the fuel injector plugs and all other connections and vacuum lines previously removed from the manifold assembly.

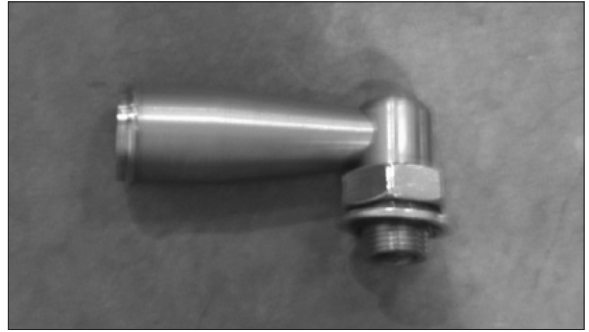

Fig. 5.1-g

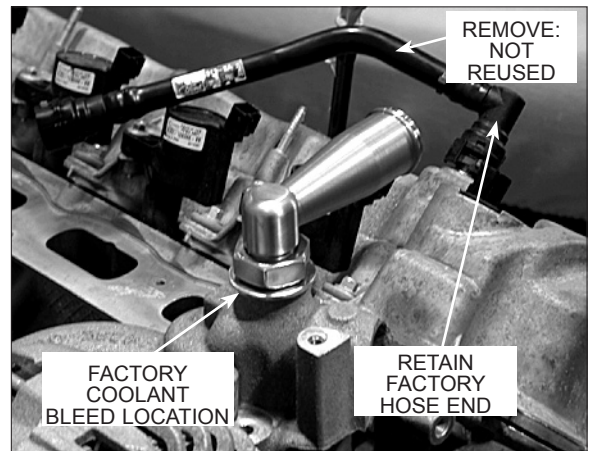

Fig. 5.1-h

5.2 THERMOSTAT HOUSING/RADIATOR HOSE MODIFICATION (2007-2010 Model Year Only)

- A. Using an 8mm socket, remove the two 6mm screws that retain the thermostat housing. Set the housing aside to be reused later. Leave the factory thermostat and O-ring seal in place as they will be reused (*provided they are in good condition*). (See Fig. 5.2-a.)
- B. Locate the supplied thermostat housing adaptor and hardware. Using the two 6mm socket-head screws, install the housing adaptor as shown. (See Fig. 5.2-b.)
- C. Using the 6mm hardware, washers and O-ring provided, reinstall the thermostat housing. Attach the previously removed resistor to the housing as shown. (See Fig. 5.2-c.)
- D. Reinstall the intake manifold removed in a previous step. Check to see that the rubber intake runner gaskets are in place and *undamaged*. Make sure the cylinder head surface is clean.
- E. Lower the intake manifold onto the cylinder heads.
- F. Install the ten factory 10mm headed manifold retainers, and tighten to factory specifications.
- G. Remove the small clips that retain the factory fuel injectors to the fuel rail. Remove the factory fuel injectors and set aside. These will not be reused.
- H. Locate the supplied fuel injectors. Lubricate the injector O-rings with clean motor oil and install into the fuel rail. Reinstall the small retaining clips onto the injectors.
- I. Lower the fuel rail/injector assembly onto the manifold, making sure that the injectors seat properly into the manifold. Secure with the four factory 8mm headed bolts.
- J. Reconnect the fuel injector plugs, all other connections and vacuum lines previously removed from the manifold assembly.
- K. Locate the 4FU114-030 water pipe assembly.

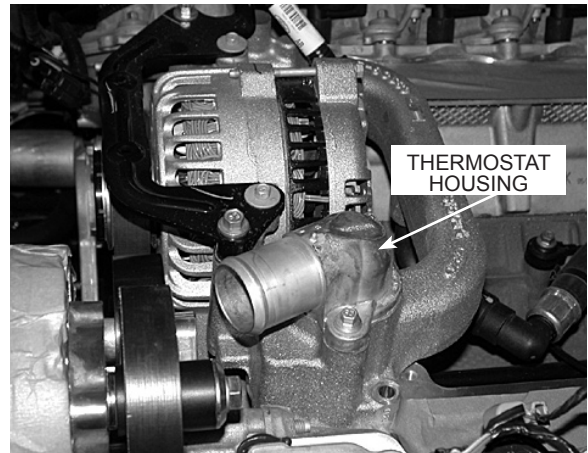

Fig. 5.2-a

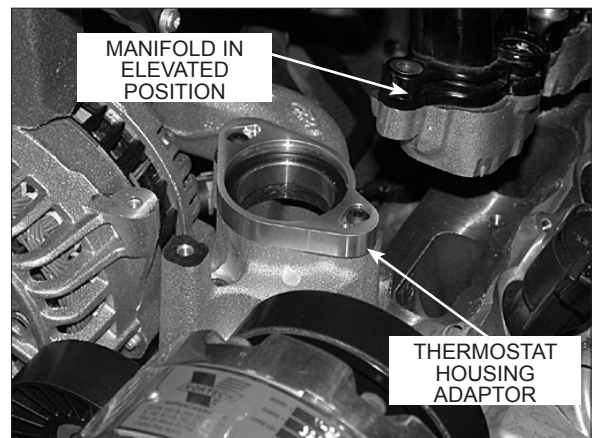

Fig. 5.2-b

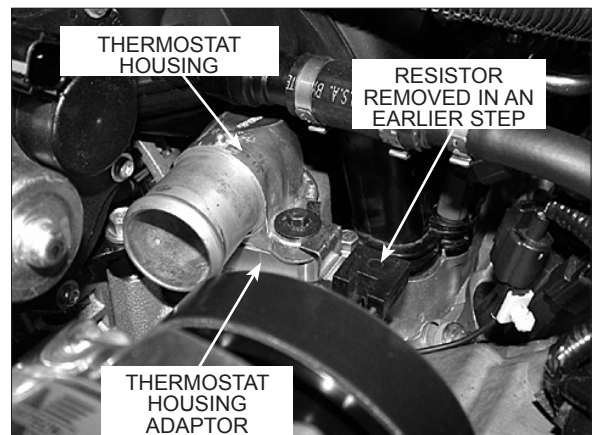

Fig. 5.2-c

5.2 THERMOSTAT HOUSING/RADIATOR HOSE MODIFICATION (2007-2010 Model Year Only), cont'd

- L. Cut approximately 2.25" off the short 90° end of the factory radiator hose and set aside. (See Fig. 5.2-l.)
- M. Cut the remainder of the short 90° bend from the factory radiator hose, approximately half way between the 90° bend and the 45° bend, and discard. (See Fig. 5.2-l.)
- N. Using the 2.25" section of radiator hose cut previously and two #24 hose clamps provided, install the short end of the 90° stainless tube (4FU014-060) onto the repositioned thermostat housing. (See Fig. 5.2-n.)
- O. Slide the protective sleeve provided over the modified hose. Install the remainder of the factory radiator hose using one factory hose clamp and one #24 hose clamp. (See Fig. 5.2-o.)

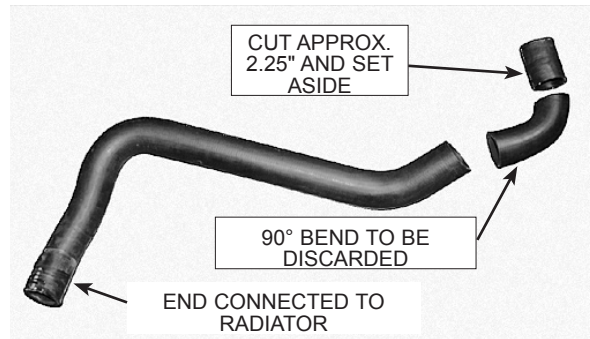

Fig. 5.2-l

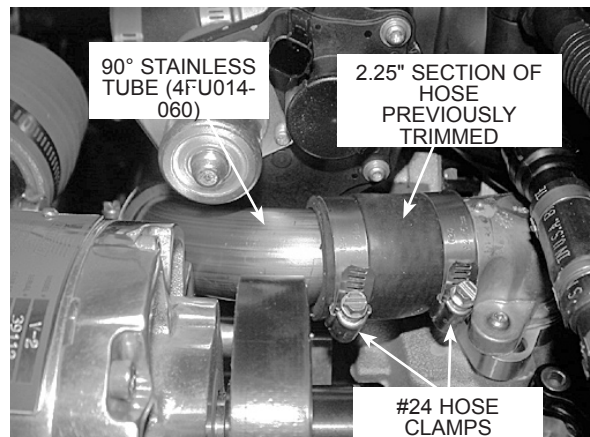

Fig. 5.2-n

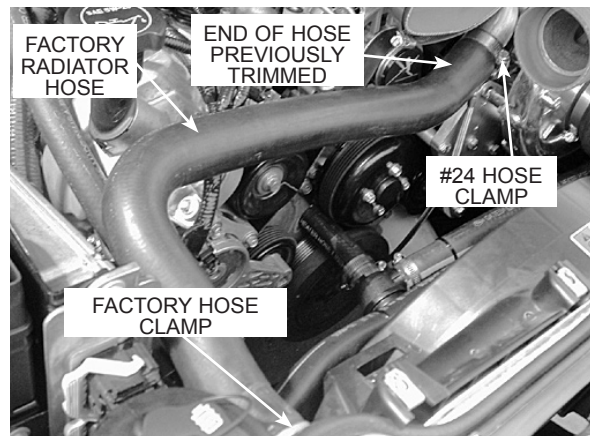

Fig. 5.2-o

6.1 PULLEY AND SPACER REPLACEMENT (Bullitt/V-Power/8-Rib Kits Only - All others skip to step 6.2)

- A. Unplug the cam sensor connector.
- B. Tensioner modification (skip to step c. if installing belt tensioner assist):
1. Remove the three screws retaining the factory spring tensioner to the front of the engine. Remove the factory steel idler from the tensioner and replace with the supplied 3" idler using the factory hardware. (See Fig. 6.1-a.)
 2. Install the three M8 x 40mm bolts w/washers through the tensioner mounting holes.
 3. Slide the three .75"OD x .328"ID x .140" spacers onto the three bolts protruding through the tensioner. (See Fig. 6.1-a.)
 4. Secure the tensioner assembly to the front of the engine. Use Fig. 6.1-a as guide for spacer placement.

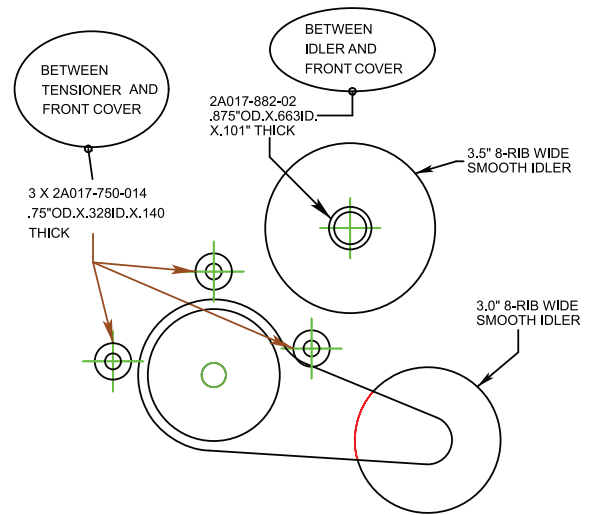

Fig. 6.1-a

6.1 PULLEY AND SPACER REPLACEMENT (Bullitt/V-Power/8-Rib Kits Only - All others skip to step 6.2)

C. OPTIONAL Belt tensioner assist up-grade:

1. Remove the three screws retaining the factory spring tensioner to the front of the engine. Remove the factory steel idler from the tensioner and replace with the supplied 3" idler (4FU116-031) using the factory hardware. (See Fig. 6.1-C1.)
2. Locate the supplied tensioner assist plate. Install the supplied 3/8-16 x 2.5" screw and 3/8-16 jam nut into the plate. Install the three M8 x 55mm bolts w/washers through the plate. Slide the three .75"OD x .328"ID x .927" long spacers onto the previously installed hardware. (See Fig. 6.1-C2.)
3. Install the plate, hardware and spacers onto the factory spring tensioner. Slide the three .75"OD x .328"ID x .140" spacers onto the three bolts protruding through the tensioner. (See Fig. 6.1-C2.)
4. Secure the tensioner assembly to the front of the engine. Use Figs. 6.1-C1, 6.1-C2 as guides for spacer placement.

NOTE: Leave the 3/8" screw and jam nut loose at this time.

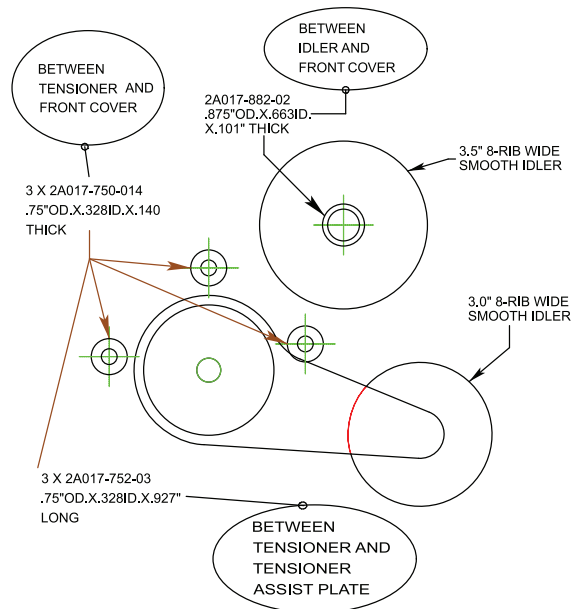

Fig. 6.1-C1 (optional)

- D. Remove the factory idler pulley located just above the spring tensioner location. Replace with the supplied 3.5" idler (4FU016-021) and .875"OD x .663"ID x .101" thick spacer (2A017-882-02) using the factory hardware. (See Fig. 6.1-a.)

E. Replace the alternator pulley:

1. First remove the plastic cap from the end of the alternator pulley to reveal the splined hub.
2. Rotate the pulley so that a round punch can be inserted through the front of the alternator into the alternator-cooling fan. This will hold the alternator assembly from turning. Using the appropriate splined hub tool (see notes on page iv), loosen and remove the alternator pulley. The threads are standard.
3. Install the supplied 8-rib alternator pulley (4FU016-011) and secure using the M16 x 1.50" flanged nut provided.

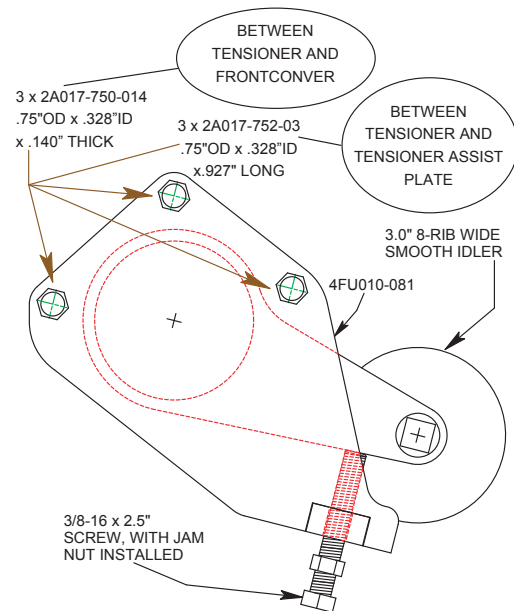

Fig. 6.1-C2 (optional)

6.1 PULLEY AND SPACER REPLACEMENT (Bullitt/V-Power/8-Rib Kits Only - All others skip to step 6.2), cont'd

- F. Remove the two bolts that retain the factory idlers to the front cover. Discard the idlers and bolts. Replace the top idler with the 3.5" smooth idler (4FU016-021) .875"OD x .663"ID x .101" spacer and stud bolt provided. Replace the lower idler with the 3.5" ribbed idler (4FU016-041) .875"OD x .663"ID x .101" spacer and stud bolt provided. (See Fig. 6.1-c.)
- G. Using the appropriate pulley puller, remove the factory power steering pulley and discard. Replace with the supplied 8-rib power steering pulley with the appropriate installer tool.
- H. Remove the A/C clutch retaining screws. Carefully remove the clutch and set aside with the hardware and small spacer located between tip of A/C compressor drive shaft and A/C clutch spline. Replace with the supplied 8-rib A/C pulley (4FR016-021), and secure using the factory hardware and spacer.
- I. Remove the crank pulley retaining bolt. Using the appropriate pulley puller, remove the crank pulley and discard. Install the supplied 8-rib crank pulley using the factory retaining bolt. (Thread locking compound must be applied to the screw threads.)
- J. Loosely install the 8-rib drive belt provided using Fig. 6.1-c for belt route reference. Not all pulleys are installed at this time.

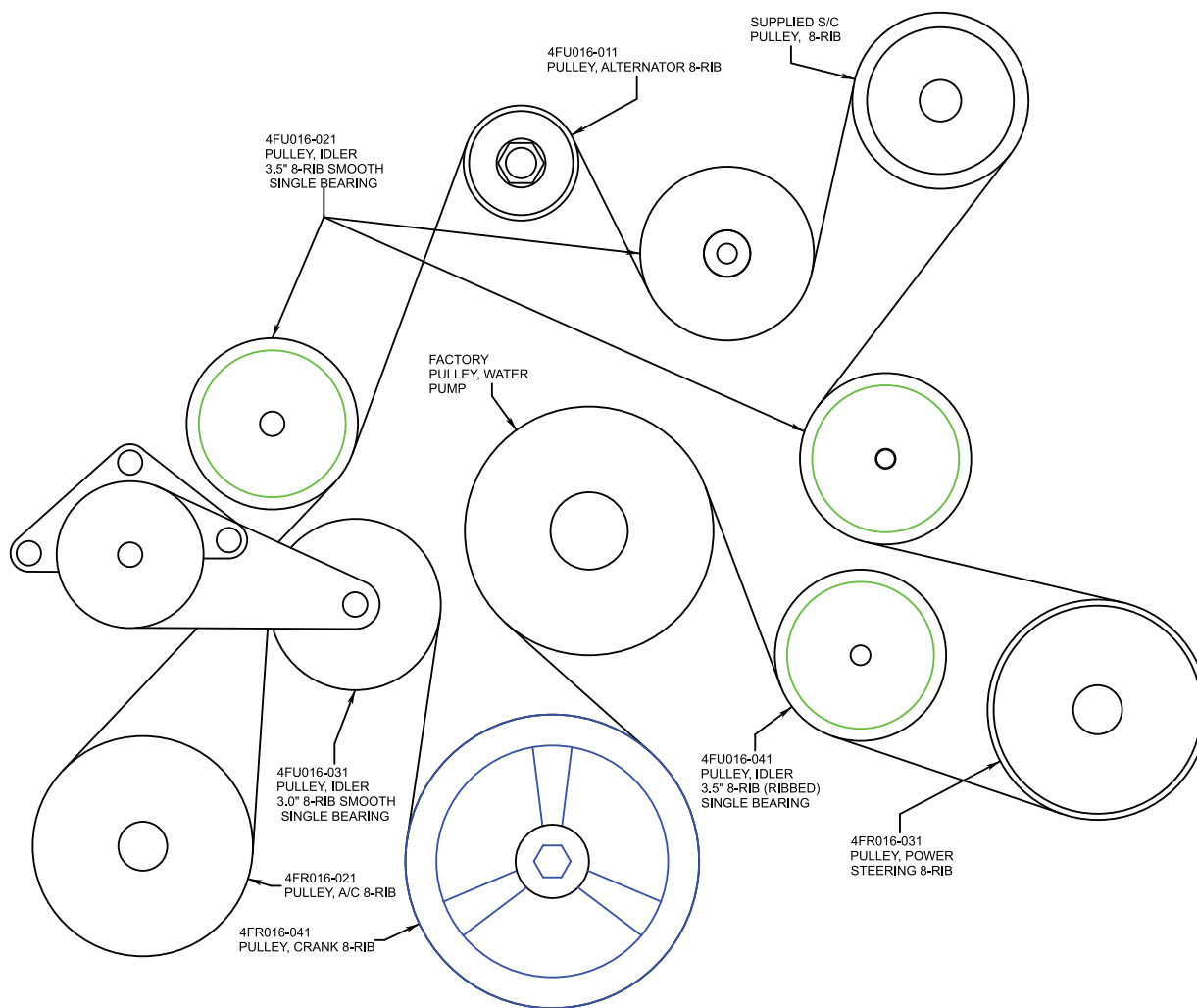

Fig. 6.1-c

6.1 PULLEY AND SPACER REPLACEMENT (Bullitt/V-Power/8-Rib kits Only - All others skip to step 6.2), cont'd

NOTE: See Fig. 6.1-d for the next few steps.

K. S/C mounting plate installation:

1. Install the two 140mm bolts into their mounting plate hole locations and slide the two 2.691" long spacers onto them. (See Figs. 6.1-d, 6.2-a.)
2. Install the idler plate onto the previously installed hardware and spacers.
3. Install the .097" long spacer onto the bolt that will be secured through the alternator. (See Figs. 6.1-d, 6.2-a.)
4. Loosely install the S/C mounting plate assembly using the original S/C mounting plate hardware, taking care to route the drive belt on the correct side of the spacers. (See Figs. 6.2-b, 6.2-c.)
5. Locate the remaining 3.5" smooth idler (4FU017-031), .544" long pilot spacer, and 1.597" long spacer as depicted in Fig. 6.1-d.
6. Install the idler pulley assembly referencing Figs. 6.1-d, 6.2-a.

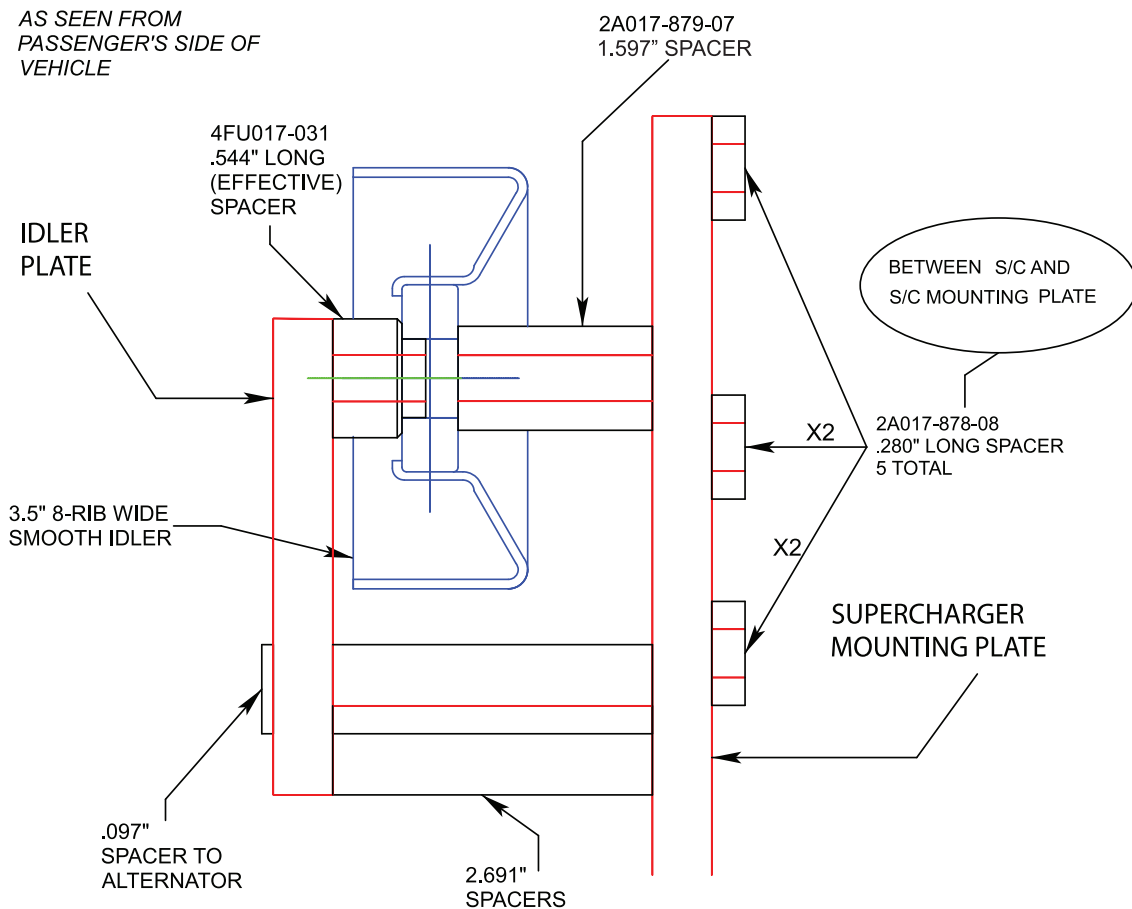

Fig. 6.1-d

6.2 SUPERCHARGER MOUNTING PLATE INSTALLATION

- A. The mounting plate is provided with the spacers and bolts as they would be installed on the vehicle. *Keep these bolts and spacers marked as to their locations.* They are all different in size and mismatching them will result in misalignment of the mounting plate.
- B. (Non V-Power/Bullitt Kits only) Locate the two supplied stud-bolt spacers (see Figs. 6.2-b, 6.2-c) in the S/C mounting plate assembly. Remove the factory screws retaining the idler pulleys on the driver's side of the engine and replace with the stud spacers.
- C. It is necessary to install the supercharger accessory drive belt and loosely route it following Fig. 6.2-c, as not all pulleys are currently in place.
- D. Locate the supercharger mounting plate 4FU010-044 from the supercharger mounting plate assembly. (See Fig. 6.2-a.)
- E. (Non V-Power/Bullitt Kits only) Locate the two 8mm x 140mm long bolts and washers from the mounting bracket assembly and install in the locations noted. (See Fig. 6.2-a.)
- F. Slide the two long spacers onto the bolts previously installed. (See Fig. 6-f.) Install the small triangle-shaped idler pulley mounting bracket to the spacers. Install the .093" spacer onto the bolt that will be attached in the alternator location.
- G. Lower the mounting plate assembly into position on the front of the engine. Be sure to route the drive belt on the correct side of the idler bracket and spacers. (See Fig. 6.2-g.)
- H. Loosely attach the plate using the previously installed 140mm hardware. Locate the two 3/8-16 x 1.0" bolts and washers and install through the plate into the two stud bolt spacers retaining the factory idlers. (See Figs. 6.2-a, 6.2-c.)
- I. Locate the 8mm x 150mm bolt and washer. Loosely install the bolt through the mounting plate and remaining long spacer into the engine cover using Fig. 6.2-a for location reference.
- J. (Non V-Power/Bullitt Kits only) Locate the supplied idler, 1.776" idler spacer, idler pilot spacer, 3/8-16 x 3.75" long bolt and washer. Install the bolt/washer through the mounting plate, 1.776" spacer, supplied idler, idler pilot spacer and into the triangle-shaped bracket. (See Figs. 6.2-f to 6.2-h for assistance.)

NOTE: If installing a standard output kit (non-cooled), the 3/8" x 3.75" bolt will be installed in the upper hole location. H.O. kits install in the lower hole.

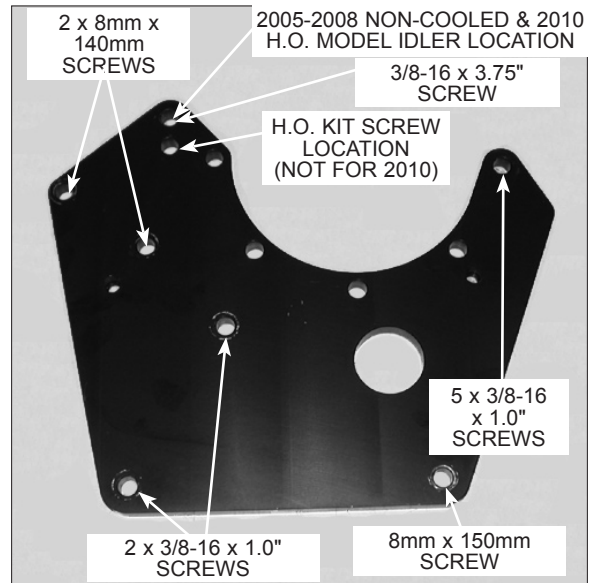

Fig. 6.2-a 2005-2008 NON-COOLED & 2010 H.O. MODEL IDLER LOCATION

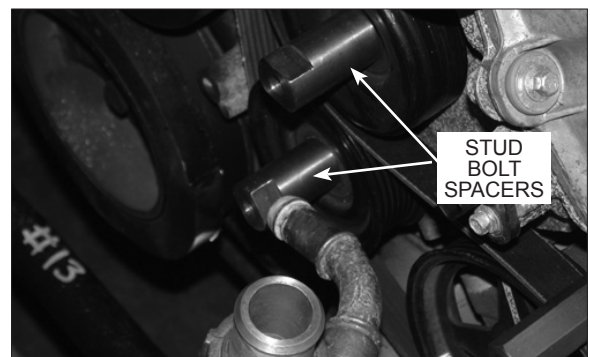

Fig. 6.2-b

NOTE: This figure is just for reference. The small idler pulley mounting bracket will need to be installed at the same time as the supercharger (S/C) Mounting Plate. (See Fig. 7-d.)

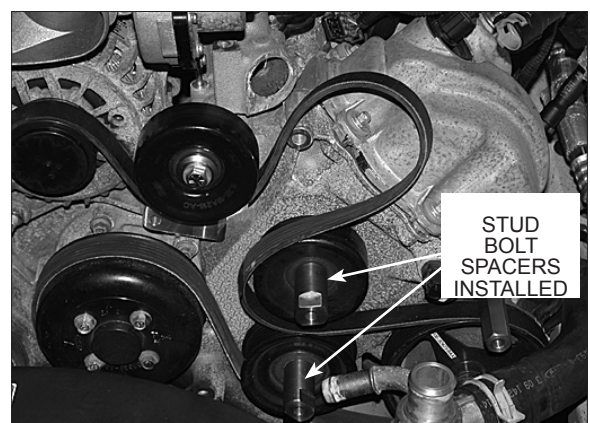

Fig. 6.2-c

6.2 SUPERCHARGER MOUNTING PLATE INSTALLATION, cont'd

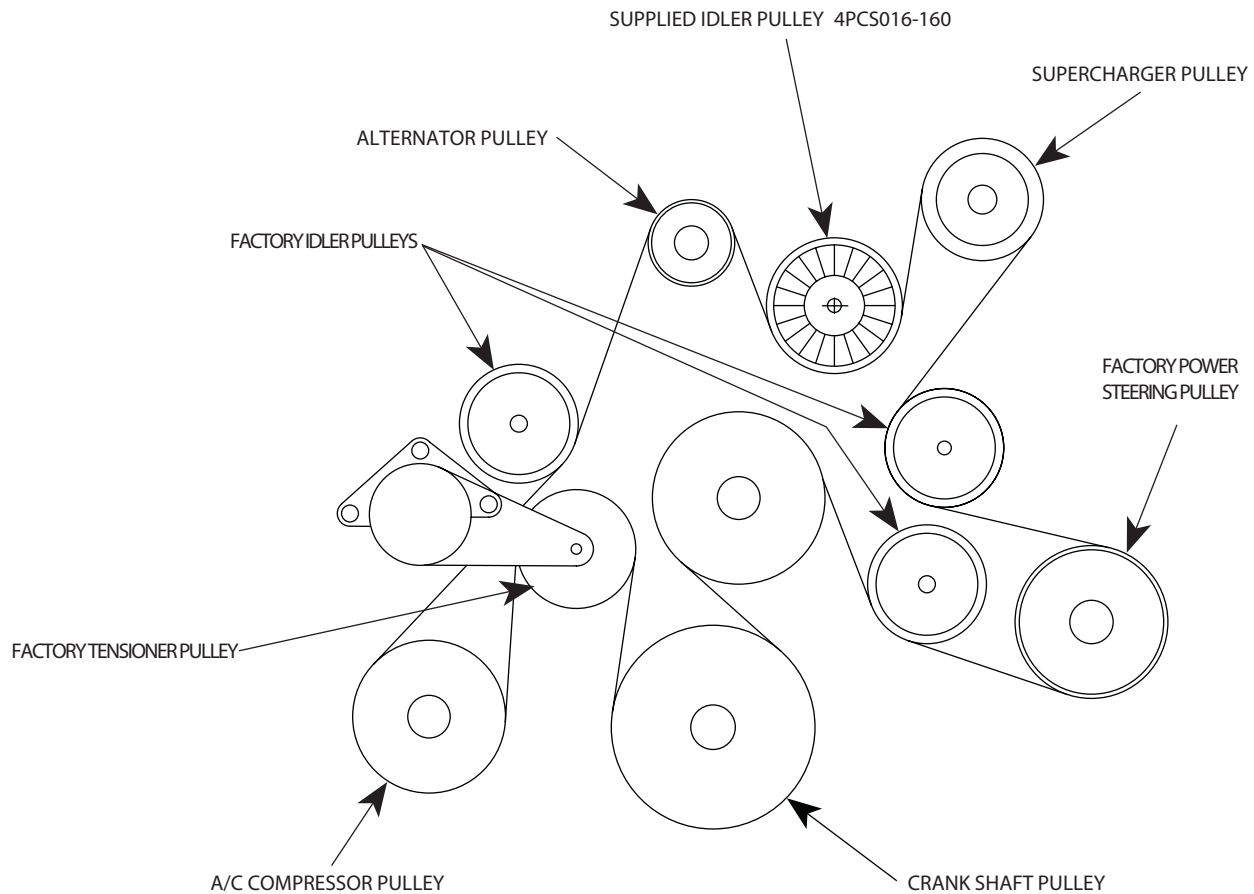

Fig. 6.2-e / Belt routing

6.2 SUPERCHARGER MOUNTING PLATE INSTALLATION, cont'd

- K. Tighten all mounting plate hardware, making sure the drive belt is properly routed and no wiring or hoses are caught between the mounting surfaces. (See Fig. 6.2-g.)
- L1. (Non V-Power/Bullitt Kits only) Install the five 3/8-16 x 1.0" bolts and washers through the back side of the mounting plate. (See Fig. 6.2-h.)
- L2. (V-Power/Bullitt Kits only) Install the five 3/8-16 x 1.5" supplied bolts and washers through the back side of the mounting plate. Install the five .280" long spacers (2A017-878-08) onto the previously installed hardware. (See Fig 6.1-d)
- *M. Attach the supplied length of 1/2" oil drain line hose, and one #8 hose clamp from the previously installed oil drain assembly, to the 1/2" barbed fitting in the supercharger.
- *N. Install the supplied 1/8"NPT x -4 straight fitting from assembly 4FU130-026 to the oil feed fitting on the supercharger.

NOTE: Use only clean engine oil on the pipe threads. Teflon tape or pipe sealant is not recommended as it might loosen and cause blockage of the small oil feed orifice resulting in possible supercharger failure.

- O. Attach the supercharger assembly to the mounting plate using the previously installed hardware. A 9/16" ratcheting end wrench will greatly aid in this step.
- *P. Secure the oil drain hose to the previously installed brass fitting in the oil pan, making sure to route in a smooth *downward* manner and away from moving or hot objects.

NOTE: Any dips, "uphill" sections, kinks or restrictions may cause drainage problems and possible supercharger failure.

- *Q. Attach the -4 oil feed hose to the straight -4 fitting previously installed in the supercharger. Secure away from moving or hot objects.
- R. Using a 1/2" ratchet, rotate the factory spring tensioner clockwise and install the accessory drive belt. (Refer to Fig. 6.2-e for proper belt routing.)
- S. **Optional belt tensioner assist upgrade only:** Once the drive belt has been installed, snug the tensioner assist bolt. Lock in place with the previously installed jam nut.

NOTE: Do not overtension the tensioner assist bolt, as damage may occur to the OEM tensioner..

- T. Reconnect the cam sensor plug.
- **U. Secure the remote drain hose away from the belt and other hoses using tie-wraps

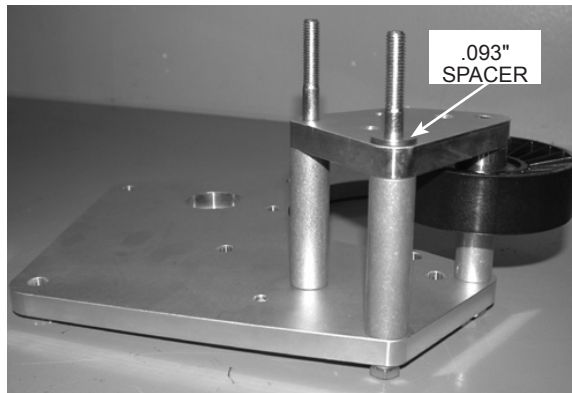

Fig. 6.2-f



Fig. 6.2-g

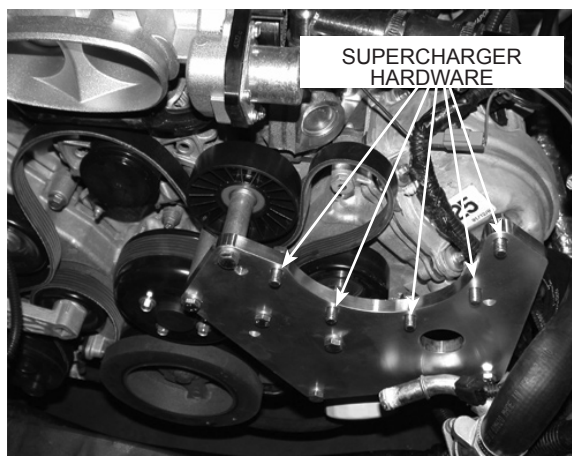

Fig. 6.2-h

* Applies to "engine oil-fed" units only. V-3 applications skip these steps

** Applies to V-3 applications only

7. THERMOSTAT HOUSING RELOCATION (2005-2006 Only)

- A. It will be necessary to relocate the thermostat housing to gain clearance for the supercharger mounting bracket.
- B. Locate hose 7U133-050. This hose will be modified and replace the factory lower radiator hose removed in a previous step. (See *Fig. 7-a*.)
- C. Modify the supplied hose as seen in the figures below. (See *Figs. 7-b, 7-c*.)
- D. Trim approximately 5" off of the 9" end of the hose and 5-1/4" off the 13" end. (See *Fig. 7-c*.)

NOTE: Because of manufacturing tolerances, it is best to leave this hose long and trim to fit.

- E. Install the long end of the modified hose to the outlet of the radiator with a #24 hose clamp. Leave the clamp loose for adjustment.
- F. Install the thermostat housing to the open end of the new, lower radiator hose and the large formed factory hose. Adjust the thermostat's location making sure it clears any moving parts.

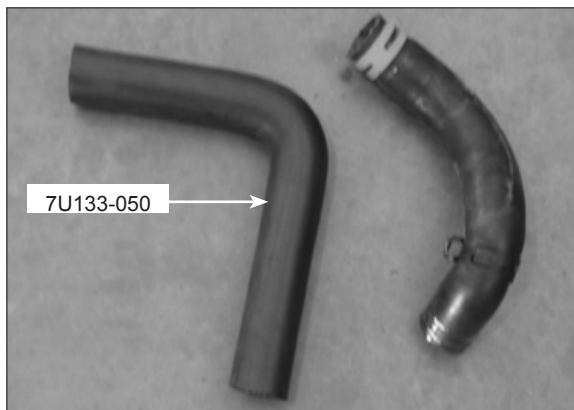

Fig. 7-a

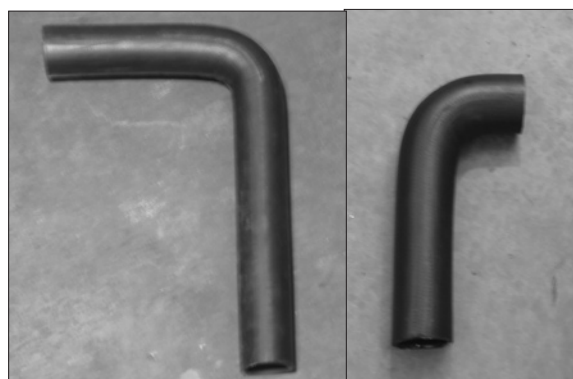

Fig. 7-b

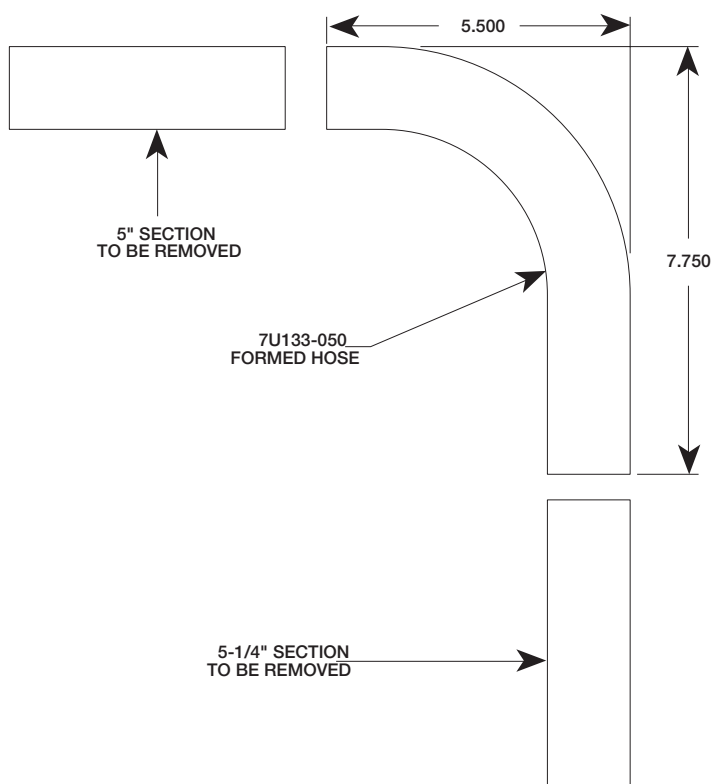

Fig. 7-c

7. THERMOSTAT HOUSING RELOCATION (2005-2006 Only), cont'd

NOTE: The hose clamps will be left loose for adjustment of the thermostat's location until after the installation of the supercharger and supercharger mounting bracket.

- G. Locate the 7U133-190 molded coolant hose. (See *Fig. 7-c.*)
- H. Install the end with the 90° bend onto the thermostat housing.
- I. Install the opposite end to the previously modified coolant crossover tube. Secure using the #20 hose clamps provided. (See *Fig. 7-c.*)



Fig. 7-d

8. CHARGE AIR COOLER INSTALLATION (CHARGE COOLED KITS ONLY)

NOTE: For non-cooled kits skip this section and proceed to Section 9.

A. BUMPER COVER AND SPLASH PAN

1. Raise the vehicle with a floor jack and set on jack stands.
2. Remove the seven 5.5mm headed screws retaining the lower splash panel. (See Fig. 8A-a.)
3. Remove the six Phillips-head screws (*three on each side*) from the lower portions of the plastic inner fender liners. (See Fig. 8A-b.).

On **2010 Models**, remove the four 7mm headed screws (2 per side) from the lower portions of the plastic inner fender liner.

4. Remove the five plastic clips retaining the front portion of the fender liner. Both sides need to be removed. (See Fig. 8A-c.)
5. Remove the four 10mm nuts (*two on each side*) retaining the bumper cover to the fenders. (See Fig. 8A-d.)

2010 models do not use the bracket depicted in Fig.8A-d. Pull outward from rear most portion of the bumper where it attaches to the inner fender to unsnap from retainers. The bumper detaches along the bumper to fender body line and underneath the headlights.

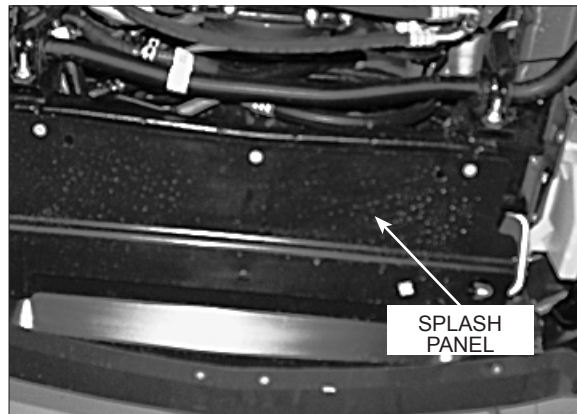

Fig. 8A-a

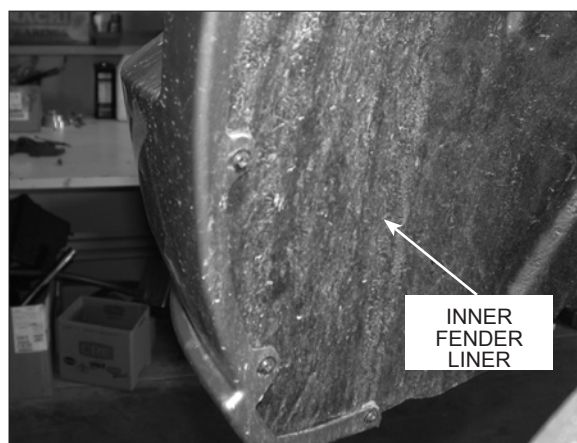

Fig. 8A-b

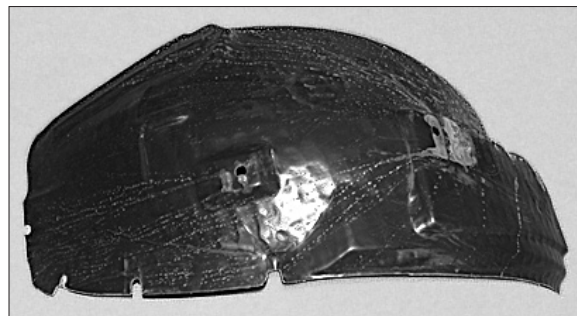

Fig. 8A-c

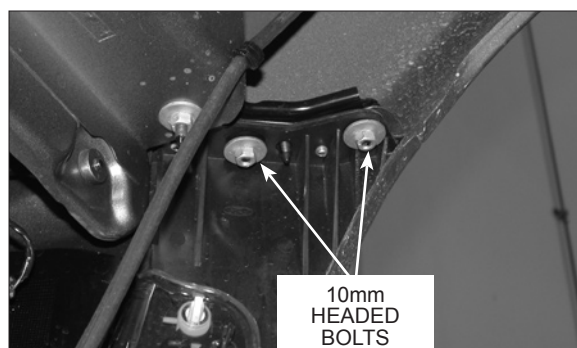

Fig. 8A-d

8. CHARGE AIR COOLER INSTALLATION (CHARGE COOLED KITS ONLY), cont'd

A. BUMPER COVER AND SPLASH PAN, cont'd

6. Disconnect the connectors on the parking and the lower fog lights. (See Fig. 8A-e.)
7. Remove the six nylon clips retaining the upper radiator core support cover. (See Fig. 8A-f.)
8. Remove the two 10mm headed bolts (one on each side in the upper portion of the grill). (See Fig. 8A-g.)

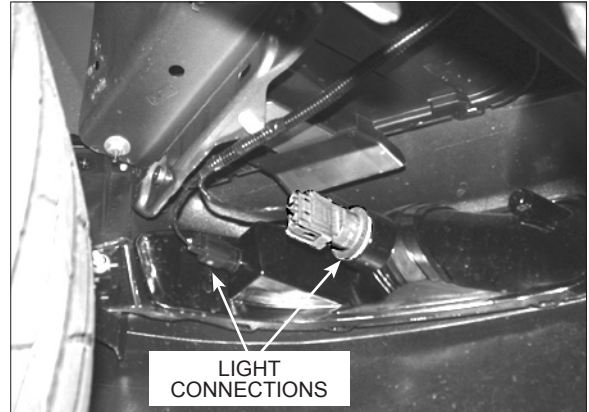

Fig. 8A-e

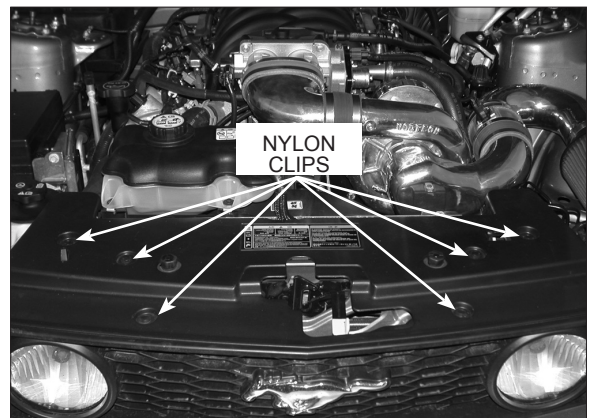

Fig. 8A-f

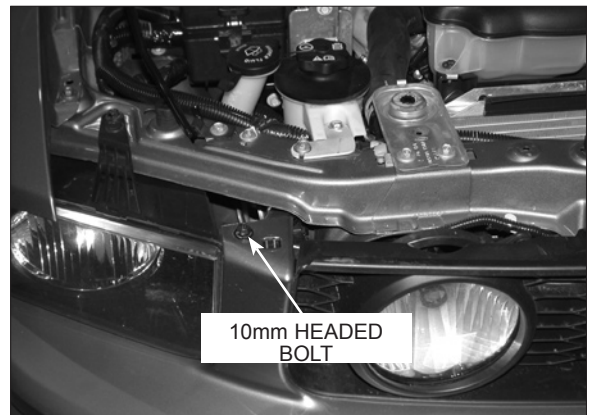

Fig. 8A-g

8. CHARGE AIR COOLER INSTALLATION (CHARGE COOLED KITS ONLY), cont'd

A. BUMPER COVER AND SPLASH PAN, cont'd

9. Lift up on the tabs releasing them from the clips. (See Fig. 8A-h.)
10. Pull out on the bumper cover
11. Remove the connector to the driving light in the grill (if equipped).
12. Remove the bumper cover and set aside. (See Fig. 8A-i.)

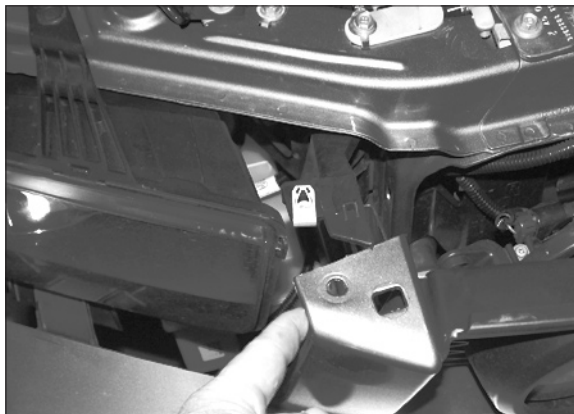

Fig. 8A-h

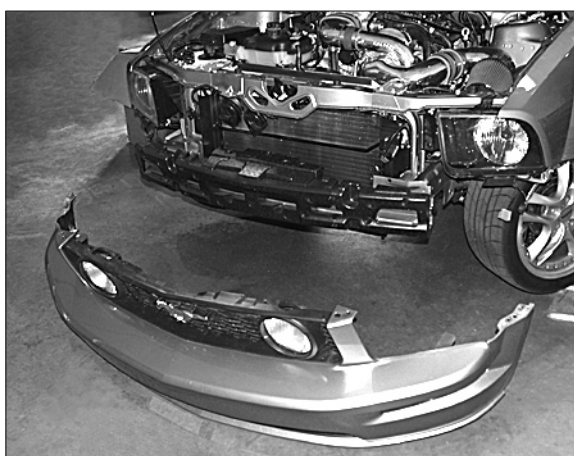

Fig. 8A-i

8. CHARGE AIR COOLER INSTALLATION (CHARGE COOLED KITS ONLY), cont'd

B. WATER COOLER ASSEMBLY INSTALLATION

NOTE: Refer to Fig. 8B-q throughout the following steps:

1. Locate the water cooler assembly 8N106-135.
2. Install the two mounting bracket 8N010-171 and 8N010-173 to the water cooler using the supplied 1/4-20 x 1/2" screws, washers. (See Fig. 8B-a.)

NOTE: Leave these screws loose for adjustment when attaching the assembly to the vehicle.

3. Remove four nylon push pins from the styro-foam bumper support and set the support and the pins aside to be reinstalled. (See Fig. 8B-b.)
4. Remove six of the eight 13mm headed inset bolts retaining the metal bumper support. (See Fig. 8B-c.)
5. **2005-2009 models:** Replace the bolts previously removed with the six 8mm x 1.25" x 35mm long bolts and washers provided.
2010 models: install four M8x1.25x75mm studs into the four inner bumper bolt holes.
6. **2005-2009 models:** Install the four 2A017-036 spacers (*two each side*) onto the bolts that will secure the water cooler. (See Fig. 8B-d.)
2010 models: use four 2A017-753-02 spacers (slightly longer than those depicted in Fig. 8B-d) four 5/16" fender washers, and four nylock nuts

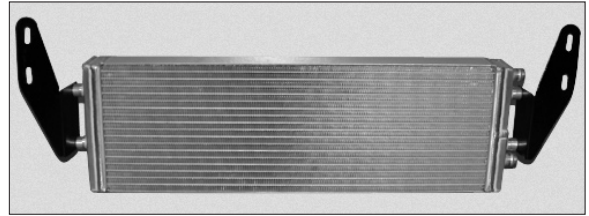

Fig. 8B-a

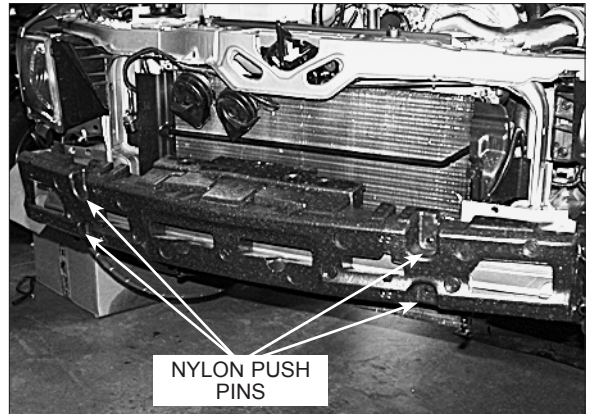

Fig. 8B-b

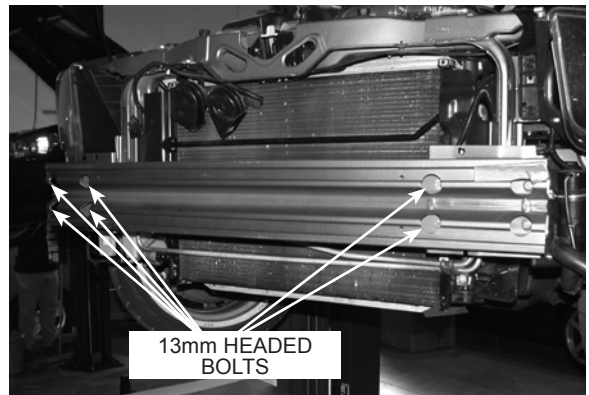

Fig. 8B-c

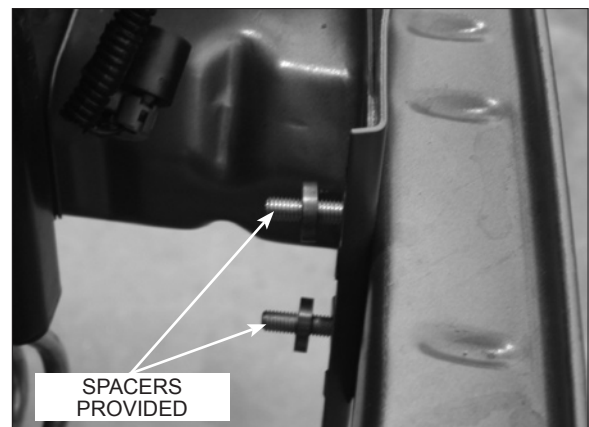

Fig. 8B-d

8. CHARGE AIR COOLER INSTALLATION (CHARGE COOLED KITS ONLY), cont'd

B. WATER COOLER ASSEMBLY INSTALLATION, cont'd

7. Attach the previously assembled water cooler to the bolts and spacers and secure with the 8mm nuts and washers provided. Tighten all cooler hardware at this time. (See *Fig. 8B-e.*)

NOTE: When installing the cooler, make sure that the water ports are configured as shown in Figs. 8B-a, 8B-q. The "top cooler port" must be the highest point on the cooler for proper air purging.

8. Attach the supplied short 90° hose (7U030-065) to the top port on the CAC cooler as shown. (See *Fig. 8B-f.*)
9. Install one of the supplied 3/4" hose unions into the open end of the previously installed 90° hose and secure. (See *Figs. 8B-f, 8B-q.*)

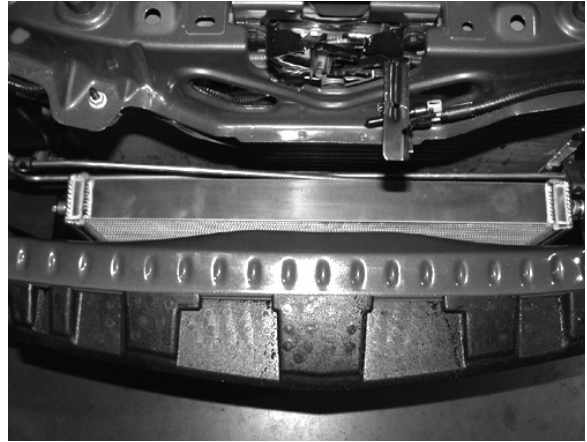

Fig. 8B-e

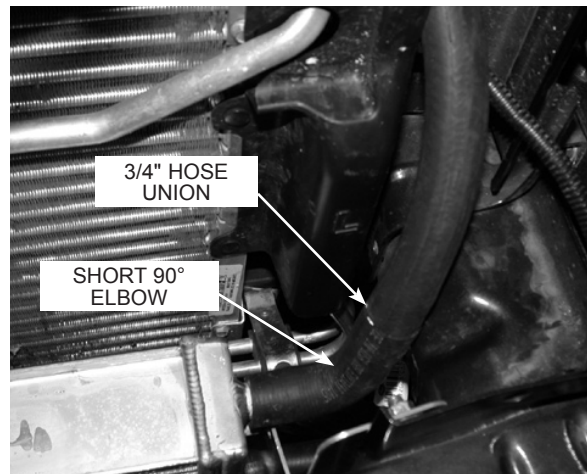

Fig. 8B-f

8. CHARGE AIR COOLER INSTALLATION (CHARGE COOLED KITS ONLY), cont'd

B. WATER COOLER ASSEMBLY INSTALLATION, cont'd

10. **2005-2009 models:** Locate assembly 8N104-125. Confirm that the assembly is complete.
2010 Models: use assembly 8N104-127.
11. Attach the provided ring terminal to the ground wire on the supplied water pump plug harness. Connect the supplied length of 16GA wire to the positive wire using the supplied butt connector. Connect the water pump harness to the water pump.
12. Locate the supplied water pump (8F001-403), two 2-3/8" adel clamps, and water pump mounting bracket. Place the adel clamps on the water pump. Using the supplied 1/4-20 hardware, secure the water pump and clamps to the mounting bracket. When installing, attach the water pump ground wire to one of the water pump mounting clamps using the previously installed ring terminal. (See Fig. 8B-g.)
2010 Models: use water pump bracket depicted in Fig. 8B-g2.
13. Attach the pump assembly to the two 8mm x 35mm long bolts previously installed and secure using the 8mm nuts and washers provided. (See Fig. 8B-h.)
2010 Models: see Fig. 8B-h2

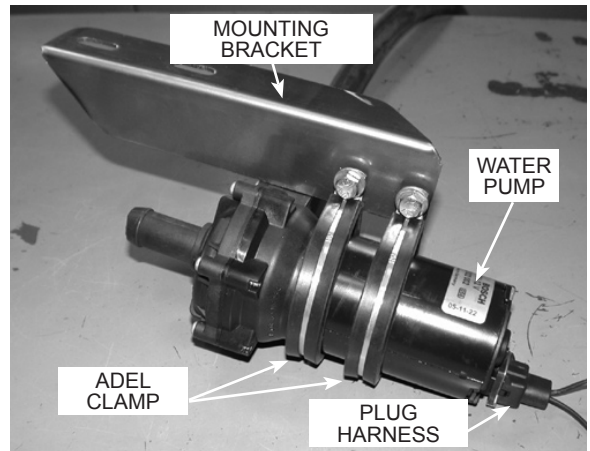

Fig. 8B-g

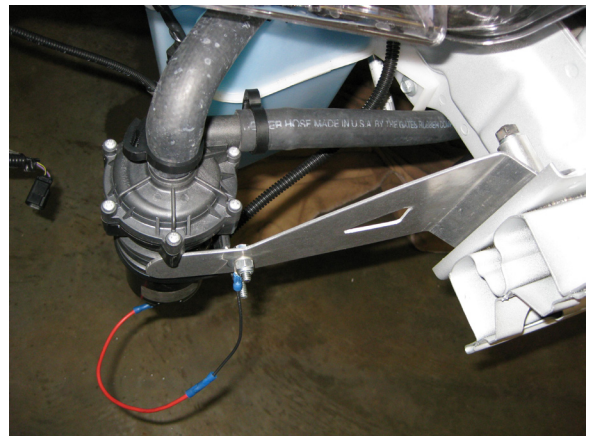

Fig. 8B-g2 (2010 Models)



Fig. 8B-h2 (2010 Models)

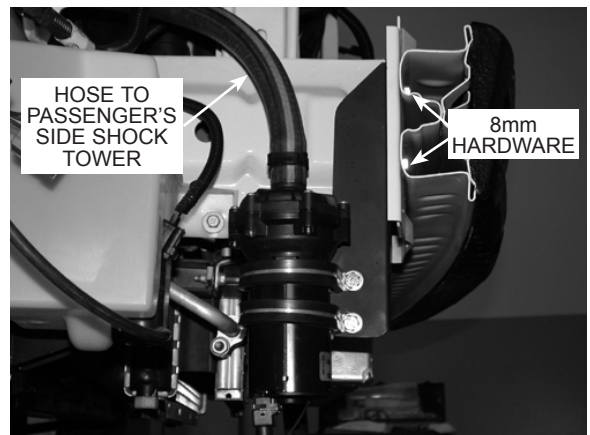

Fig. 8B-h (2005-2009 Models)

8. CHARGE AIR COOLER INSTALLATION (CHARGE COOLED KITS ONLY), cont'd

B. WATER COOLER ASSEMBLY INSTALLATION, cont'd

14. Route the positive wire up towards the driver's side valve cover.
15. Locate the ballast resistor plug. Install the supplied T-tap connector, cut the water pump positive wire (*from the water pump*) for best fit, attach the supplied male spayed connector and attach to the wire T-tap connector. (See *Fig., 8B-i.*)
16. Cut the water pump positive wire and install the inline fuse holder and fuse. Install the wire loom provided and secure away from heat and moving parts. (See *Fig. 8B-i.*)

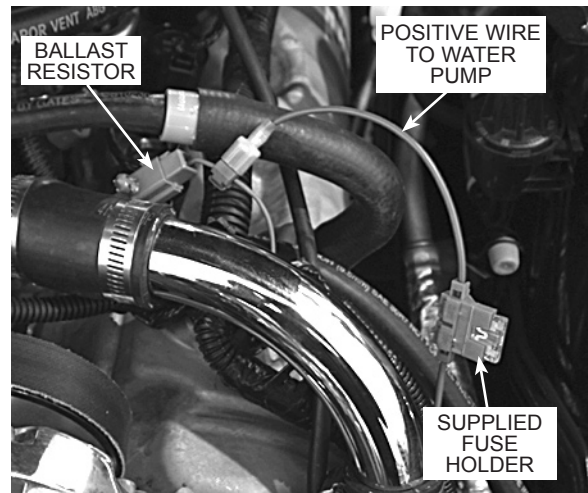

Fig. 8B-i

8. CHARGE AIR COOLER INSTALLATION (CHARGE COOLED KITS ONLY), cont'd

B. WATER COOLER ASSEMBLY INSTALLATION, cont'd

17. Locate the 3/4" x 150° molded rubber hose (7U038-150). Connect the short end of the 3/4" x 150° hose to the lower port on the previously installed water cooler. Install one of the provided 3/4" hose unions into the open end of the 150° hose. Attach a length of 3/4" hose approximately 24" between the hose union and the previously installed water pump discharge. Secure all hose connections using the nylon ratchet clamps provided. (See Fig. 8B-j.)

2010 models will require the passenger side air diverter to be trimmed where the power steering cooler line passes through. Enlarge the bottom of this notch 1-1/2" for 3/4" hose to pass through

18. Attach a length of 3/4" hose approximately 48" long to the previously installed water pump feed port and secure. Route the open end of the installed hose toward the passenger's side shock tower. This hose will be connected in later step. (See Fig. 8B-h.)

NOTE: The installation of this hose section should maintain an "uphill" routing without dips or kinks.

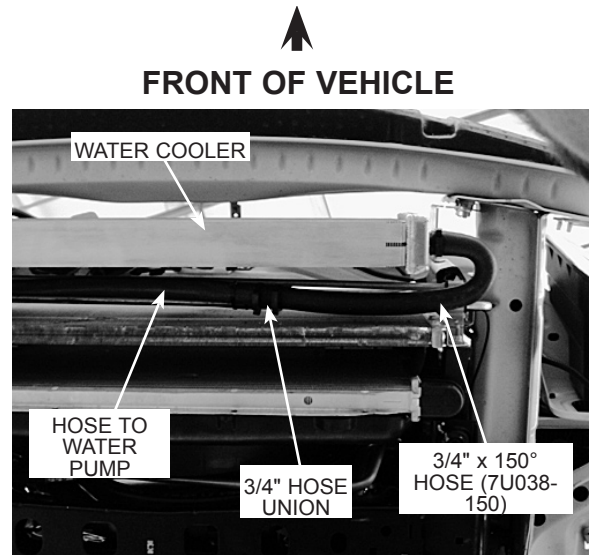

Fig. 8B-j | Viewed From Below

8. CHARGE AIR COOLER INSTALLATION (CHARGE COOLED KITS ONLY), cont'd

B. WATER COOLER ASSEMBLY INSTALLATION, cont'd

19. Assemble the surge tank reservoir 8N056-060 install a 1/2"NPT x 3/4" straight barbed fitting in the bottom of the surge tank and one 1/2"NPT x 3/4" x 90° in the side. (See Fig. 8B-k.)
20. Locate and attach the surge tank mounting bracket 8N010-160. Attach the bracket with two 1/4-20 x 1/2" socket head cap screws and washers. (See Fig. 8B-l.)

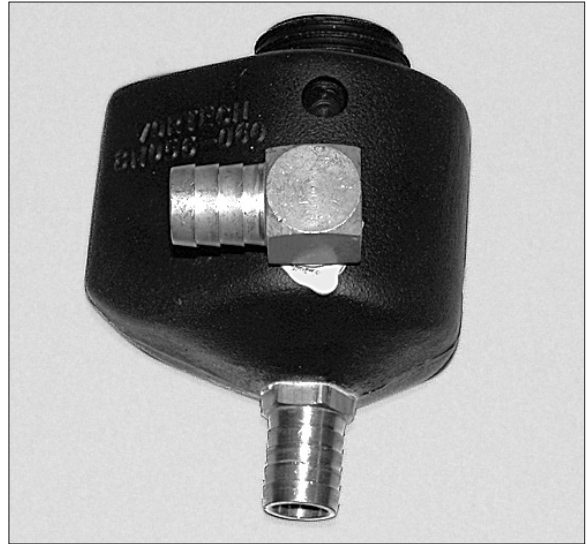

Fig. 8B-k

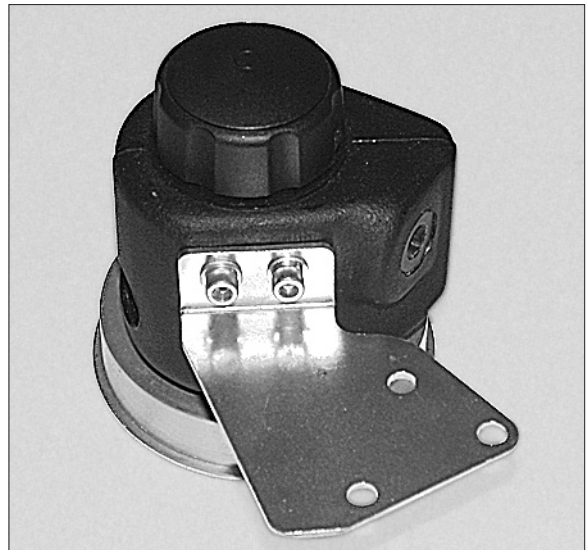

Fig. 8B-l

8. CHARGE AIR COOLER INSTALLATION (CHARGE COOLED KITS ONLY), cont'd

B. WATER COOLER ASSEMBLY INSTALLATION, cont'd

21. On the passenger's side of the engine, attached to the valve cover, is a large wire harness. The harness will have to be relocated to gain clearance for the surge tank and the radiator overflow reservoir. (See Figs. 8B-n, 8B-m.)
22. Detach the wiring harness from the retaining clips and move the harness to the shock tower. Secure the harness to the A/C line with wire ties. (See Fig. 8B-n.)
23. Remove the small clip retaining the small wiring harness to the shock tower. (See Fig. 8B-n.)
24. Attach the small harness to the large harness with wire ties.
25. To gain clearance for the coolant reservoir, the A/C line will need to be bent slightly towards the passenger's side fender. (See Fig. 8B-n.)

NOTE: A/C line is under high pressure. Use caution not to kink or damage the line.

(2005-2006 Only)

26. Remove the 10mm headed screw retaining the ground strap to the bracket on the strut tower. (See Fig. 8B-o.)



Fig. 8B-m



Fig. 8B-n

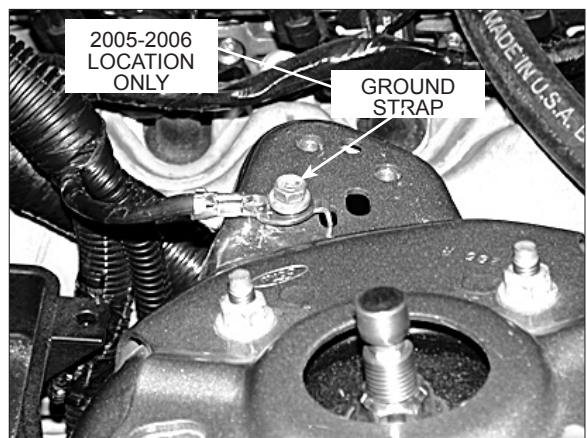

Fig. 8B-o

8. CHARGE AIR COOLER INSTALLATION (CHARGE COOLED KITS ONLY), cont'd

B. WATER COOLER ASSEMBLY INSTALLATION, cont'd

27. Attach the 3/4" hose previously installed to the straight 1/2"NPT x 3/4" barb at the bottom of the surge tank reservoir. Secure with a nylon clamp. (See Fig. 8C-p.)



Fig. 8B-p

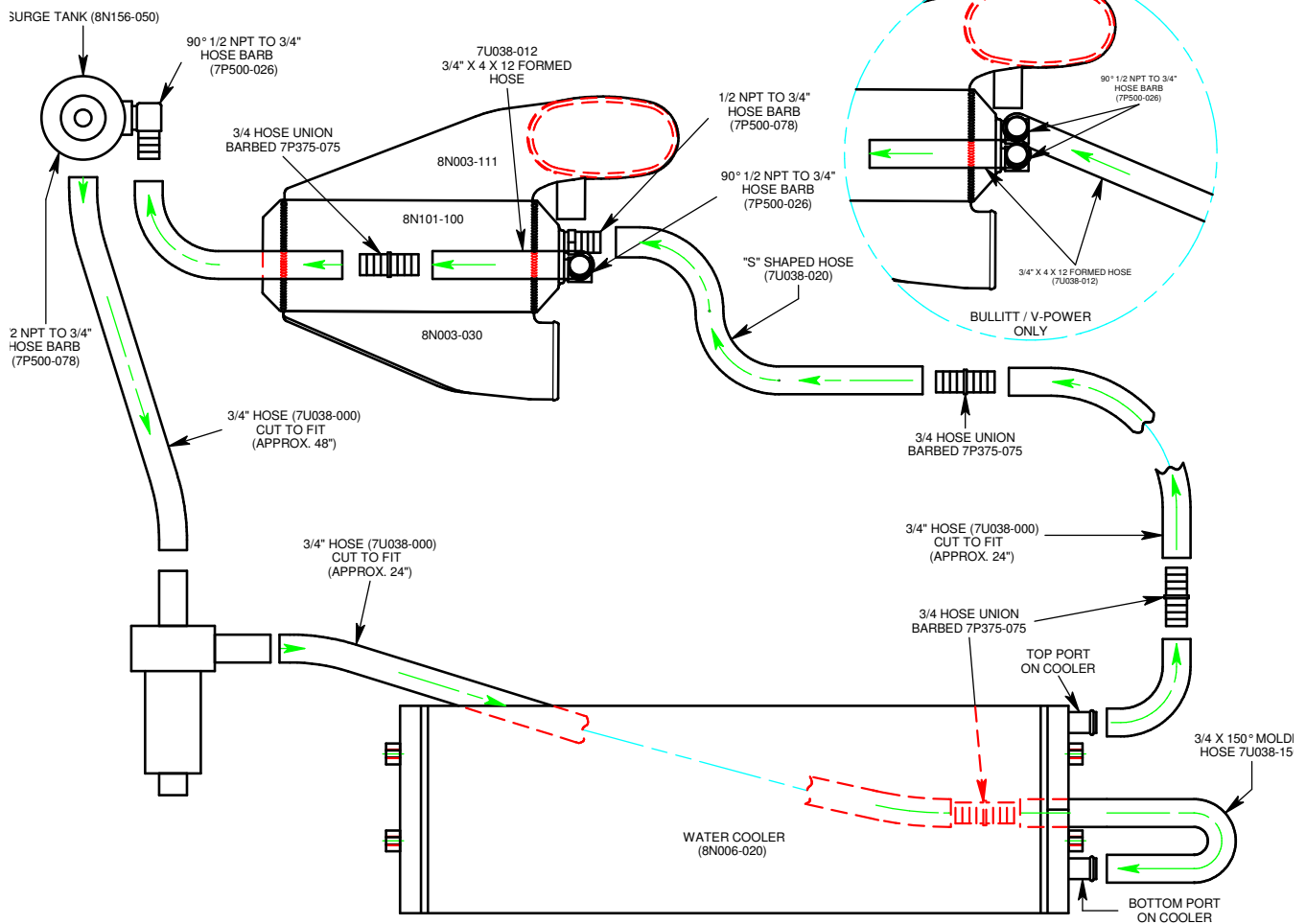

Fig. 8B-q

8. CHARGE AIR COOLER INSTALLATION (CHARGE COOLED KITS ONLY)

C. ENGINE COOLANT RESERVOIR INSTALLATION (2005-2006 Models Only)

NOTE: For 2007-2010 models skip to Section 8.E.

1. Locate assembly 8N155-080.
2. Attach the rear reservoir mounting bracket 4FU010-051 to the reservoir with the 1/4-20 x 1/2" long bolts and washers provided. (See Fig. 8C-a.)
3. Attach bracket 4FU010-061 to the front of the reservoir with the hardware provided. (See Fig. 8C-b.)
4. Locate and install 1/4"NPT x 3/8" barbed fitting in the tapped hole just above the previously installed mounting bracket. This hole may have to be opened using the appropriate drill bit. (See Fig. 8C-c.)



Fig. 8C-a

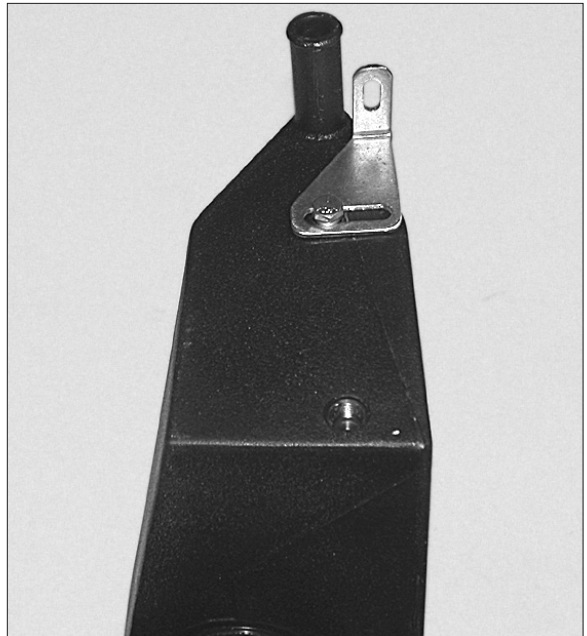

Fig. 8C-b

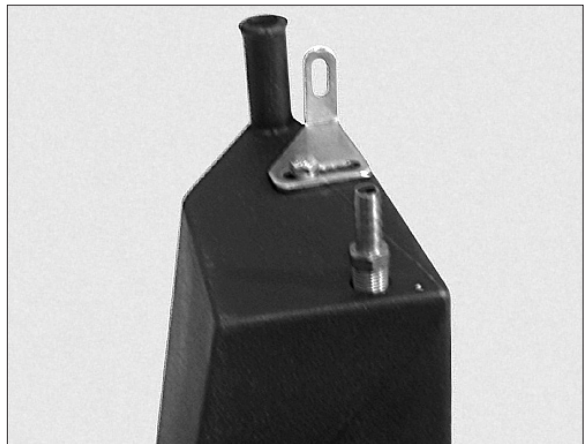

Fig. 8C-c

8. CHARGE AIR COOLER INSTALLATION (CHARGE COOLED KITS ONLY), cont'd

C. ENGINE COOLANT RESERVOIR INSTALLATION (2005-2006 Models Only), cont'd

5. Remove the 10mm headed bolt that secures the back of the ECU and the power distribution box. (See Fig. 8C-d.)
6. Install the coolant reservoir. Secure the front of the reservoir with the factory fastener removed previously. (See Fig. 8C-e.)

NOTE: Leave this bolt loose for final adjustment in a later step.

7. Attach the rear mounting bracket with the surge tank mounting bracket to the strut tower with the 6mm x 20mm long screws and washer provided. (See Fig. 8C-f.)

NOTE: Reinstall the factory ground wire with one of the 6mm screws and washers.

8. Attach a length of 3/4" hose (approximately 3' long) to the 3/4" bung on the front of the coolant reservoir. Route the hose to the 3/4" outlet on the thermostat housing secure the hose with the clamps provided. (See Fig. 8C-g.)

NOTE: A/C line on the passenger side must be bent away from block for reservoir clearance. This can be done with a large screwdriver as depicted in figure 8C-g2.

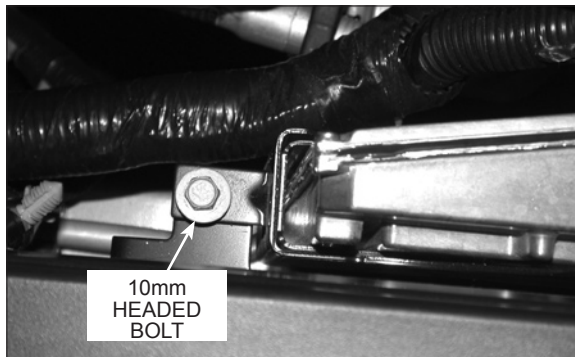

Fig. 8C-d

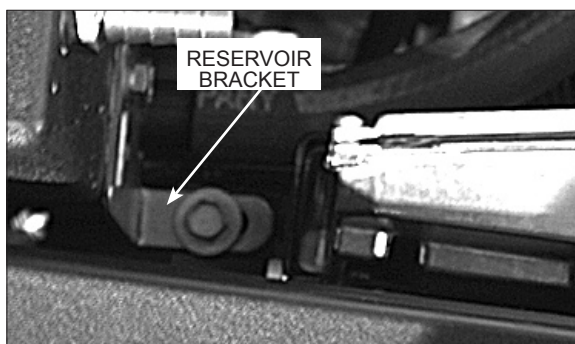

Fig. 8C-e

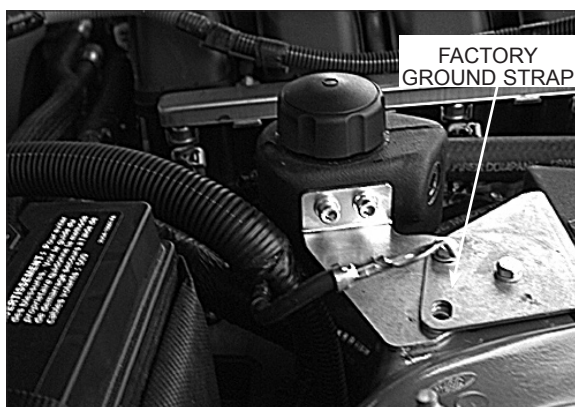

Fig. 8C-f



Fig. 8C-g2



Fig. 8C-g

8. CHARGE AIR COOLER INSTALLATION (CHARGE COOLED KITS ONLY), cont'd

C. ENGINE COOLANT RESERVOIR INSTALLATION (2005-2006 Models Only), cont'd

9. Modify the small hose removed from the factory coolant overflow reservoir. By cutting the "S" bend off the hose end. (See Fig. 8C-h.)
10. Install a 3/8" union and a #17 stepless clamp. Secure the clamp. Using a length of 3/8" (approximately 40" long) hose that is provided, secure the hose to the union with a #17 stepless clamp. (See Fig. 8C-i.)
11. Route the overflow hose across the radiator and under the radiator retaining bracket to the 1/4"NPT x 3/8" hose barb fitting in the coolant reservoir securing with a clamp. (See Fig. 8C-j.)



Fig. 8C-h



Fig. 8C-i



Fig. 8C-j

8. CHARGE AIR COOLER INSTALLATION (CHARGE COOLED KITS ONLY), cont'd

D. RADIATOR HOSE MODIFICATIONS ('05-'06 Models Only)

1. Remove the passenger's side upper radiator hose. (See *Fig. 8D-a.*)
2. Modify the upper hose by cutting the hose just after the bend. (See *Fig. 8D-b.*)
3. Attach the hose to the formed stainless tube 4FU014-010 with a #24 hose clamp.
4. A section of 1-1/2"ID hose left from the coolant tube relocation will be cut to approximately 2-3/4" long and attached to the outlet of the radiator reusing the factory spring clamp to secure the hose to the outlet.
5. Install the formed coolant tube to the inlet on the engine and to the radiator. Secure with hose clamps. (See *Fig. 8D-c.*)



Fig. 8D-a



Fig. 8D-b



Fig. 8D-c

8. CHARGE AIR COOLER INSTALLATION (CHARGE COOLED KITS ONLY), cont'd

E. ENGINE COOLANT RESERVOIR INSTALLATION (2007-2010 Models Only)

1. Locate assembly 8N155-082.
2. Attach the rear reservoir mounting bracket 4FU010-091 to the reservoir with the 1/4-20 x 1/2" long bolts and washers provided. (See Fig. 8E-a.)
3. Attach bracket 4FU010-061 to the front of the reservoir with the hardware provided. (See Fig. 8E-b.)
4. Locate and install 1/4"NPT x 3/8" barbed fitting in the tapped hole just above the previously installed mounting bracket. This hole may have to be opened using the appropriate drill bit. (See Fig. 8E-c.)

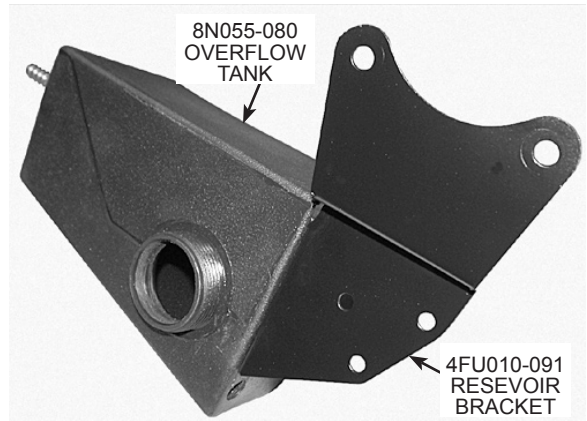

Fig. 8E-a



Fig. 8E-b

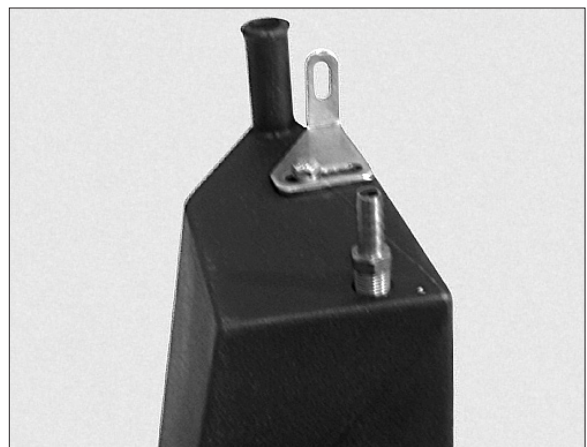

Fig. 8E-c

8. CHARGE AIR COOLER INSTALLATION (CHARGE COOLED KITS ONLY), cont'd

E. ENGINE COOLANT RESERVOIR INSTALLATION (2007-2010 Models Only), cont'd

5. Remove the 10mm headed bolt that secures the back of the ECU and the power distribution box. (See Fig. 8E-d.)
6. Install the coolant reservoir. Secure the front of the reservoir with the factory fastener removed previously. (See Fig. 8E-e.)

NOTE: Leave this bolt loose for final adjustment in a later step.

- 7.1 Attach the rear mounting bracket with the surge tank mounting bracket to the strut tower using the factory strut mounting hardware. (See Fig. 8E-f.)
- 7.2 (Bullitt Only) Attach bracket 4FU010-061 on the underside of the 4FU010-091 reservoir bracket to ensure clearance from strut tower brace.
8. Attach a length of 3/4" hose (approximately 22" long) to the 3/4" bung on the front of the coolant reservoir. Secure using one of the #10 hose clamps provided. Route the open end of the hose to the 1" hose previously connected to the factory coolant reservoir. Connect and secure the two hoses using the 3/4" x 1" hose union, the factory 1" spring clamp and the #10 hose clamp provided.

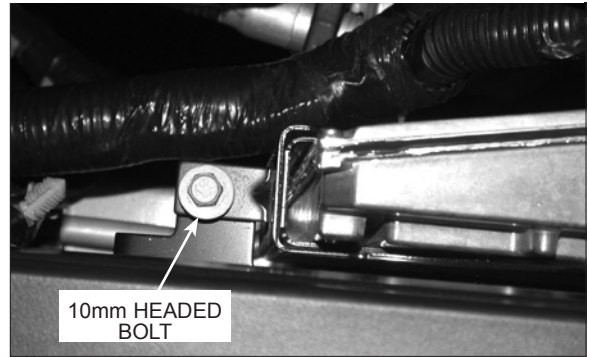

Fig. 8E-d

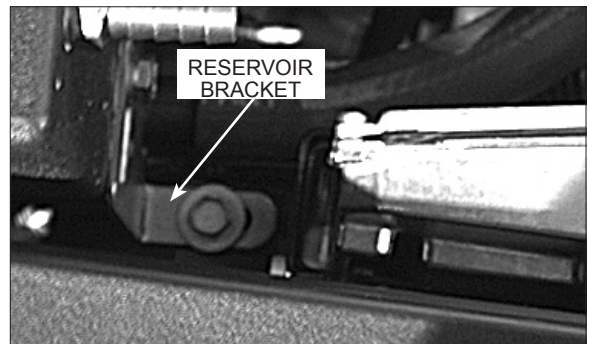

Fig. 8E-e

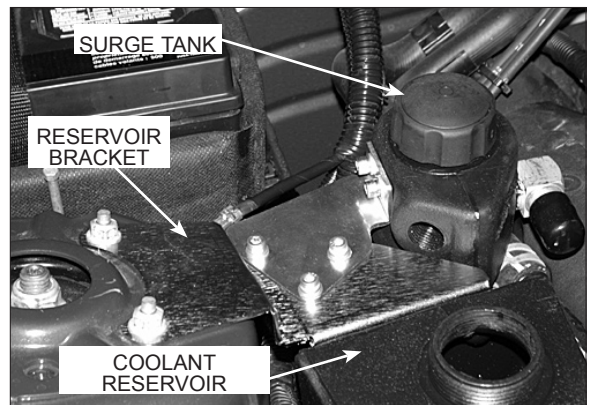

Fig. 8E-f

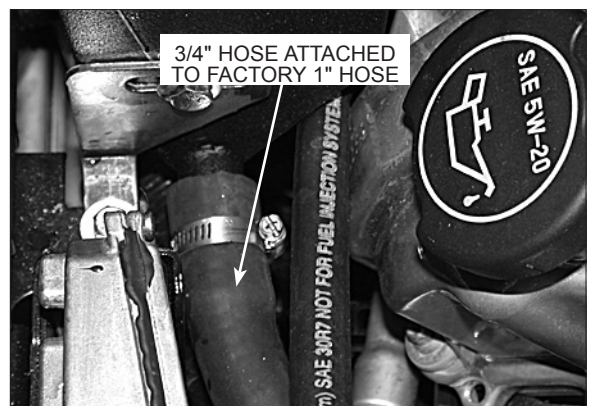

Fig. 8E-g

8. CHARGE AIR COOLER INSTALLATION (CHARGE COOLED KITS ONLY), cont'd

E. ENGINE COOLANT RESERVOIR INSTALLATION (2007-2010 Models Only), cont'd

9. Modify the small hose removed from the factory coolant overflow reservoir. By cutting the "S" bend off the hose end. (See Fig. 8E-h.)
10. Install a 3/8" union and a #17 stepless clamp. Secure the clamp. Using a length of 3/8" (approximately 40" long) hose that is provided, secure the hose to the union with a #17 stepless clamp. (See Fig. 8E-i.)
11. Route the overflow hose across the radiator and under the radiator retaining bracket to the 1/4"NPT x 3/8" hose barb fitting in the coolant reservoir securing with a clamp. (See Fig. 8E-j.)



Fig. 8E-h



Fig. 8E-i



Fig. 8E-j

8. CHARGE AIR COOLER INSTALLATION (CHARGE COOLED KITS ONLY), cont'd

F. COOLER CORE INSTALLATION

1. Locate the charge air cooler assembly.
2. Attach the 4.5" x 2" sleeve to the throttle body and secure with a #72 hose clamp.
- 3.a (Non-V-Power/Bullitt Kits only) Install the 1/2"NPT x 3/4" barb 90° and straight fittings into the charge cooler as shown. (See Fig. 8F-a.)
- 3.b (V-Power/Bullitt Kits only) Install the two 1/2" NPT x 3/4" barb 90° fittings into the charge cooler as shown (See Fig. 8F-b)
4. Attach the long end of the 2.75" (3" if V-Power) silicone elbow to the cooler inlet and loosely install a #44 (#48 on V-Power cars) hose clamp. The open end of the elbow should be facing up as it will be attached to the supercharger discharge.
5. Lower the cooler assembly into position. Attach the open end of the previously installed 2.75" elbow to the supercharger discharge and loosely install a #44 hose clamp.
6. Attach the cooler discharge to the previously installed sleeve on the throttle body. Secure with a #72 hose clamp.
7. Tighten all cooler clamps at this time.
8. Locate one of the remaining 3/4" molded 90°. Trim approximately 5" from the long end and attach the short end to the forward most 3/4" x 90° fitting previously installed in the cooler. Secure with the nylon ratchet clamp provided.
9. Install a 3/4" hose union into the open end of the previously installed hose. Attach a section of 3/4" hose approximately 32" long to the union. Route the open end of the hose to the surge tank. Using the remaining adel clamp and factory hardware, secure the hose to the factory coolant reservoir mounting location. (See Figs. 8B-q, 8F-c for assistance.) Secure all hose connections with the supplied nylon ratchet clamps.
- 10a. (Non-V-Power/Bullitt Kits only) Locate the supplied "S" shaped hose. Trim approximately 1" from the short end and attach it to the straight fitting previously installed in the cooler. Install a 3/4" hose union into the open end of the "S" hose. Attach a section of 3/4" hose approximately 24" long to the union and route to the driver's side and down to the water cooler. Trim for best fit and connect to the 3/4" hose union previously installed in the 90° short rubber hose attached to the top water port on the CAC cooler.

NOTE: The installation of this hose section should maintain an "uphill" routing without dips or kinks.

- 10b (V-Power/Bullitt Kits only) Locate the remaining 3/4" molded 90° hose and install on the rear most 3/4" x 90° fitting previously installed in the CAC. Secure with the nylon ratchet clamp provided. Trim as required. Using the supplied 3/4" barb union connect the other end of the molded 90° hose to a section of 3/4" hose approximately 24" long routed to the driver side and down to the top of the water cooler. trim for best fit and connect to the 3/4" hose union previously installed in the 90° short rubber hose attached to

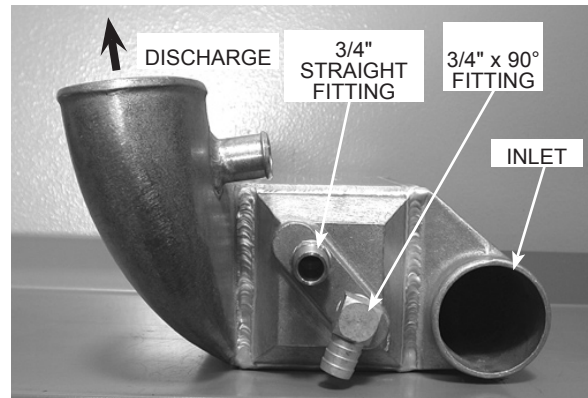

Fig. 8F-a

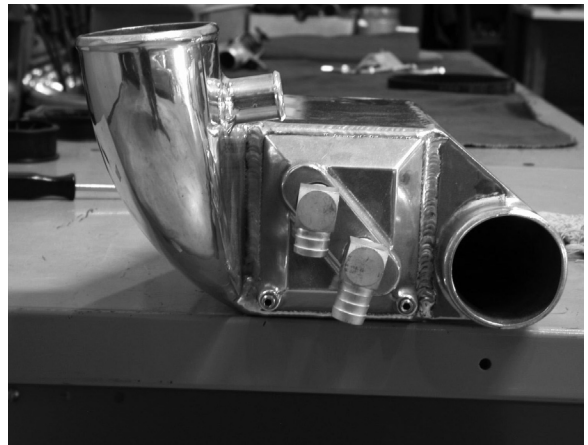

Fig. 8F-b

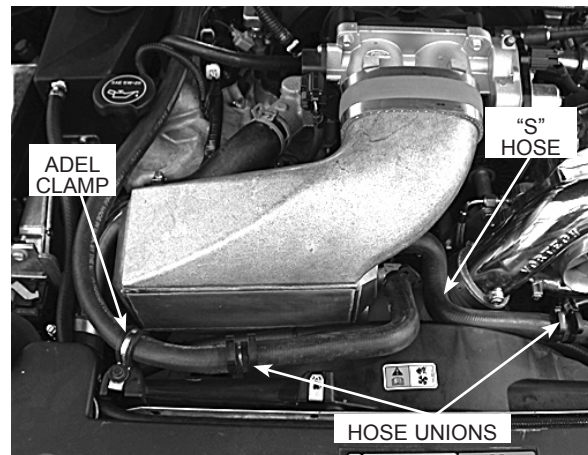

Fig. 8F-c

8. CHARGE AIR COOLER INSTALLATION (CHARGE COOLED KITS ONLY), cont'd

the top port on the CAC water cooler.

11. At this time, verify that all hose connections are secure using the nylon ratchet clamps provided.
12. **(2007-2010 Models Only)** To provide additional clearance for the CAC, you will need to cut the factory radiator hose approximately 4" from its connection at the radiator. Install the supplied $\text{\O}1.5$ " x 4" hose union and two #24 hose clamps. Adjust to allow CAC clearance and secure. (See Fig. 8F-c.)

G. COOLANT RESERVOIR FILL

1. Check to make sure all previously installed hose connections are secure.
2. Fill the engine cooling system through the Vortech supplied coolant reservoir using the factory coolant previously drained.
3. Locate the factory coolant reservoir cap removed in section 1 and install it on the Vortech supplied reservoir.
4. **(2005-2006 Only)** Once the coolant system is filled and all trapped air expelled, install the 1/8"NPT plug provided in the previously installed cross-over tube. Thread sealant should be used.
5. CAC cooling system.
 - a. Temporarily remove the 3/4" hose attached to the 3/4" x 90° fitting on the CAC surge tank.
 - b. Cap the open end of the 3/4" x 90° fitting using the provided vinyl cap.
 - c. Fill the CAC system using a 25%/75% antifreeze/water mix. Using a funnel, fill through the 3/4" hose removed from the surge tank fitting.
 - d. Fill the system until the coolant level reaches the surge tank.
 - e. Remove the vinyl cap from the surge tank fitting and reinstall the 3/4" hose previously removed and secure with the nylon ratchet clamp.
6. Reinstall the front bumper assembly including the foam inner bumper, all plastic splash panels and light connections in the reverse order removed.
2010 Models skip this step and see section 8H.

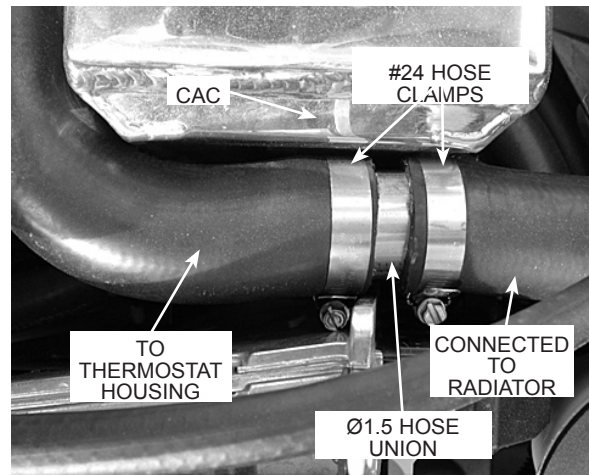

Fig. 8F-c (2007-10 MODELS ONLY)

8. CHARGE AIR COOLER INSTALLATION (CHARGE COOLED KITS ONLY), cont'd

H. BUMPER COVER MODIFICATION (2010 MODELS ONLY)

1. 2010 Models will require the removal of the lower grill uprights and certain surrounding areas to clear the water cooler. (See Fig. 8H-a)
2. Cut out vertical supports in lower grill opening. the upper lip of the grill should be trimmed back to approximately 4-1/4" when measured from the back side of the grill. (See Fig. 8H-b)
3. The lower lip should be trimmed back approximately 4-1/4" measured from the front of the grill. (See Fig. 8H-c)



Fig. 8H-a

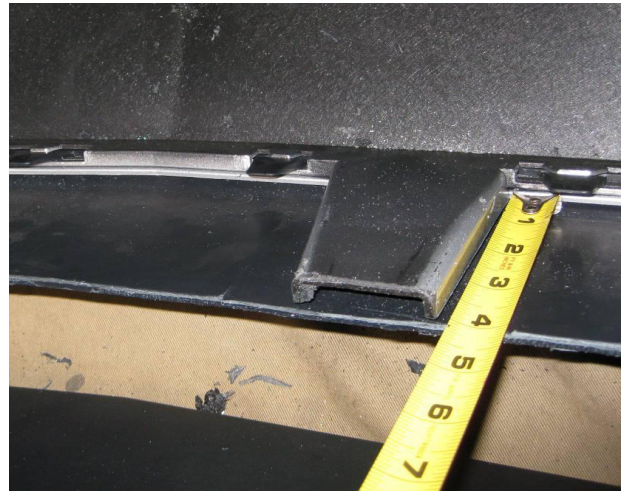

Fig. 8H-b

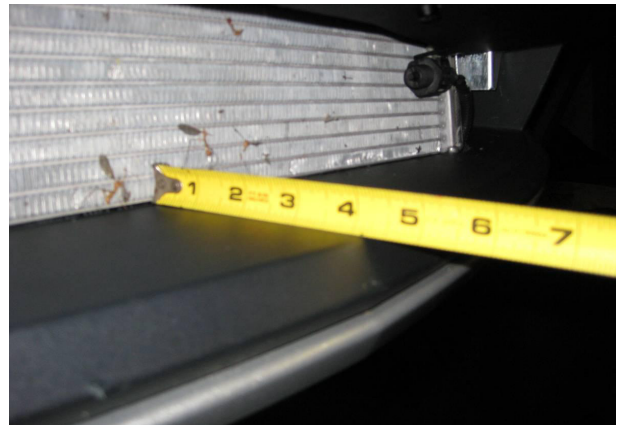

Fig. 8H-c

8. CHARGE AIR COOLER INSTALLATION (CHARGE COOLED KITS ONLY), cont'd

H. BUMPER COVER MODIFICATION (2010 MODELS ONLY) con'td

- 4.. Trial fit bumper and check for interference against intercooler. Additional removal of material may be required to clear the intercooler end tanks and brackets (See Fig 8H-d,e).
5. Remove bumper and mark on upper lip supports 1" from edge. Drill a 1/4 " hole from the top of the support through the lip of the grill. From the bottom drill a 5/16" hole through the lip only, being careful not to drill through the support. An angle drill using the shortest bit possible is recommended.
5. Install the supplied 1/4-20 Nylon shouldered bolts from the lip side so that the threads protrude through the supports and attach with the supplied 1-4/20 Nylock nut (See Fig. 8H-f). Do not over tighten nuts.
6. Reinstall the front bumper assembly including the foam inner bumper, all plastic splash panels and light connections in the reverse order removed. See Fig. 8H-g for final installation reference.

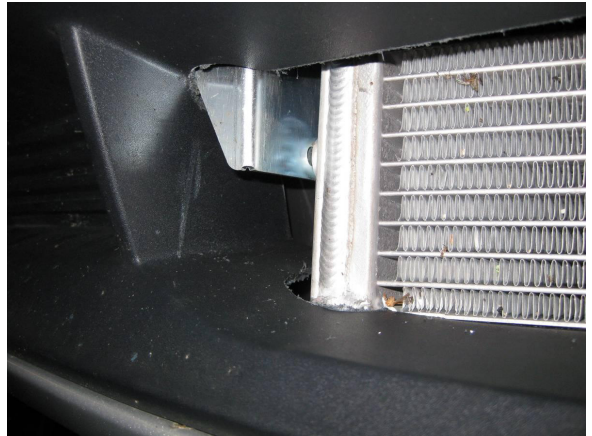

Fig. 8H-d

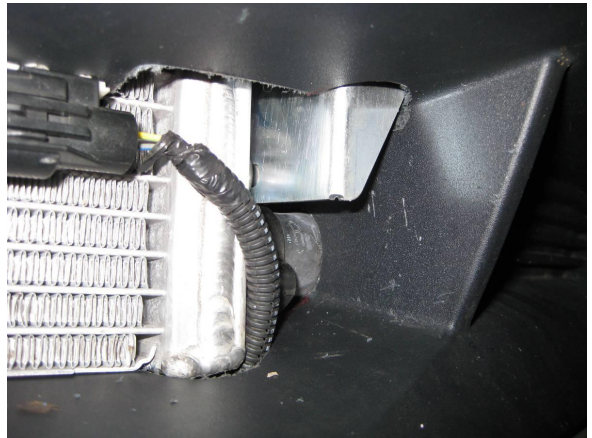

Fig. 8H-e



Fig. 8H-g



Fig. 8H-f

8. CHARGE AIR COOLER INSTALLATION (CHARGE COOLED KITS ONLY), cont'd

I. COMPRESSOR BYPASS VALVE INSTALLATION (V-POWER/BULLIT KITS SKIP TO 8J)

1. Assemble the bypass using a piece of 1" hose cut to 11" long and a piece cut to 13" long and four #16 hose clamps.
2. Attach the 11" piece of hose to the inlet of the bypass and secure with a clamp.
3. Secure the 13" piece to the outlet of the valve, securing it with a clamp. (See Fig. 8I.)
4. Attach the bypass assembly to the charge cooler. The 11" long piece will be attached to the charge cooler. Secure with clamps. Leave the 13" long section open for future attachment to the air inlet.
5. Attach a length of 5/32" vacuum hose to the bypass valve and route to the vacuum port of the fuel rail sensor.
6. Cut a section of the factory hose and install the vacuum TEE that is provided. (See Fig. 10-b)
7. Attach the vacuum hose from the bypass valve to the TEE.

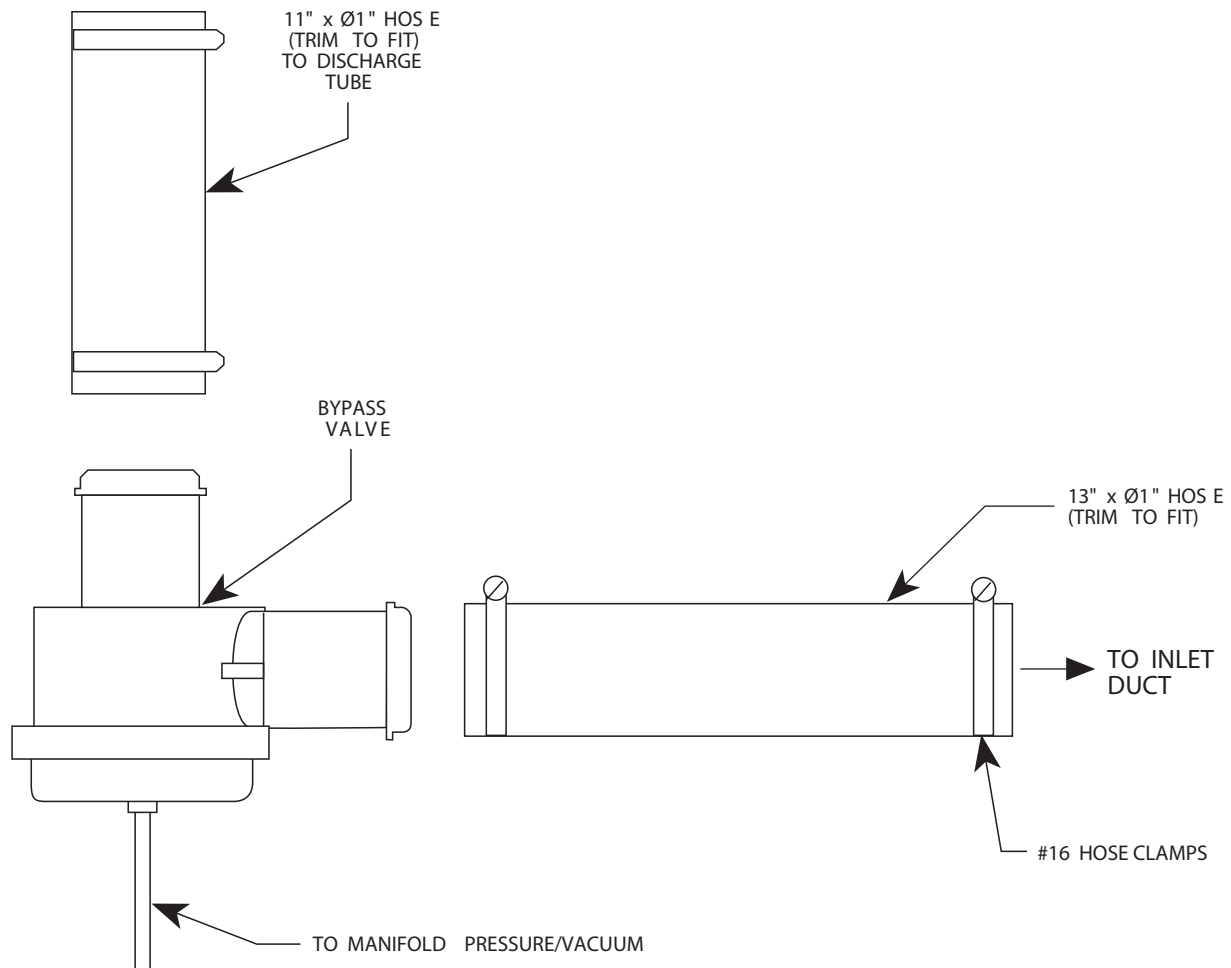

Fig. 8I

8. CHARGE AIR COOLER INSTALLATION (CHARGE COOLED KITS ONLY), cont'd

J. V-POWER/BULLIT COMPRESSOR BYPASS VALVE INSTALLATION

1. Assemble the bypass using the supplied Maxflow Race Bypass valve, $\text{\O} 1.75$ " silicone coupler with two #28 hose clamps, Bypass "Y", and two lengths of 1" hose cut to lengths of 16" and 17.5" with four #16 hose clamps. (See Fig. 8J)
2. Attach the Maxflow Race Bypass Valve to the flange located on the lower duct of the CAC using the supplied hardware and gasket.
3. Attach one end of the $\text{\O} 1.75$ " silicone coupler to the outlet of the bypass valve and secure with #28 hose clamp.
4. Insert the $\text{\O} 1.75$ " side of the bypass "Y" into the open end of the $\text{\O} 1.75$ " silicone coupler and secure with #28 hose clamp.
5. Secure the two lengths of 1" hose cut to 16" and 17.5" to the two outlets on the bypass "Y" with #16 hose clamps (See Figure 8I-a for orientation).
6. Leave the opposite ends of the 1" hose open for future attachment to the air inlet box.
7. Attach a length of $5/32$ " vacuum hose to the bypass valve and route to the vacuum port of the fuel rail sensor.
8. Cut a section of the factory hose and install the vacuum TEE that is provided (See Fig. 10-b).
9. Attach the vacuum hose from the bypass valve to the TEE

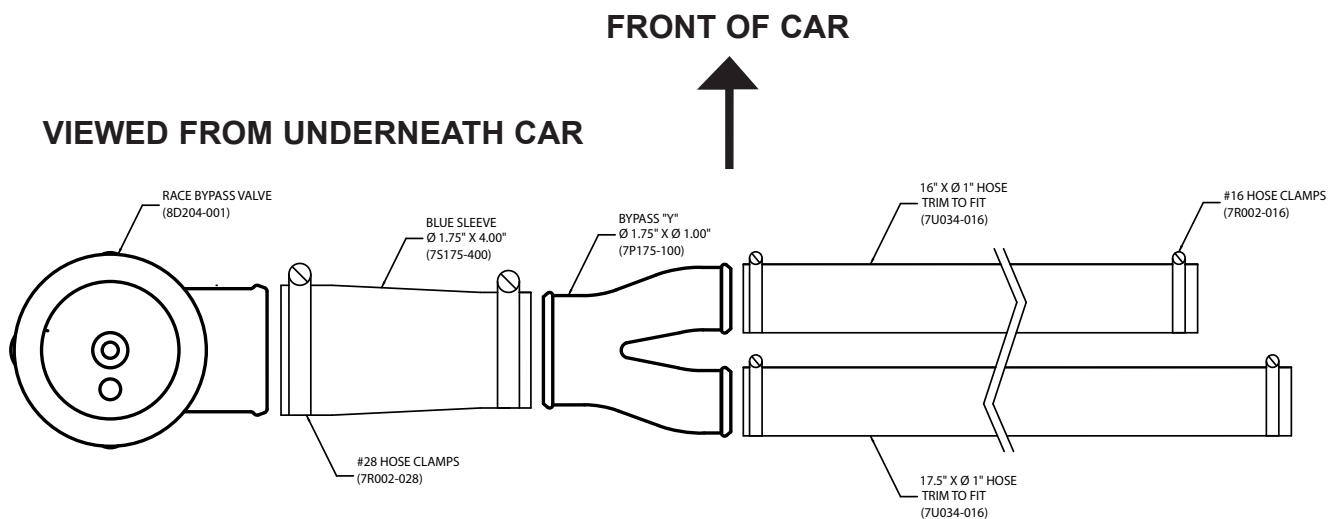

Fig. 8J

9. AIR DISCHARGE ASSEMBLY (Non-cooled kits only)

- A. Attach the 4.5" sleeve to the discharge duct with the #72 clamps provided.
- B. Install the 3.0" x 2.75" reducer to the inlet of the discharge duct and secure the #48 hose clamp provided.
- C. Install the duct to the inlet of the throttle body and the outlet of the supercharger. Secure the remaining #72, and #44 hose clamps provided. (See Fig. 9-a.)

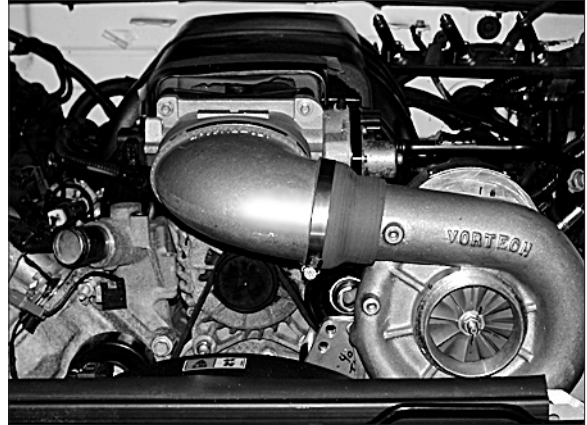

Fig. 9-a

10. COMPRESSOR BY-PASS VALVE INSTALLATION (Non-cooled kits only)

- A. Assemble the compressor by-pass valve by using a piece of 1" hose cut 15" long and a piece cut to 4.25" long, and four #16 hose clamps.
- B. Attach the 4.25" piece of hose to the inlet of the bypass and secure with a #16 clamp.
- C. Secure the 15" piece to the by-pass valve outlet using a #16 hose clamp. (See Fig. 10-a.)
- D. Attach the open end of the 4.25" hose to the boss on the air discharge duct. Secure with a #16 hose clamp. The open end of the 15" long hose will be connected to the air inlet in a future step.
- E. Secure all hoses with the clamps provided.
- F. Connect the supplied length of 5/32" vacuum to the port on the bypass valve. Route the line to the fuel regulator vacuum hose. Using the supplied vacuum TEE, connect the bypass vacuum line. (See Figs. 10-a, 10-b, for assistance.)

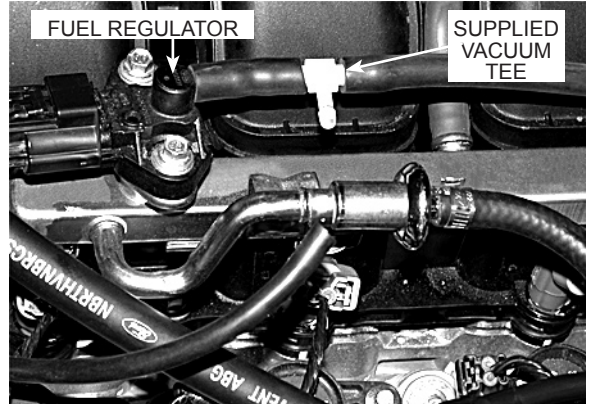

Fig. 10-b

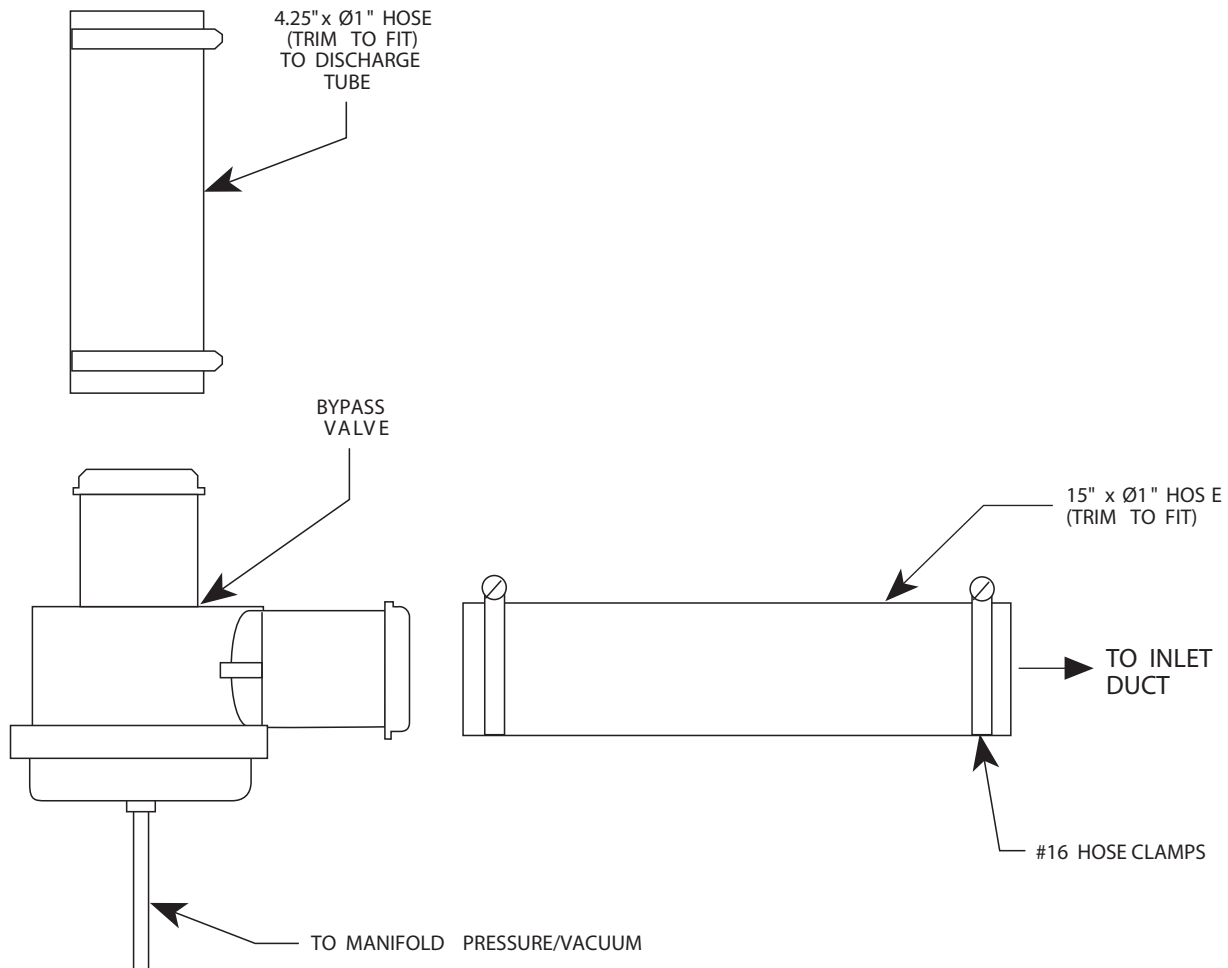

Fig. 10-a

11. COOLANT RESERVOIR RE-INSTALLATION (Non-cooled kits only)

- A. Reinstall the factory coolant reservoir using factory hardware to secure.
- B. Reattach the large hose at the bottom of the reservoir using the factory hose clamp.
- C. Reconnect the small overflow hose at the top using the factory clamps.
- D. Check all cooling system hose connections to make sure they are secured with the appropriate hose clamps.
- E. Refill the cooling system using the previously drained coolant.
- F. (2005-2006 Only) Once the coolant system is filled and all trapped air expelled, install the 1/8"NPT plug provided in the previously installed crossover tube. Thread sealant should be used.

12. CRANK CASE BREATHER AND PCV INSTALLATION

- A. Locate PVC/MAF assembly 4FU139-096.
- B. Install the hose assembly between the driver's side valve cover and the intake manifold. Secure hose connections as necessary using the supplied stepless clamps.
(See *Figs. 12-a, 12-b* for assistance.)
- C. Locate the factory 3/8" x 90° fitting removed from the passenger's side valve cover in a previous step.
- D. Connect the remainder of the supplied 3/8"ID hose to the 90° fitting and connect to the passenger's side valve cover. (See *Fig. 12-c.*)
- E. Route the open end of the 3/8" hose behind the alternator and across to where the air inlet duct will be located.

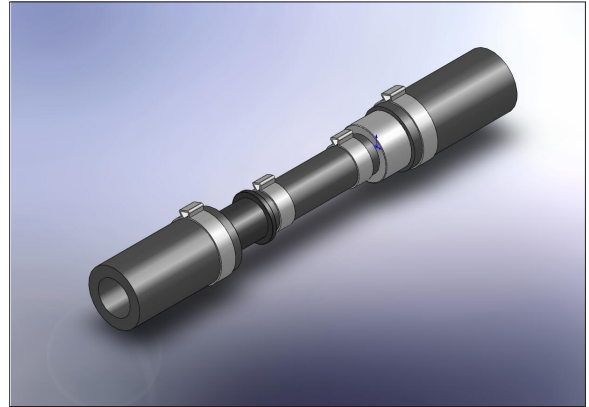

Fig. 12-a

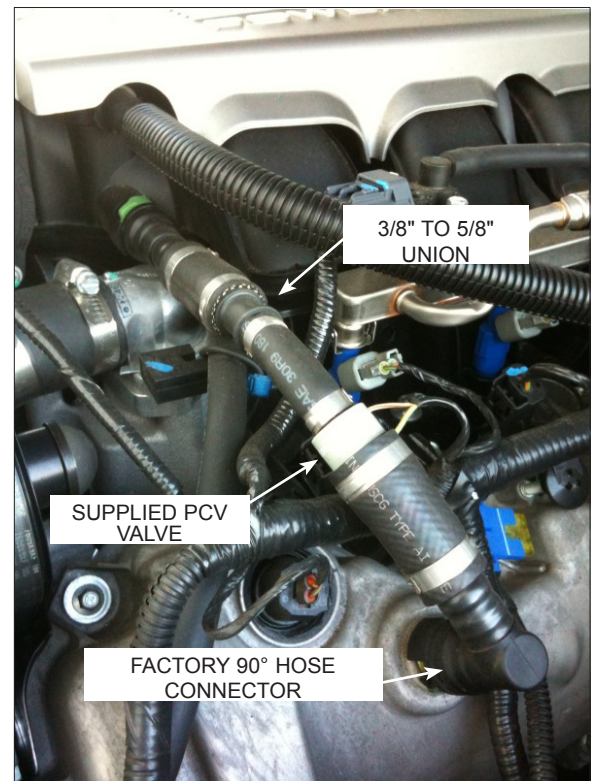

Fig. 12-b

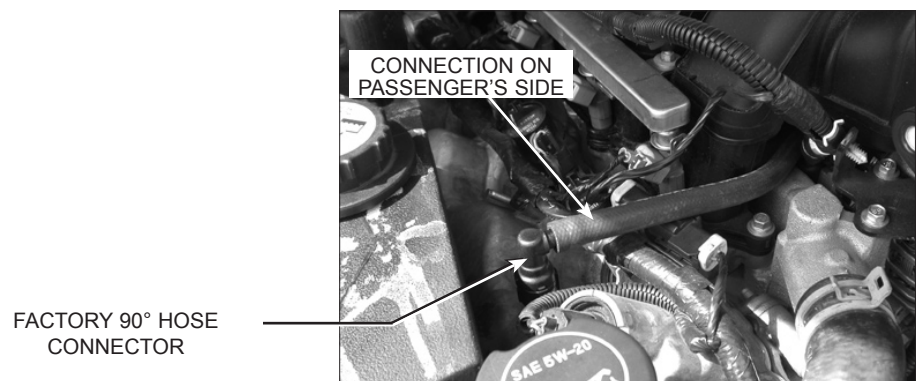

Fig. 12-c

13. AIR INLET ASSEMBLY

- A. Locate assembly 4FU112-010.
- B. Remove two of the 3/8-16 x 1" bolts securing the supercharger in place. Install the air inlet support bracket and secure with the 3/8" bolts removed from the supercharger mounting plate. (See Fig. 13-a.)
- C. Install the 3/4"NPT x 1" x 90° plastic fitting to the air inlet duct. (See Fig. 13-b.)
- D. Install the 1/4"NPT x 3/8" hose barb fitting in the location noted. (See Fig. 13-c.)
- D.2 (V-Power/Bullitt Kits Only) Drill out the second 3/4" NPT location on the air inlet duct using caution not to damage the threads and install the second 3/4" NPT x 1 x 90° plastic fitting to the air inlet duct. Orient both fittings as shown in Fig 13-d2.
- E. Attach the 4.0" x 3.5" reducer sleeve to the inlet duct. Secure the sleeves with the clamps provided. (See Fig. 13-d.)

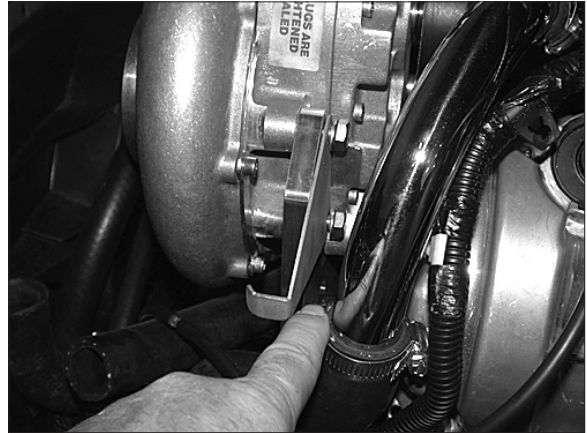

Fig. 13-a

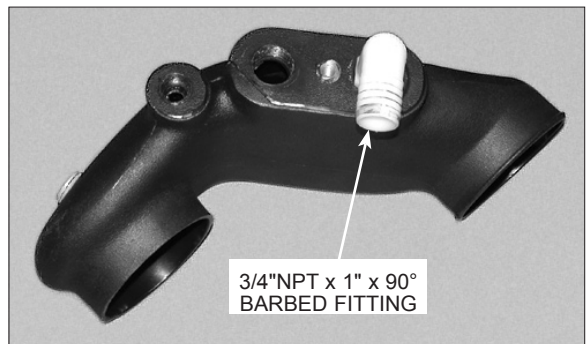

Fig. 13-b

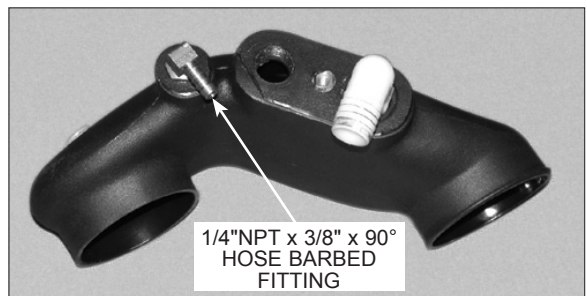

Fig. 13-c

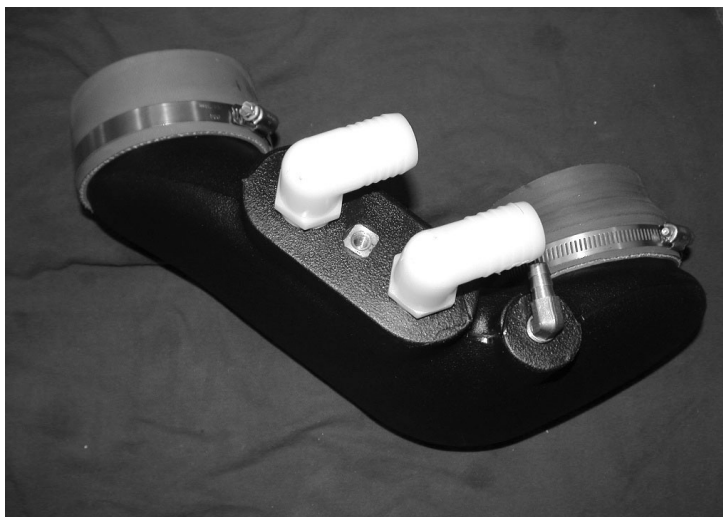

Fig. 13-d2 (V-Power/Bullitt Kits Only)



Fig. 13-d

13. AIR INLET ASSEMBLY, cont'd

- F. Attach the 3/8" hose previously connected to the passenger's side valve cover, to the 1/4"NPT x 3/8" hose x 90° fitting installed in a previous step.
- G. Attach the 1" bypass outlet hose to the 90° plastic fitting and secure the hose with a #16 hose clamp.
- H. Install the duct to the inlet of the supercharger and secure in place with the clamps provided.
- I. Locate and install a 4.0" x 2.0" long sleeve to the inlet of duct 4FU012-010 and secure with two #64 clamps. (See Fig. 13-e.)
- J. Remove the Factory MAF sensor element from the top portion of the air filter housing.
- K. Install the element using the 4mm hardware provided to the supplied MAF tube. (See Figs. 13-f, 13-g.)

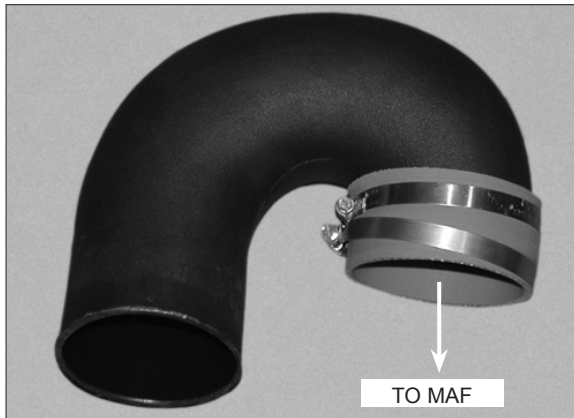

Fig. 13-e

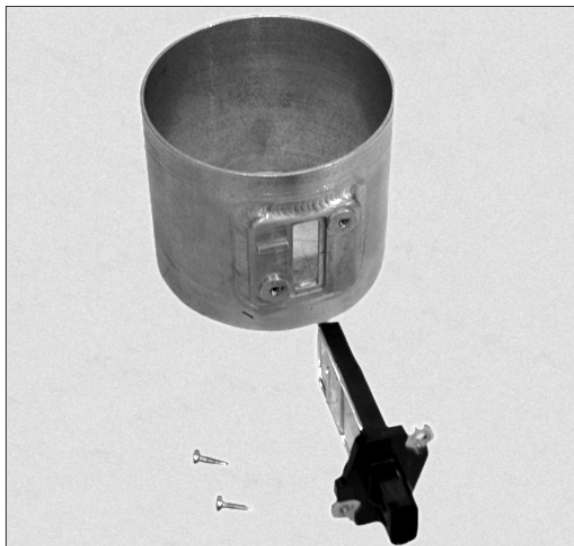

Fig. 13-f

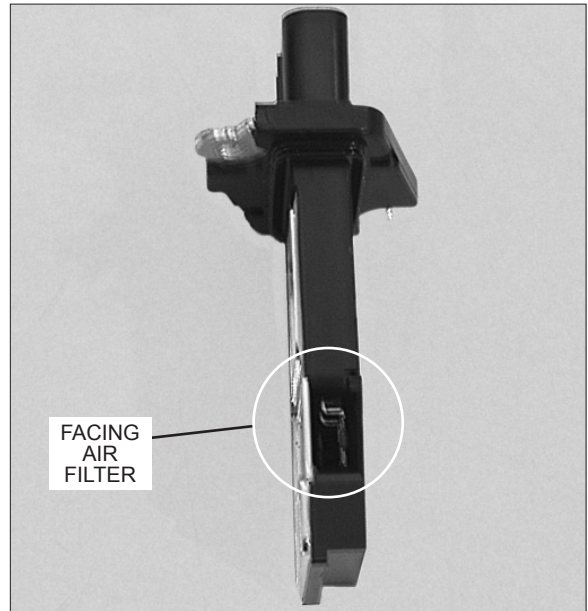

Fig. 13-g

NOTE: Install the MAF sensor element so the inlet of the sensor faces the air filter. (See Fig. 10-h.)

- L. Install the MAF sensor and air filter to the 180° duct. (See Fig. 13-h.)
- M. Install the 180° duct and the MAF sensor with filter to the inlet duct leading to the Supercharger. (See Fig. 13-i.) Clock the MAF *exactly* as shown. (See Fig. 13-i.)
- N. Secure the rear clamp at the inlet duct union to the previously installed support bracket. (See Fig. 13-i.)
- O. MAF (Mass Air Meter) (Non-Cooled Kits Only) Harness Extension:
 - 1. Locate the supplied wire and butt connectors in assembly 4FU101-001.

13. AIR INLET ASSEMBLY, cont'd

NOTE: It is strongly recommended that the wires be soldered. Temporary solderless connectors have been provided in case you are unable to solder.

2. Remove the split loom from the factory wires on the MAF sensor.
3. Cut the wires to the connector approximately 2" from the plug.
4. Using the supplied connectors and wire, extend the connector to the MAF.
5. Install the supplied 3/8" split-loom to the extended sensor plug harness. Secure the split-loom with wire-ties or tape.
6. Route the lengthened wires and connector to the MAF, keeping the wires away from hot or moving parts.

P. MAF Interface Adapter Installation (*Charge Cooled kits only*)

1. Locate the MAFia (*Interface Adapter*) box.
2. Plug the MAFia in between the factory MAF connector and the MAF sensor.
3. Remove the small red cover in the middle of the supplied MAFia box.
4. Verify that the MAFia box is set on number "2".
5. If you find that the MAFia box is not set, use the tool that is provided with the MAF Interface Adapter box and set to the number "2".
6. Replace the cover and secure the MAFia box and set to the number "2".

NOTE: It is critical that the MAF Interface Adapter box be set on number "2". The calibration that is provided with this kit has been created to work at this setting. Any change to the MAF Interface Adapter box by setting it to a higher or lower number could cause damage to the engine.

- Q. On 2010 models it will be necessary to bend the hood latch cable bracket 90° for air filter clearance.(See Fig 13-j)



Fig. 13-h

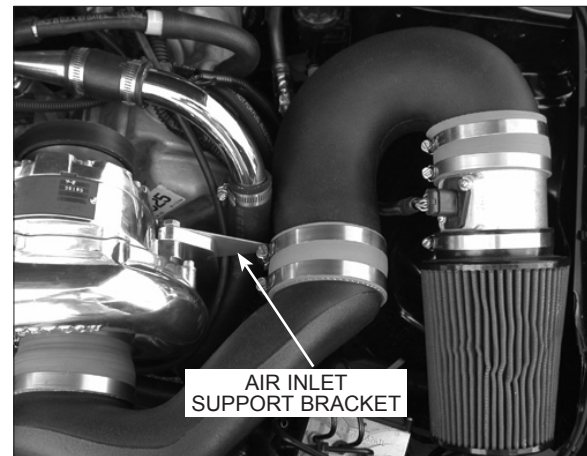

Fig. 13-i

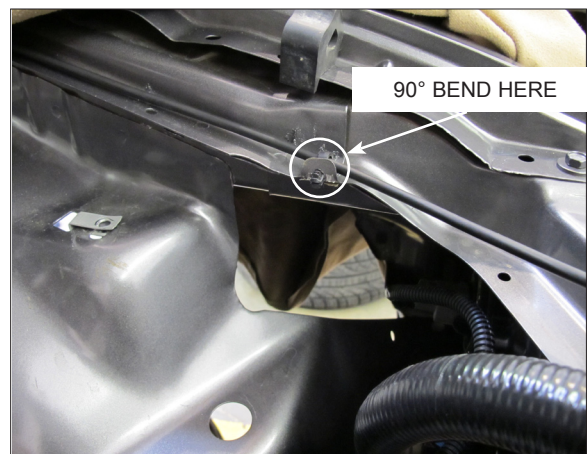

Fig. 13-j

14. FUEL PUMP UPGRADE

NOTE: This section is best performed with the fuel level BELOW half a tank.

- A. Remove the rear seat by depressing the two release buttons at the front edge of the seat. (See Fig. 14-a.)
- B. Remove the round plastic inspection cover on the driver's side. (See Fig. 14-b.)
- C. Unplug the sending unit harness and disconnect the fuel line connection.
- D. Using a small screwdriver or chisel and hammer, tap the retaining ring in a counter clockwise direction. Remove the retaining ring and set aside. (See Fig. 14-b.)
- E. Slowly pull the fuel pump assembly up. Locate the crossover fuel line connection on the fuel pump assembly and disconnect. (See Fig. 14-c.)
- F. Remove the pump assembly from the tank being careful not to damage or lose the rubber O-ring.
- G. Carefully cut the step-less clamps securing the short corrugated fuel line between the fuel pump outlet and distribution rail. Remove the fuel line and discard. (See Fig. 14-d.)

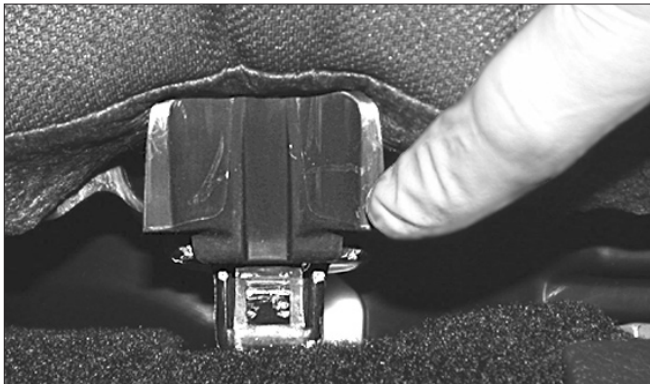

Fig. 14-a

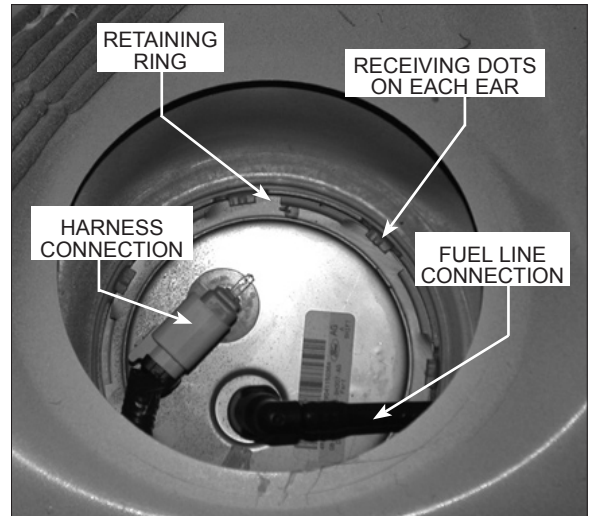

Fig. 14-b

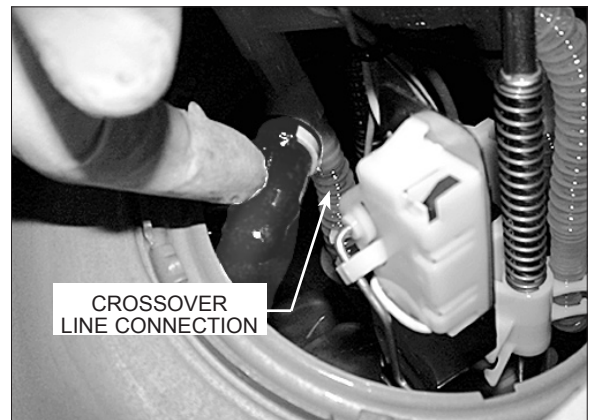

Fig. 14-c

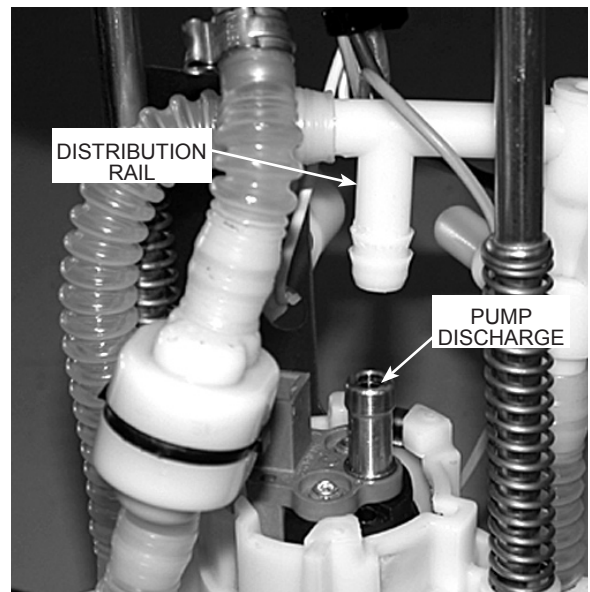

Fig. 14-d

14. FUEL PUMP UPGRADE, cont'd

- H. Using the supplied 17.0 stepless clamps and 2.75" length of $\text{Ø}3/8$ " rubber hose, connect the supplied "Y" fitting to the distribution rail. (See Fig. 14-e.)
- I. Locate the supplied fuel pump and pump inlet screen. Attach the pump inlet screen to the pump and orient exactly as shown. (See Fig. 14-f.)
- J. Secure the supplied fuel pump to the side of the factory pump assembly using the #44 hose clamp supplied. Verify that the hose clamp is routed inside of the metal posts so that they can be pushed down without restriction. (See Fig. 14-f.)
- K. Slide the two supplied .75" long teflon sleeves over the discharge of each fuel pump. (See Fig. 14-g.)

NOTE: The supplied 1.5" long Teflon tube will need to be cut into two .75" long pieces.

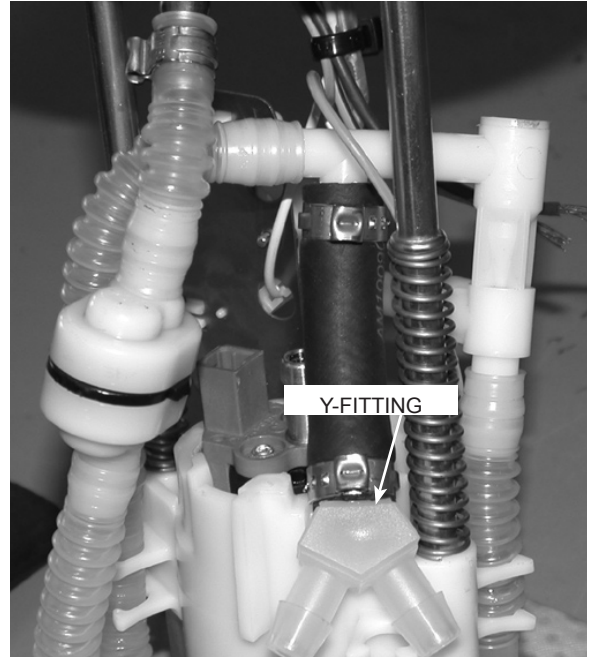

Fig. 14-e

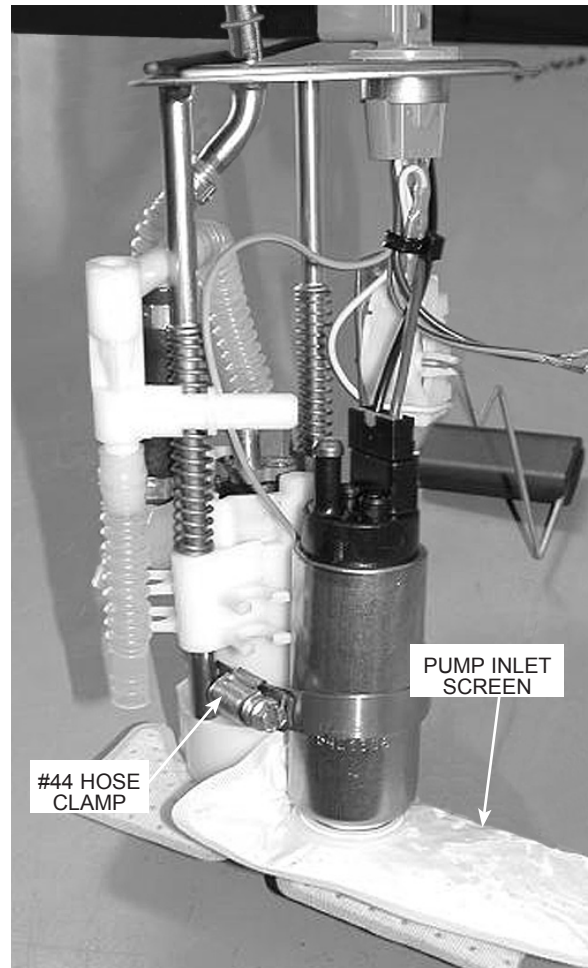

Fig. 14-f

14. FUEL PUMP UPGRADE, cont'd

- L. Slide the supplied 11.3 stepless clamps onto the two open legs of the Y-fitting. Connect the discharge of both pumps to the previously installed "Y" fitting using the two supplied $\text{\O}3/8$ " corrugated teflon hoses. Secure the remaining hose ends using the supplied 11.3 stepless clamps. (See Fig. 14-h.)
- M. Secure all hoses to the fuel pump assembly using the supplied ties. Make sure the lid is able to spring up and down without restriction and that the hoses do not kink. (See Fig. 14-h.)
- N. Use the supplied T-splice and slide connectors to connect the black and red wires from the supplied pump to the corresponding power and ground on the factory pump. (See Fig. 14-h.)
- O. Reinstall the fuel pump assembly into the fuel tank in the reverse order of removal. Ensure that the fuel hoses do not rub on the sharp edges of the fuel tank. Take care not to damage the assembly. **INSTALLATION WILL BE TIGHT.** Connect all fuel and electrical connections. Verify that the fuel gauge float is able to move freely. Make sure the O-ring seal is in place and not damaged. There is an alignment arrow on the pump assembly top that will need to be aligned with the dot on the fuel tank. (See Fig. 14-b.)

NOTE: Retaining ring indents must engage their receivers for proper seal. (See Fig. 14-b.)

- P. Locate the power distribution box located on the passenger's side of the engine compartment. Verify the #41 fuse is for the fuel pump. (2010 Model year uses #13) Replace the factory 15AMP fuse with the supplied 20AMP fuse.
- Q. Cycle the ignition key and check for any fuel leaks, verify proper fuel gauge operation.
- R. Reinstall the plastic inspection cover and rear seat.

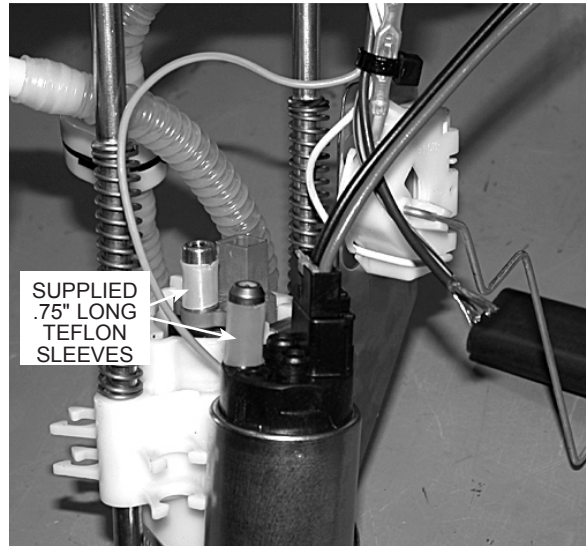

Fig. 14-g

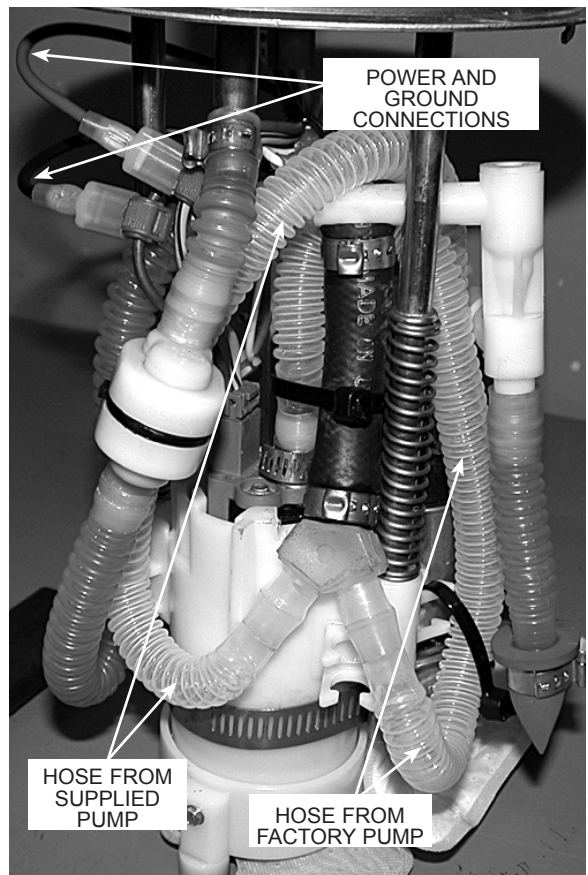

Fig. 14-h

15. REFLASH COMPUTER

IMPORTANT! To ensure trouble-free programming of your vehicle's computer:

- Make sure the vehicle's battery is sufficiently charged.
- Turn off all accessories and close doors to prevent unnecessary drain on the battery.
- Do not attempt to program your vehicle while a battery charger is connected.
- Improper battery voltage will result in failure of the programming process.
- Do not disconnect the cable or turn off the ignition during programming.

- Reconnect the battery.
- Locate the vehicle's OBD2 connector located in the lower left hand corner of the dash on the driver's side of the vehicle. (See Fig 15-a.)
- Attach the OBD2 connector from the Flash tool (provided in the kit) to the vehicle's OBD2 port. (See Fig 15-b.) Make sure this connector is seated all the way into the vehicle's OBD2 port. You do not want this connector coming out during programming or damage may occur to the vehicle's ECM.
- The Reflash tool should power up and display three parameters:
 - Performance Tune
 - Diagnostics
 - Options
- Select "Performance Tune" and press the enter button in the middle of the arrow keys. (See Fig 15-c.)
- Read the disclaimer entirely, then select agree and press ENTER.
- At this point please read the screen displayed on the reflash tool. If you have any questions, either refer to the manual provided with the reflash tool or contact our service department for further assistance.
- Turn the ignition on (*do not start the vehicle*). Set the parking brake and press the "ENTER" button to continue.
- "SELECT TUNE" will be displayed at the top of the screen. Use the arrow keys to select the appropriate tune for your vehicle and press the ENTER button. You will have four choices to select from:
 - STD OUTPUT (non charge-cooled)
 - Charge-cooled, air/water
 - Charge-cooled, air/air (*this option is NOT used in this application*)
 - Original Backup
- Continue to follow the screen and when finished unplug the reflash tool from the vehicles OBD2 port.



Fig. 15-a

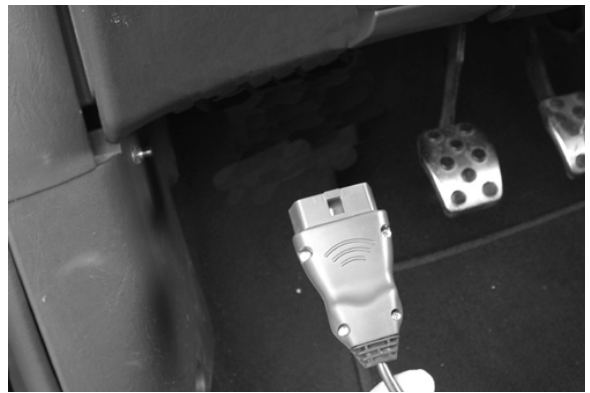

Fig. 15-b



Fig. 15-c

NOTE: Do not disturb the cable, or turn the ignition off during this time. If the programming is disrupted, the computer will not start or run your vehicle!

16. FINAL CHECK

WARNING: Do not attempt to operate the vehicle until all components are installed and all operations are completed including the final check.

- A. If your vehicle has gone over 15,000 miles since its last spark plug change, you will need to change the spark plugs now *before* test driving the vehicle.
- B. Check all fittings, nuts, bolts and clamps for tightness. Pay particular attention to oil and fuel lines around moving parts, sharp edges and exhaust system parts. Make sure all wires and lines are properly secured with clamps or tie-wraps.
- C. Check all fluid levels, making sure that your tank(s) is/are filled with 91 octane or higher fuel before commencing test drive.
- D. Start the engine and allow to idle a few minutes, then shut off.

H.O Charge Cooled Kits Only

NOTE: Check to see that CAC coolant is flowing through the surge tank. If coolant is not flowing, remove the 3/4" rubber hose from the side of the surge tank and apply light suction in an attempt to pass any trapped air in the system. Reconnect the hose and recheck coolant flow.

- E. Recheck to be sure that no hoses, wires, etc. are near exhaust headers or moving parts. Look also for any signs of fluid leakage.
- F. **PLEASE TAKE SPECIAL NOTE:** Operating the vehicle without ALL the subassemblies completely and properly installed may cause **FAILURE OF MAJOR COMPONENTS.**
- G. Test drive the vehicle.
- H. Always listen carefully for engine detonation. Discontinue heavy throttle usage if detonation is heard.
- I. Read the **STREET SUPERCHARGER SYSTEM OWNER'S MANUAL AND RETURN THE WARRANTY REGISTRATION FORM** within thirty (30) days of purchasing your supercharger system to qualify.

For internally lubricated V3 units only

This supercharger has been factory pre-filled with special Vortech synthetic lubricant. Oil does not need to be added to a brand new unit; however a fluid level check should be performed.

Prior to operating the supercharger on the vehicle and after installation onto the vehicle:

Remove the factory installed flat-head brass shipping plug (not the dipstick) from the top of the supercharger case. Replace the sealed shipping plug with the supplied "vented" plug. Do not operate the supercharger without it. Check the supercharger fluid level.

Fluid level checking procedure:

1. Ensure that the .06" copper sealing washer is located on the dipstick base.
2. Thread the clean dipstick into the unit until it seats.
3. Once the dipstick has seated, remove the dipstick from the unit. Fluid should register in the crosshatched area on the dipstick.
4. **DO NOT OVERFILL!!!** Drain excess fluid from the unit if it is above the maximum level on the dipstick.

Check the fluid level using the dipstick at least every 2,500 miles.

Initial supercharger fluid change must be performed at 2,500 miles. The supercharger fluid must be changed at least every 7,500 miles.

Drain the fluid, refill the unit with 4 oz. of Vortech V3 lubricating fluid and then confirm proper oil level using the dipstick. **DO NOT OVERFILL!!!**

WARNING: Use of any other fluid other than the special Vortech lubricant will void the warranty and may cause component failure.



ENGINEERING, LLC

1650 Pacific Avenue, Channel Islands CA 93033-9901 • Phone: 805 247-0226
Fax: 805 247-0669 • www.vortechsuperchargers.com • M-F 8:00AM - 4:30PM (PST)